



# Operation Manual

PRODUCT NAME

Digital Flow Switch

MODEL/ Series/ Product Number

*PF3A703H*

*PF3A706H*

*PF3A712H*

**SMC Corporation**

## Table of Contents

Safety Instructions	2
Model Indication and How to Order	10
Names and Functions of Individual Parts	11
Definition and terminology	12
Mounting and Installation	14
Installation	15
Piping method	16
Wiring	17
Outline of Settings [Measurement mode]	21
Change of Set Value [3 step setting mode]	22
Default setting	22
Change of Set Flow and Hysteresis [Simple setting mode]	25
Change the Function Settings [Function selection mode]	27
Function selection mode	27
Default setting	28
F0 Reference condition/ Units selection function	29
F1 Setting of OUT	31
F3 Response time	40
F5 FUNC setting	41
F10 Sub display setting (Line name setting)	44
F13 Setting for reverse display mode	45
F14 Zero cut-off setting	46
F30 Setting of accumulated value holding time	50
F80 Set display OFF mode	51
F81 Security code	52
F90 Setting of all functions	54
F96 Check of input signal	56
F98 Setting of output check	57
F99 Reset to the default settings	59
Other Settings	60
Maintenance	63
Forgotten the Security Code	63
Troubleshooting	64
Error display	68
Specifications	69
Characteristics data	72
Dimensions	75



# Safety Instructions

These safety instructions are intended to prevent hazardous situations and/or equipment damage. These instructions indicate the level of potential hazard with the labels of "Caution", "Warning" or "Danger". They are all important notes for safety and must be followed in addition to International Standards (ISO/IEC)\*1, and other safety regulations.

\*1) ISO 4414: Pneumatic fluid power -- General rules relating to systems.

ISO 4413: Hydraulic fluid power -- General rules relating to systems.

IEC 60204-1: Safety of machinery -- Electrical equipment of machines .(Part 1: General requirements)

ISO 10218: Manipulating industrial robots -Safety.

etc.



## Caution

**Caution** indicates a hazard with a low level of risk which, if not avoided, could result in minor or moderate injury.



## Warning

**Warning** indicates a hazard with a medium level of risk which, if not avoided, could result in death or serious injury.



## Danger

**Danger** indicates a hazard with a high level of risk which, if not avoided, will result in death or serious injury.

## Warning

### 1. The compatibility of the product is the responsibility of the person who designs the equipment or decides its specifications.

Since the product specified here is used under various operating conditions, its compatibility with specific equipment must be decided by the person who designs the equipment or decides its specifications based on necessary analysis and test results.

The expected performance and safety assurance of the equipment will be the responsibility of the person who has determined its compatibility with the product.

This person should also continuously review all specifications of the product referring to its latest catalog information, with a view to giving due consideration to any possibility of equipment failure when configuring the equipment.

### 2. Only personnel with appropriate training should operate machinery and equipment.

The product specified here may become unsafe if handled incorrectly.

The assembly, operation and maintenance of machines or equipment including our products must be performed by an operator who is appropriately trained and experienced.

### 3. Do not service or attempt to remove product and machinery/equipment until safety is confirmed.

1. The inspection and maintenance of machinery/equipment should only be performed after measures to prevent falling or runaway of the driven objects have been confirmed.

2. When the product is to be removed, confirm that the safety measures as mentioned above are implemented and the power from any appropriate source is cut, and read and understand the specific product precautions of all relevant products carefully.

3. Before machinery/equipment is restarted, take measures to prevent unexpected operation and malfunction.

### 4. Contact SMC beforehand and take special consideration of safety measures if the product is to be used in any of the following conditions.

1. Conditions and environments outside of the given specifications, or use outdoors or in a place exposed to direct sunlight.

2. Installation on equipment in conjunction with atomic energy, railways, air navigation, space, shipping, vehicles, military, medical treatment, combustion and recreation, or equipment in contact with food and beverages, emergency stop circuits, clutch and brake circuits in press applications, safety equipment or other applications unsuitable for the standard specifications described in the product catalog.

3. An application which could have negative effects on people, property, or animals requiring special safety analysis.

4. Use in an interlock circuit, which requires the provision of double interlock for possible failure by using a mechanical protective function, and periodical checks to confirm proper operation.



# Safety Instructions

## Caution

### **1. The product is provided for use in manufacturing industries.**

The product herein described is basically provided for peaceful use in manufacturing industries. If considering using the product in other industries, consult SMC beforehand and exchange specifications or a contract if necessary.  
If anything is unclear, contact your nearest sales branch.

## Limited warranty and Disclaimer/Compliance Requirements

The product used is subject to the following "Limited warranty and Disclaimer" and "Compliance Requirements".

Read and accept them before using the product.

### Limited warranty and Disclaimer

**1. The warranty period of the product is 1 year in service or 1.5 years after the product is delivered, whichever is first.\*2)**

Also, the product may have specified durability, running distance or replacement parts. Please consult your nearest sales branch.

**2. For any failure or damage reported within the warranty period which is clearly our responsibility, a replacement product or necessary parts will be provided.**

This limited warranty applies only to our product independently, and not to any other damage incurred due to the failure of the product.

**3. Prior to using SMC products, please read and understand the warranty terms and disclaimers noted in the specified catalog for the particular products.**

**\*2) Vacuum pads are excluded from this 1 year warranty.**

A vacuum pad is a consumable part, so it is warranted for a year after it is delivered.

Also, even within the warranty period, the wear of a product due to the use of the vacuum pad or failure due to the deterioration of rubber material are not covered by the limited warranty.

### Compliance Requirements

**1. The use of SMC products with production equipment for the manufacture of weapons of mass destruction (WMD) or any other weapon is strictly prohibited.**

**2. The exports of SMC products or technology from one country to another are governed by the relevant security laws and regulation of the countries involved in the transaction. Prior to the shipment of a SMC product to another country, assure that all local rules governing that export are known and followed.**

## Caution

### **SMC products are not intended for use as instruments for legal metrology.**

Products that SMC manufactures or sells are not measurement instruments that are qualified by pattern approval tests relating to the measurement laws of each country.

Therefore, SMC products cannot be used for business or certification ordained by the measurement laws of each country.

## ■ Operator

- ◆ This Operation Manual is intended for those who have knowledge of machinery using pneumatic equipment, and have sufficient knowledge of assembly, operation and maintenance of such equipment.  
Only those persons are allowed to perform assembly, operation and maintenance.
- ◆ Read and understand this Operation Manual carefully before assembling, operating or providing maintenance to the product.

## ■ Safety Instructions

### Warning

- Do not disassemble, modify (including the replacement of board) or repair.  
Otherwise, an injury or failure can result.
- Do not operate the product outside of the specifications.  
Do not use the product with flammable or harmful fluids.  
Fire, malfunction, or damage to the product may result.  
Check the specifications before use.
- Do not use in an environment where flammable, explosive or corrosive gases are present.  
Otherwise, fire, explosion or corrosion may occur.  
The product is not designed to be explosion proof.
- Do not use the product with flammable fluid  
Fire or an explosion may result.  
Only air and N<sub>2</sub> are applicable.
- Do not use the product in a place where static electricity is a problem.  
Otherwise failure or malfunction of the system can result.
- If using the product in an interlocking circuit
  - Provide a double interlocking system, for example a mechanical system.
  - Check the product regularly for proper operation.Otherwise malfunction can result, causing an accident.
- The following instructions must be followed during maintenance
  - Turn off the power supply.
  - Stop the air supply, exhaust the residual pressure in piping and verify that the air is released before performing maintenance work.Otherwise an injury can result.

## Caution

- Do not touch the terminals and connectors while the power is on.  
Otherwise electric shock, malfunction and damage to the product can result.
- After maintenance is complete, perform appropriate functional inspections and leak test.  
Stop operation if the equipment does not function properly or there is leakage of fluid.  
When leakage occurs from parts other than the piping, the product itself may be damaged.  
Cut off the power supply and stop the fluid supply.  
Do not apply fluid if the system is leaking.  
Otherwise, an unexpected malfunction may occur and it will become impossible to ensure safety.

### ■ Handling Precautions

- Follow the instructions given below for selecting and handling.
  - The instructions on design and selection (installation, wiring, environment, adjustment, operation, maintenance, etc.) described below must be followed.
    - \* Product specifications
      - Use the specified voltage.  
Otherwise failure or malfunction can result.  
Insufficient supply voltage may not drive a load due to a voltage drop inside the product.  
Check the operating voltage of the load before use.
      - Do not apply a load that exceeds the max. load voltage or current.  
This may cause damage or shorten the lifetime of the product.
      - Data stored by the product is not deleted, even if the power supply is cut off.  
(Limit to rewrite: 1,500,000 times)
      - The applicable fluids for this product are dry air and N<sub>2</sub>.  
The operating fluid temperature range is 0 to 50 °C.
      - Before designing piping confirm the pressure loss (Characteristic data) at the sensor from the pressure loss graph. Confirm pressure loss of the sensor from the characteristics data.
      - For the details of compressed air quality, refer to JIS B 8392: 2012[3: 6: -].
      - Use within the specified measurement flow rate and operating pressure.  
Otherwise it will not be able to perform proper measurement due to delivery delay of the fluid.
      - Reserve a space for maintenance.  
Design the system allowing the required space for maintenance.

● **Product handling**

\* **Mounting**

- Tighten to the specified tightening torque.  
If the tightening torque is exceeded, the product can be damaged.  
Insufficient torque can cause displacement of the product from its proper position and the looseness of the mounting screws.
  - If a commercially available switching power supply is used, be sure to ground the frame ground (FG) terminal.
  - Do not drop, hit or apply excessive shock to the product.  
Otherwise damage to the internal components may result, causing malfunction.
  - Do not pull the lead wire forcefully, or lift the product by the lead wire.  
(Tensile strength 49 N or less)  
Hold the product by the body when handling to prevent damage.
  - When connecting the piping, hold the piping and a part of the metal area with a spanner.  
Holding other parts of the product with a spanner may damage the product.
  - Any dust left in the piping should be flushed out by air blow before connecting the piping to the product.  
Otherwise it can cause damage or malfunction.
  - Refer to the flow direction of the fluid indicated on the product label for installation and piping.
  - Do not mount the body with the bottom facing upwards. Retention of air can cause inability to measure accurately.  
Retention of air can cause inability to measure accurately.
  - Do not insert metal wires or other foreign matter into the flow path.  
This can damage the sensor causing failure or malfunction.
  - Never mount the product in a place that will be used as a scaffold during piping.  
The product may be damaged if excessive force is applied by stepping or climbing onto it.
  - Do not apply excessive rotation force to the monitor.  
The monitor with integrated display can be rotated 90° clockwise.  
Rotating the display with excessive force will damage the end stopper.
  - Visibility decreases if the display is viewed from the opposite side to the buttons.  
Check the settings and display from in front of the display.
  - If there is a risk of foreign matter entering the fluid, install a filter of mist separator at the inlet to avoid failure and malfunction.  
Otherwise it can cause damage or malfunction. Or the flow switch will become unable to measure accurately.  
Air quality specified in the product specifications can be satisfied by using the pneumatic circuit below.
  - Do not connect equipment or piping which may generate a fluctuation in the flow or drift at the IN side of the product.  
When installing the regulator at the IN side of the product, make sure that hunting is not generated.
  - The piping on the IN side must have a straight section of piping whose length is 8 times the piping I.D. or more. If a straight section of piping is not installed, the accuracy will vary by more than ±3%F.S.
- \*: "Straight section" means a section of the piping without any bends or rapid changes in the cross sectional area.

**Recommended pneumatic circuit example (for compressed air)**

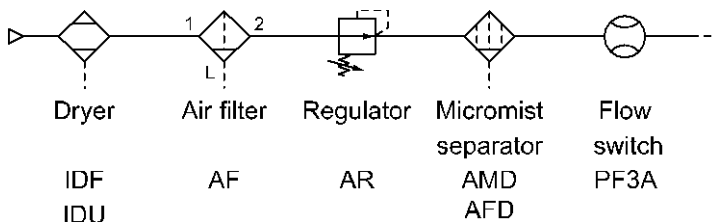

\*Wiring (Including connecting/ disconnecting of the connectors)

- Do not pull hard on the lead wire. Especially never lift the product equipped with fitting and piping by holding the lead wires.

Damage to the connector, circuit board, cover or internal components may result, causing failure or malfunction.

- Avoid repeatedly bending, stretching or applying a heavy object or force to the lead wire.

Repetitive bending stress or tensile stress can cause the sheath of the wire to peel off, or breakage of the wire.

If the lead wire can move, secure it near the body of the product.

The recommended bend radius of the lead wire is 6 times the outside diameter of the sheath, or 33 times the outside diameter of the insulation material, whichever is larger.

Replace the damaged lead wire with a new one.

- Wire correctly.

Incorrect wiring may cause malfunction or damage to the product.

- Do not perform wiring while the power is on.

Otherwise damage to the internal components may result, causing malfunction.

- Do not route wires and cables together with power or high voltage cables.

Route the wires of the product separately from power or high voltage cables to prevent noise and surge from entering the product.

- Confirm correct insulation of wiring.

Poor insulation (interference with other circuits, poor insulation between terminals etc.) can apply excessive voltage or current to the product causing damage.

- Keep wiring as short as possible to prevent interference from electromagnetic noise and surge voltage.

Do not use a cable longer than 30 m.

Wire the DC(-) line (blue) as close as possible to the power supply.

- When analogue output is used, install a noise filter (line noise filter, ferrite element, etc.) between the switch-mode power supply and the product.



#### \*Operating environment

- Do not use the product in an environment where the product is constantly exposed to water splashes. Otherwise failure or malfunction can result. Take measures such as using a cover.
- Do not use the product in an environment where corrosive gases or fluids can be splashed. Otherwise damage to the internal parts can result, causing malfunction.
- Do not use the product in a place where the product could be splashed by oil or chemicals. If the product is to be used in an environment containing oils or chemicals such as coolant or cleaning solvent, even for a short time, it may be adversely affected (damage, malfunction, or hardening of the lead wires).
- Do not use in an area where surges are generated. When there are machines or equipment that generate large surges near the product (magnetic type lifter, high frequency inductive furnace, motor, etc.), this can result in deterioration and damage of the internal components. Take protective measures to isolate the surge sources, and prevent the lines from coming into close contact.
- Do not use a load which generates surge voltage. When a surge-generating load such as a relay or solenoid is directly driven, use the product with built in surge protection.
- The product is CE marked, but not immune to lightning strikes. Take measures against lightning strikes in the system.
- Mount the product in a location that is not affected by vibration or impact. Otherwise it can cause damage or malfunction.
- Do not use the product in the presence of a magnetic field. Malfunction can result.
- Do not let foreign matter, such as wire debris, get inside the product. Otherwise it can cause damage or malfunction.
- Do not use the product in an environment that is exposed to temperature cycle. Heat cycles other than ordinary changes in temperature can adversely affect the internal components of the product.
- Do not expose the product to direct sunlight. If using in a location directly exposed to sunlight, protect the product from the sunlight. Failure or malfunction may occur.
- Keep within the specified ambient temperature range. The ambient temperature range is 0 to 50 °C. Operation under low temperature may lead to damage or operation failure due to frozen moisture in the fluid or air. Protection against freezing is necessary. Mounting of an air dryer is recommended for elimination of drainage and water. Avoid abrupt temperature changes even within the specified temperature range.
- Do not operate close to a heat source, or in a location exposed to radiant heat. Insufficient air quality may cause operation failure.

#### \*Adjustment and Operation

- Connect the load before turning the power supply on.
- Do not short-circuit the load.  
Although error is displayed when the product load has a short circuit, generated over current may lead to the damage of the product.
- Do not press the setting buttons with a sharp pointed object.  
This may damage the setting buttons.
- Supply power under no flow conditions.
- If using the product to detect very small flow differences, warm up the product for 10 to 15 minutes first.  
There will be a drift on the display/ analogue output of approx 2 to 3% for 10 minutes after the power supply is turned on.
- The product doesn't produce and output signal for 3 seconds after the power is supplied.
- Perform settings suitable for the operating conditions.  
Incorrect setting can cause operation failure.
- During the initial setting and flow setting, the product will switch the measurement output with the condition before setting.  
Check the effect to the equipment before setting.  
Stop the control system for setting, if necessary.
- Do not touch the LCD during operation.  
The display can vary due to static electricity.

#### \*Maintenance

- Perform regular maintenance and inspections.  
There is a risk of unexpected failure of components due to the malfunction of equipment and machinery.
- Before performing maintenance, turn off the power supply, stop the air supply, exhaust the residual compressed air in the piping, and verify the release of air.  
Otherwise, unintended malfunction of system components can result.
- Remove the condensate periodically.  
If condensate enters the secondary side, it can cause operating failure of pneumatic equipment.
- Do not use solvents such as benzene, thinner etc. to clean the product.  
This may damage the surface of the body or erase the markings on the body.  
Use a soft cloth to remove stains.  
For heavy stains, use a damp cloth that has been soaked with diluted neutral detergent and fully squeezed, then wipe up the stains again with a dry cloth.

# Model Indication and How to Order

PF3A 7 □ H - □ □ - □ □ - □ □

Type

Symbol	Type
7	Integrated display type

Rated flow range

Symbol	Content
03	30 to 3000 L/min
06	60 to 6000 L/min
12	120 to 12000 L/min

Thread type

Symbol	Content
Nil	Rc
N	NPT
F	G *1

\*1: ISO228 compliant.

Port size

Symbol	Size	Rated flow range		
		03	06	102
10	1	●	-	-
14	1 1/2	-	●	-
20	2	-	-	●

Output specification

Symbol	OUT	FUNC *2
CS	NPN	Analogue voltage *3/ External input *4
DS	NPN	Analogue current/ External input *4
ES	PNP	Analogue voltage *3/ External input *4
FS	PNP	Analogue current/ External input *4

\*2: Analogue output or external input can be selected by pressing the buttons. Analogue output is set as the default setting.

\*3: 1 to 5 V or 0 to 10 V can be selected by pressing the buttons. The default setting is 1 to 5 V.

\*4: Accumulated, peak and bottom values can be reset using the external input.

Calibration certificate

Symbol	Content
Nil	Without calibration certificate
A *8	With calibration certificate

\*8: Made to Order. Certificate in both Japanese and English.

Unit specification

Symbol	Content
Nil	Units selection function
M	SI unit only *7

\*6: Since the unit for Japan is fixed to SI due to new measurement law, this option is for overseas.

\*7: Fixed unit instantaneous flow: L/min, Accumulated: L

Options

Nil	With lead wire with M12 connector (3 m) *5
N	No lead wire

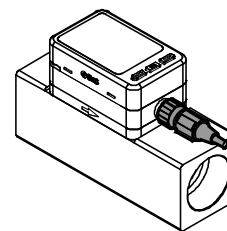

\*5: Each accessory is not assembled with the product, but shipped together.

## Accessories/ Part numbers

If an accessory is required, order using the following part number.

Product number	Description	Note
ZS-37-A	Lead wire with M12 connector	Length: 3 m

# Names and Functions of Individual Parts

## Body

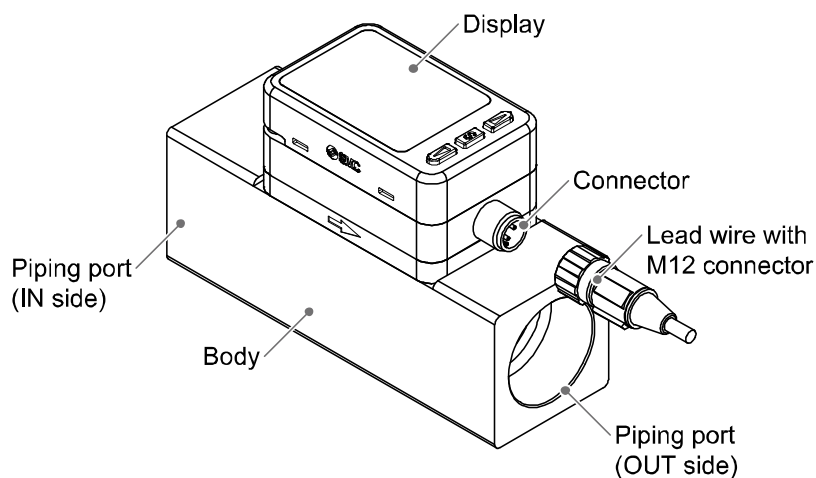

Connector pin numbers (on the product)

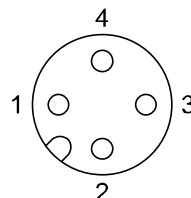

1	DC(+)
2	FUNC
3	DC(-)
4	OUT

Element	Description
Display	See below
Connector	M12 4-pin connector for electrical connections.
Lead wire with M12 connector	Lead wire for power supply and outputs.
Piping port	For piping connections. Connected to the fluid inlet at IN and to the fluid outlet at OUT.
Body	The body of the product.

## Display

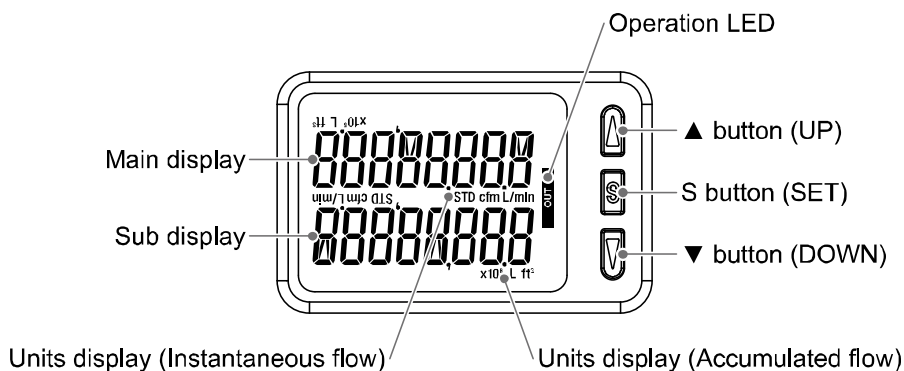

Element	Description
Main display	Displays the instantaneous flow value and error codes. (2 colour display)
Operation LED	Indicates the output status of OUT. When the output is ON: Orange LED is ON. When the accumulated pulse output mode is selected, the output display will turn off.
Sub display	Displays the accumulated flow, set value, and peak/ bottom value when in measurement mode.
▲ button (UP)	Selects the mode and the display shown on the Sub display, or increases the switch point.
S button (SET)	Press this button to change the mode and to set a value.
▼ button (DOWN)	Selects the mode and the display shown on the Sub display, or decreases the switch point.
Units display (Instantaneous flow)	Indicates the flow measurement units currently selected.
Units display (Accumulated flow)	Indicates the flow measurement units currently selected.

## ■ Definition and terminology

	Term	Definition
A	Accumulated flow	The total amount of fluid that has passed through the device. If an instantaneous flow of 100 L/min lasts for 5 minutes, the accumulated flow will be $5 \times 100 = 500$ L.
	Accumulated flow external reset	A function to reset the accumulated value to "0" when an external input signal is applied.
	Accumulated pulse output	A type of output where a pulse is generated every time a predefined accumulated flow passes. It is possible to calculate the total accumulated flow by counting the pulses.
	Accumulated-value hold time	A function to store the cumulative flow value in the product's internal memory at certain time intervals. Reads the memory data when power is supplied. Accumulation of data begins with the value read at the moment power is supplied. The time interval for memorizing can be selected from 2 or 5 minutes.
	Analogue output	Outputs a value proportional to the flow rate. When the analogue output is in the range 1 to 5 V, it will vary between 1 to 5 V according to the rate of flow. The same for analogue output of 0 to 10 V or 4 to 20 mA.
D	Display range	Displayable range of flow.
F	F.S. (full span/ full scale)	This means "full span" or "full scale", and indicates varied analogue output range at rated value. For example, when analogue output is 1 to 5 V, $F.S. = 5 [V] - 1 [V] = 4 [V]$ . (Reference: $1\%F.S. = 4 [V] \times 1\% = 0.04 [V]$ )
H	Hysteresis	The difference between ON and OFF points used to prevent chattering. Hysteresis can be effective in avoiding the effects of pulsation.
	Hysteresis mode	Mode where the switch output will turn ON when the flow is greater than the set value, and will turn OFF when the flow falls below the set value by the amount of hysteresis or more.
I	Instantaneous flow	The flow passing per unit of time. If it is 10 L/min, there is a flow of 10 L passing through the device in 1 minute.
	Internal voltage drop	The voltage drop across the product (and therefore not applied to the load), when the switch output is ON. The voltage drop will vary with load current, and ideally should be 0 V.
K	Key-lock function	Function that prevents changes to the settings of the flow switch (disables button operation).
N	Normal condition	The flow which is converted into the volume at 0 °C and 101.3 kPa (absolute pressure). <nor> indicates that the product is in normal condition.
O	Operating pressure range	The pressure range in which the product can be used.
	Operating temperature range	Ambient temperature range in which the product can operate.
	Operating humidity range	Humidity range in which the product can operate.
	Operating fluid temperature	Range of fluid temperature that can be measured by the product.

	Terminology	Definition
P	Pressure characteristics	Indicates the change in the display value and analogue output when the fluid pressure changes.
	Proof pressure	Pressure limit that if exceeded will result in mechanical and/or electrical damage to the product.
R	Rated flow range	The flow range within which the product will meet all published specifications.
	Repeatability	Reproducibility of the display or analogue output value, when the measured quantity is repeatedly increased and decreased.
	Response time (Analogue output)	The time from when the flow is applied as a step input (when the flow rate changes from 0% to 100% instantaneously) until the analogue output (voltage or current) reaches 90% of the rated flow rate.
	Response time (Switch output)	The time from when the flow is applied as a step input (when the flow rate changes from 0% to 100% instantaneously) until the switch output, turns ON (OFF) at 90% of the rated flow rate.
S	Set point range	Range in which ON-OFF point (threshold) is adjustable
	Smallest settable increment	The resolution of set and display values. If the minimum setting unit is 2 L/min, the display will change in 2 L/min steps, e.g. 30.....32.....34 L/min.
	Standard condition	The flow which is converted to the volume at 20 °C and 101.3 kPa (absolute pressure). <Std> indicates that the product is standard condition.
	Switch output	Output type that has only 2 conditions, ON or OFF. In the ON condition an indicator LED will show, and any connected load will be powered. In the OFF condition, there will be no indicator LED and no power supplied to the load. An output showing such behavior is called switch output.
T	Temperature characteristics	Indicates the change in the display value and analogue output caused by ambient temperature changes.
U	Units selection function	A function to select display units other than the international unit (SI unit) specified in the new Japanese measurement law. The product is not equipped with this function.
W	Wetted part	A part that comes into physical contact with the fluid.
	Window comparator mode	An operating mode in which the switch output is turned on and off depending on whether the flow is inside or outside the range of two set values

## Mounting and Installation

### Mounting

- Never mount the product in a place that will be used as a mechanical during piping.
  - Attach the piping so that the fluid flows in the direction indicated by the arrow on the body.
  - Never mount the product upside down.
  - The monitor with integrated display can be rotated.
- Rotating the display with excessive force will damage the end stop.

#### ○Flow direction

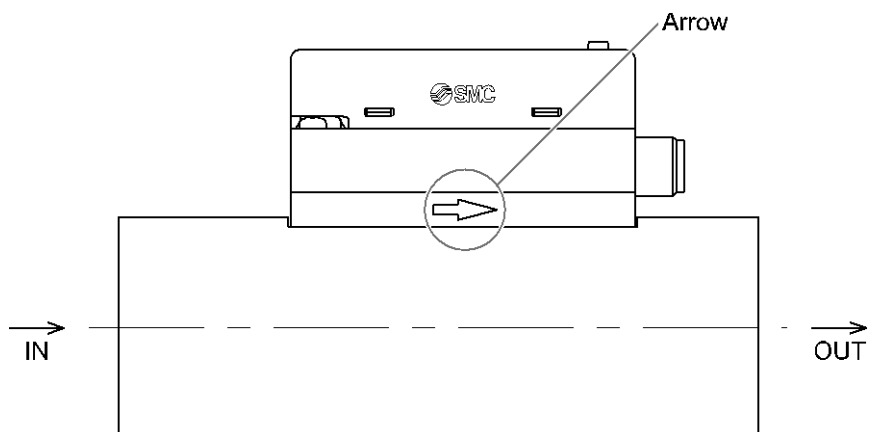

#### ○Rotation of the display

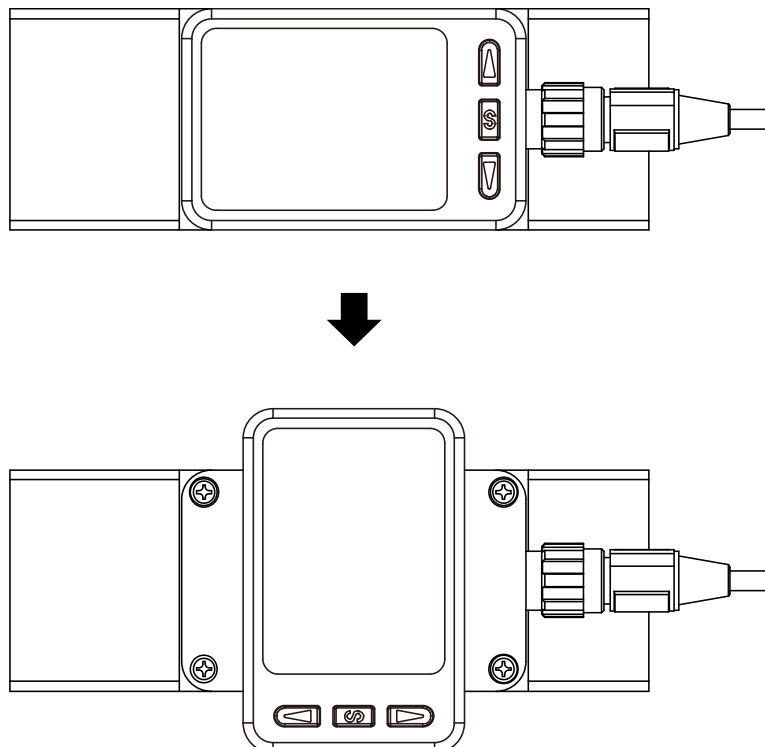

## ■ Installation

### Direct mounting

- Install the product with 4 screws suitable for the product number according to the required tightening torque.

Product number	Suitable screws	Tightening torque	Thread depth
PF3A703H	Equivalent to M4	1.5 Nm±10%	7
PF3A706H	Equivalent to M5	3 Nm±10%	8
PF3A712H	Equivalent to M6	5.2 Nm±10%	9

- Prepared by the user.
- Refer to the dimension drawing (page 75) for the diameter and depth of the mounting screw holes.

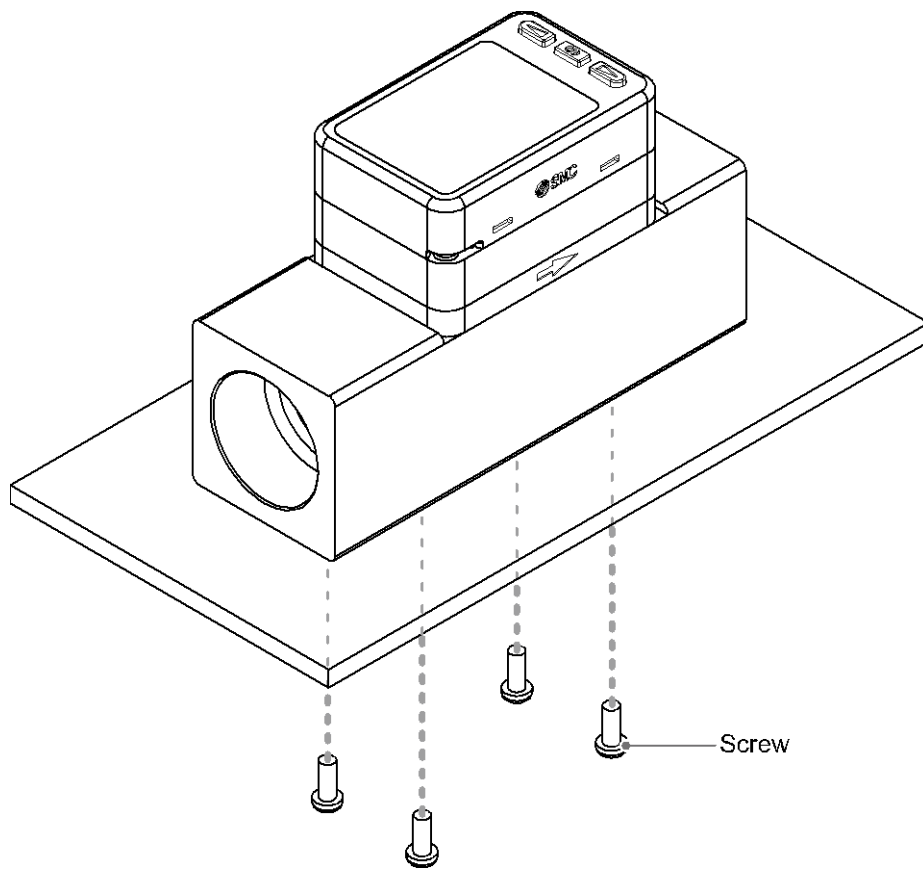



## ■Piping

- Do not connect equipment or piping which may generate a fluctuation in flow or drift at the IN side of the product.  
When installing a regulator at the IN side of the product, make sure that hunting is not generated.
- The piping on the IN side must have a straight section of piping whose length is 8 times the piping diameter or more.  
If a straight section of piping is not installed, the accuracy will vary by approximately 3%F.S.  
Refer to the graph for IN side straight pipe length and accuracy (page 74).
- Avoid sudden changes to the piping size on the IN side of the product.  
The accuracy may vary.
- Do not release the OUT side piping port of the product directly to the atmosphere without connecting piping.  
The accuracy may vary.

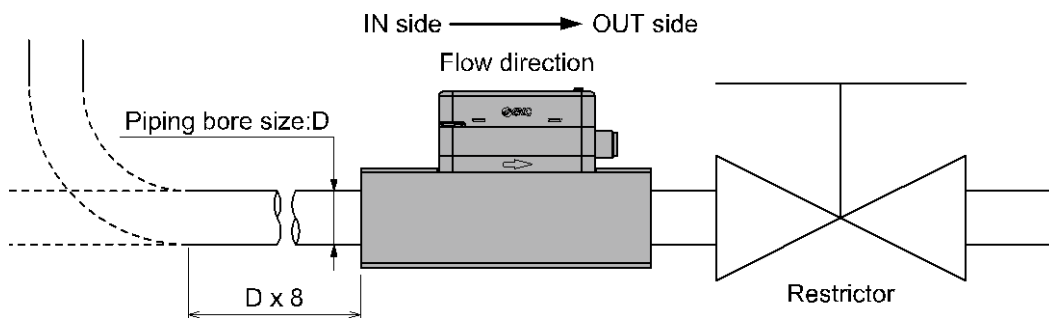

- Use the correct tightening torque for piping. (Refer to the table below for the required torque values.)
- If the tightening torque is exceeded, the product can be damaged.  
If the tightening torque is insufficient, the fittings may become loose.
- Avoid any sealing tape getting inside the fluid passage.
- Ensure there is no leakage after piping.
- When mounting the fitting, a spanner should be used on the body (metal part) of the fitting only.  
Holding other parts of the product with a spanner may damage the product.  
Specifically, make sure that the spanner does not damage the M12 connector.

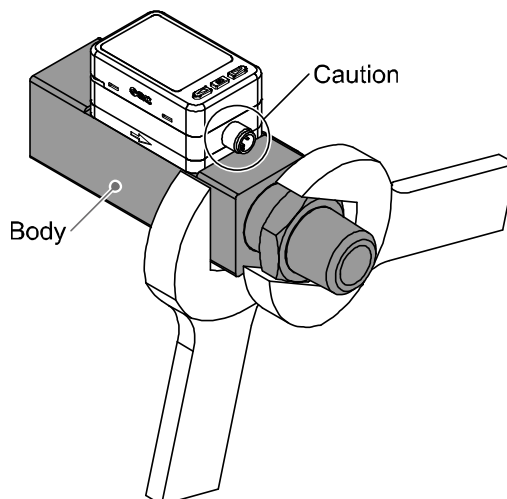

Nominal thread size	Required torque
Rc1, NPT1	36 to 38 Nm
Rc1 1/2, NPT1 1/2, Rc2, NPT2	48 to 50 Nm

Port size	Width across flats of attachment
1	45 mm
1 1/2	60 mm
2	70 mm

## ■Wiring

### Connection

- Connections should only be made with the power supply turned off.
- Use a separate route for the product wiring and any power or high voltage wiring. If wires and cables are routed together with power or high voltage cables, malfunction may result due to noise.
- If a commercially available switching power supply is used, be sure to ground the frame ground (FG) terminal. If the product is connected to the commercially available switching power supply, switching noise will be superimposed and the product specifications will not be satisfied. In that case, insert a noise filter such as a line noise filter/ ferrite between the switching power supplies or change the switching power supply to the series power supply.

### Connecting/ Disconnecting

- Align the lead wire connector with the connector key groove, and insert it straight in. Turn the knurled part clockwise. Connection is complete when the knurled part is fully tightened. Check that the connection is not loose.
- To remove the connector, loosen the knurled part and pull the connector straight out.

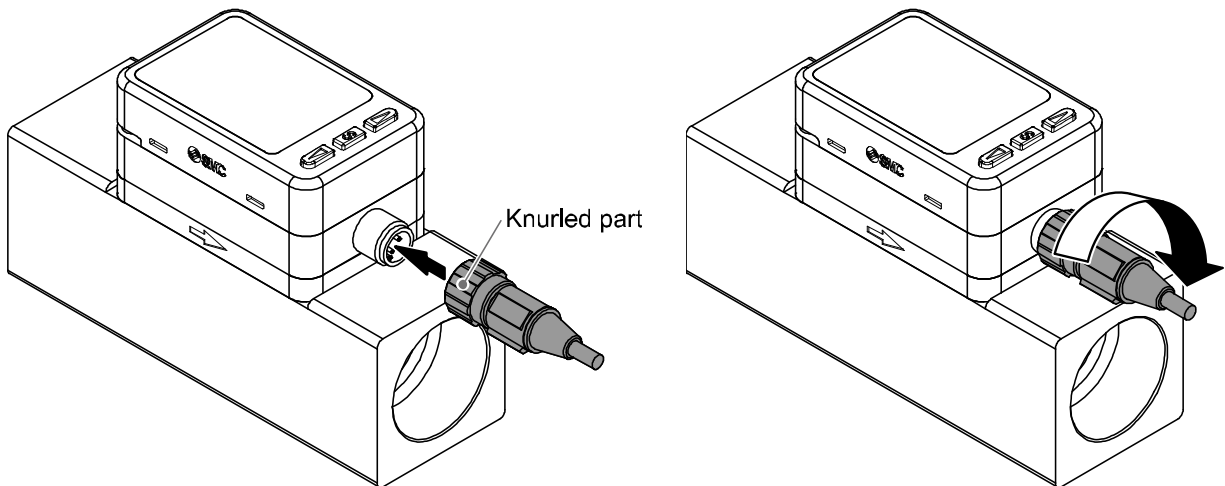

### Connector pin numbers (lead wire)

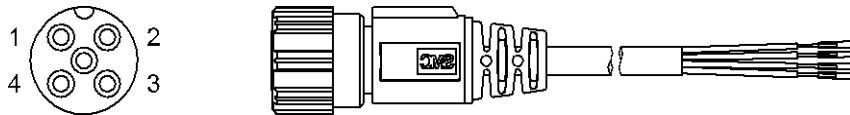

Pin number	Wire colour	Description
1	Brown	DC(+)
2	White	FUNC
3	Blue	DC (-)
4	Black	OUT

## Internal circuit and wiring examples

### NPN + Analogue output type

PF3A7□□H-□□-CS/DS□-□□

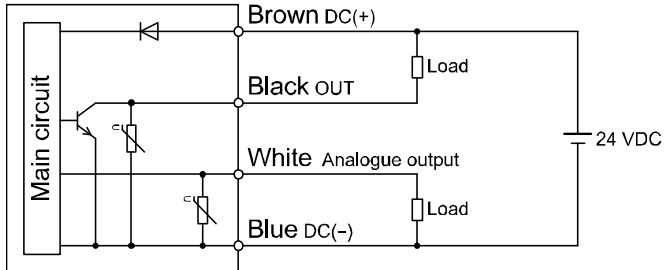

Maximum applied voltage: 28 VDC

Maximum load current: 80 mA

Internal voltage drop 1 V max.

CS: Analogue output: Select 1 to 5 V or 0 to 10 V.

Output impedance: 1 k

DS: Analogue output 4 to 20 mA

Max. load impedance 600  $\Omega$

Min. load impedance: 50  $\Omega$

### NPN (1 output) + External input type

PF3A7□□H-□□-CS/DS□-□□

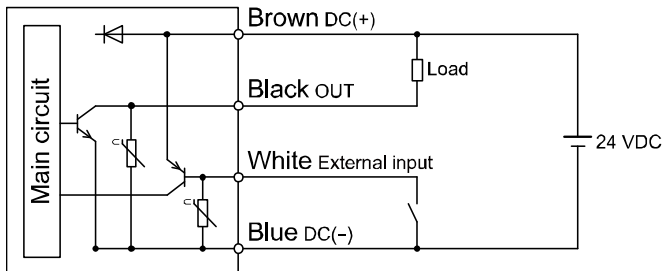

Maximum applied voltage: 28 VDC

Maximum load current: 80 mA

Internal voltage drop 1 V max.

External input: Input voltage of 0.4 V max. (reed or solid state input) for 30 ms or longer

**NPN + Analogue output type**

PF3A7□□H-□□-ES/FS□-□□

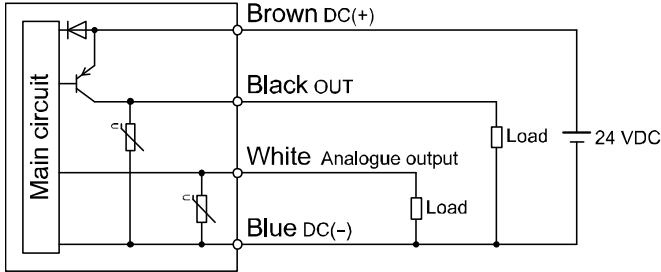

Maximum load current: 80 mA

Internal voltage drop 2 V max.

ES: Analogue output: Select 1 to 5 V or 0 to 10 V

Output impedance: 1 k

FS: Analogue output 4 to 20 mA

Max. load impedance: 600 Ω

Min. load impedance: 50 Ω

**PNP (1 output) + External input type**

PF3A7□□H-□□-ES/FS□-□□

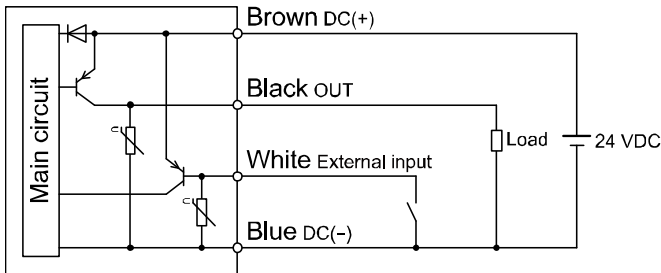

Maximum load current: 80 mA

Internal voltage drop 2 V max.

External input: Input voltage of 0.4 V max. (reed or solid state input) for 30 ms or longer

**Example of wiring for accumulated pulse output**

PF3A7□□H-□□-CS/DS□-□□

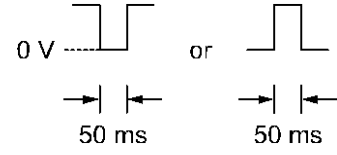
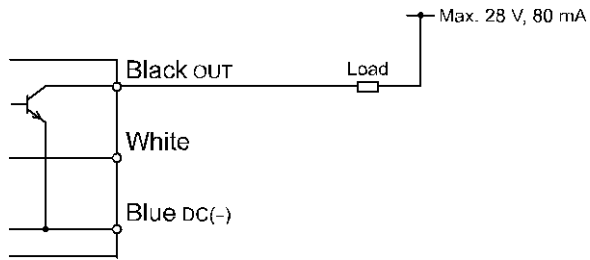

PF3A7□□H-□□-ES/FS□-□□

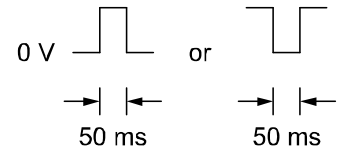
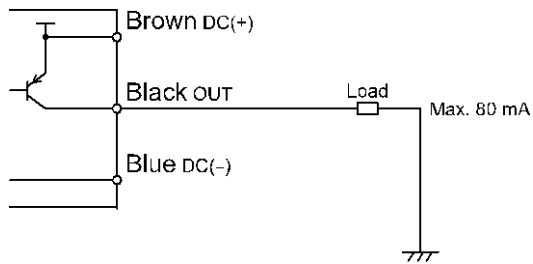

# Outline of Settings [Measurement mode]

Power is supplied.



The output will not operate for 3 seconds after supplying power.  
The identification code of the product is displayed.



## [Measurement mode]

Measurement mode is the condition where the flow is detected and displayed, and the switch function is operating.  
This is the basic mode; other modes should be selected for set-point changes and other function settings.

### Measurement mode screen

Current flow rate  
(Main display)

Set value or peak/bottom value  
(Sub display)

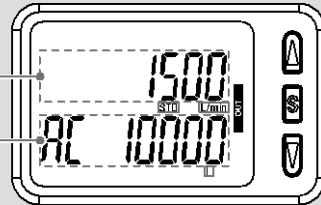

### Sub display

In measurement mode, the display of the sub display can be temporarily changed by pressing the ▲ or ▼ buttons.



\*: Arbitrary display mode can be added to the sub display by setting the [F10] sub display.

(The default setting does not include arbitrary display.)

\*: The example shown is for the 3000 L/min type.

Press S button once.

Press the S button for 1 to 3 seconds.

Press the S button for 3 to 5 seconds.



**Change of Set Value**  
(3 step setting mode)  
(Refer to page 22)

**Change of Set Flow and Hysteresis**  
(Simple setting mode)  
(Refer to page 25)

**Change the Function Settings**  
(Function selection mode)  
(Refer to page 27)

**Other Settings**  
(Refer to page 60)

\*: The outputs will continue to operate during setting.

\*: If a button operation is not performed for 30 seconds during the setting, the display will flash. (This is to prevent the setting from remaining incomplete if, for instance, an operator were to leave during setting.)

\*: 3 step setting mode, simple setting mode and function selection mode settings will reflect on each other.

## Change of Set Value [3 step setting mode]

### 3 step setting mode

In the 3 step setting mode, the set value selected in the sub display and the hysteresis can be changed in just 3 steps.

Use this mode if the product is to be used straight away, after changing only the set values.

The current flow value is displayed on the main display

### ■ Default setting

When the flow exceeds the set value [P], the switch will be turned ON.

When the flow falls below the set value by the amount of hysteresis [H] or more, the switch will turn OFF.

If the operation shown below is acceptable, then keep these settings.

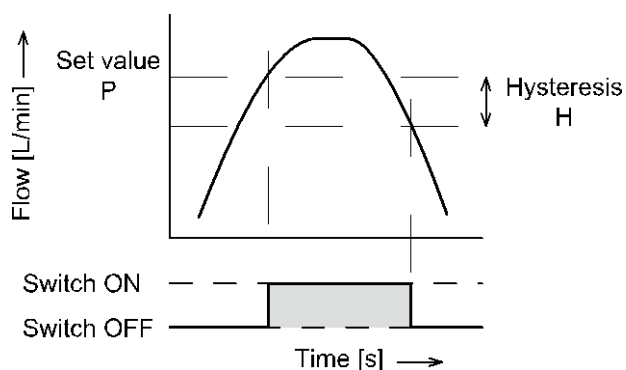

#### ● PF3A703H

Item	Default Settings
[P] Set value of OUT	1500 L/min
[H] Hysteresis of OUT	150 L/min

#### ● PF3A706H

Item	Default Settings
[P] Set value of OUT	3000 L/min
[H] Hysteresis of OUT	300 L/min

#### ● PF3A712H

Item	Default Settings
[P] Set value of OUT	6000 L/min
[H] Hysteresis of OUT	600 L/min

\*: For hysteresis, please refer to [F 1] Setting of OUT (page 31).

<Operation>

[Hysteresis mode]

In the 3 step setting mode, the set value (P or n) and hysteresis (H) can be changed.

Set the items on the sub display (set value and hysteresis) using the ▲ or ▼ buttons.

When changing the set value, follow the operation below. The hysteresis setting can be changed in the same way.

- (1) Press the S button once when the item to be changed is displayed on the sub display.  
The set value on the sub display (right) will start flashing.

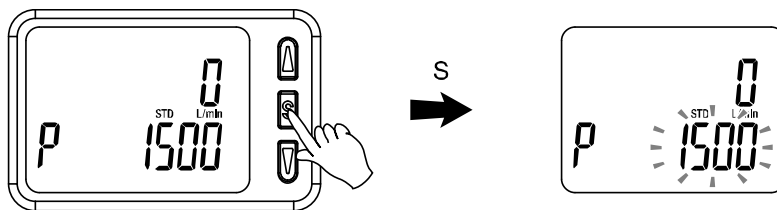

- (2) Press the ▲ or ▼ button to change the set value.  
The ▲ button is to increase and the ▼ button is to decrease the set value.

- Press the ▲ button once to increase the value by one digit, press and hold to continuously increase.

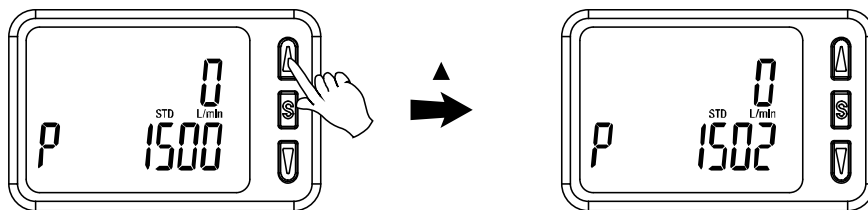

- Press the ▼ button once to reduce the value by one digit, press and hold to continuously reduce.

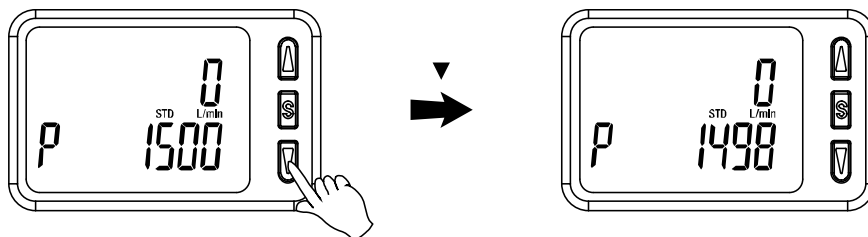

- When ▲ and ▼ buttons are pressed simultaneously for 1 second or more, the set value is displayed as [ - - - ], and the set value will be set to the same as the displayed value automatically (snap shot function) (Refer to page 60). Afterwards, it is possible to adjust the value by pressing ▲ or ▼.

- (3) Press the S button to complete the setting.



[Window comparator mode]

The Flow switch turns on within a set flow range (from PL to PH). Set PL, the lower limit of the switch operation, and PH, the upper limit of the switch operation and WH (hysteresis) following the instructions given above.

When reversed output is selected, the main screen displays [nL] and [nH].

[Accumulated output mode]

Set each P (set value), referring to setting method of page 23.

(When reversed output is selected, the main screen displays [n]).

Refer to the switch output modes list for the relationship between the set values and operation (page 31).

\*: Setting of the normal/ reverse output switching and hysteresis/window comparator mode switching are performed using the function selection mode [F 1] OUT setting.

## Change of Set Flow and Hysteresis [Simple setting mode]

### ■ Simple setting mode

In the simple setting mode, the set value, hysteresis and delay time can be changed while checking the current flow value (main display).

<Operation>

[Hysteresis mode]

- (1) Press the S button for 1 second or longer (but less than 3 seconds) in measurement mode. [SEt] is displayed on the main display.

When the button is released while in the [SEt] display, the current flow value is displayed on the main display, [P] or [n] is displayed on the sub display (left) and the set value is displayed on the sub display (right).

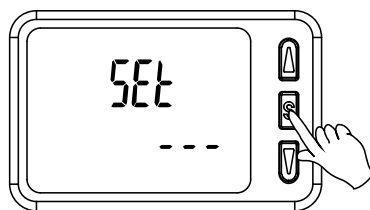

- (2) Change the set value using the ▲ or ▼ button, and press the SET button to set the value. Then, the setting moves to hysteresis setting.

(The snap shot function can be used. (Refer to page 60))

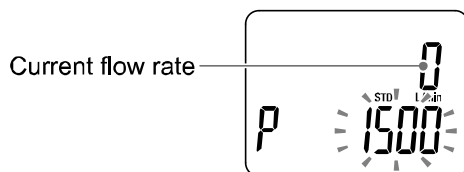

- (3) Change the set value using the ▲ or ▼ button, and press the S button to set the value.

(The snap shot function can be used. (Refer to page 60))

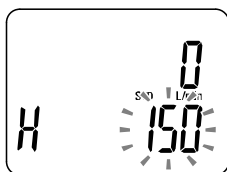

- (4) Press and hold the S button for 2 seconds or longer to complete the OUT setting.  
(If the button is pressed for less than 2 seconds, the setting will be returned to P.)

\*1: Selected items of (1) to (3) become valid after pressing the S button.

\*2: After enabling the setting by pressing the S button, it is possible to return to measurement mode by pressing the S button for 2 seconds or longer.

\*3: When the output mode is set to error output or output OFF (refer to page 33), the simple setting mode cannot be used.  
(the setting returns to measurement mode by releasing the button when [SEt] is displayed).

[Window comparator mode]

Set PL, the lower limit of the switch operation, and PH, the upper limit of the switch operation, and WH (hysteresis) following the instructions given above. (refer to setting method on page 25)  
(When reversed output is selected, the main screen displays nL and nH.)

[Accumulated output mode]

Set each P (set value), referring to the Setting method on page 25.  
(When reversed output is selected, the main screen displays n.)

Refer to the switch output modes list for the relationship between the set values and operation (page 31).

## Change the Function Settings [Function selection mode]

### ■ Function selection mode

In this mode, each function setting can be changed separately.

**In measurement mode, press the S button for 3 seconds or longer to display [F 0].**

Press the ▲ or ▼ button to select the function to be changed.

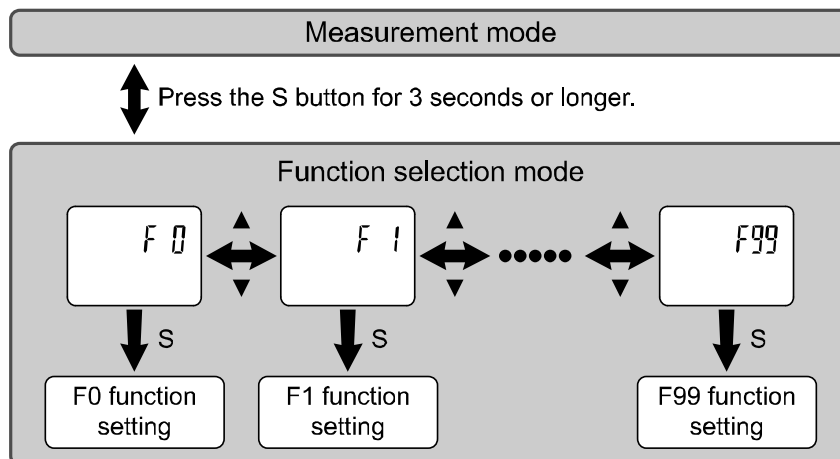

**Press the S button for 2 seconds or longer to return to measurement mode.**

## ■ Default setting

Function (Main display)		Default Settings (Right sub display)	Applicable Page
(Main display)	(Left sub display)		
[F 0]	[ rEF] Select display units	[ Std] Standard condition	Page 29
	[ Uni] Units selection function *1	[ L] L/min	
[F 1]	[ oUt] Select output mode	[ HyS] Hysteresis mode	Page 31
	[ ot] Select switch mode	[ P] Normal output	
	[ P] Select input switch operation	[ 1500] 1500 L/min (PF3A703H)	
		[ 3000] 3000 L/min (PF3A706H)	
		[ 6000] 6000 L/min (PF3A712H)	
	[ H] Setting of Hysteresis	[ 150] 150 L/min (PF3A703H)	
		[ 300] 300 L/min (PF3A706H)	
[ 600] 600 L/min (PF3A712H)			
[ CoL] Select display colour	[ SoG] Green when ON Red when OFF		
[F 3]	[ FiL] Response time	[ 1.0] 1 second	Page 40
[F 5]	[ FnC] Select FUNC (switching Analogue output *2/ External input)	[ oUt] Analogue output	Page 41
[F10]	[ Sub] Select sub display (Line name setting *3)	[ dEF] Default setting	Page 44
[F13]	[ rEv] Select Reverse display	[ oFF] Reverse display OFF	Page 45
[F14]	[ Cut] Select Zero cut-off setting	[ 1.0] 1%F.S. cut	Page 46
[F30]	[ SAv] Accumulated value hold	[ oFF] Not stored	Page 50
[F80]	[ dSP] Display OFF mode	[ on] Display ON	Page 51
[F81]	[ Pin] Security code	[ oFF] Not used	Page 52
[F90]	[ ALL] Setting of all functions	[ oFF] Not used	Page 54
[F96]	[ Sin] Check of input signal	[ - - -] No input signal	Page 56
[F98]	[ tES] Setting of output check	[ n] Normal output	Page 57
[F99]	[ ini] Reset to the default settings	[ oFF] Not used	Page 59

\*1: Setting is only possible for models with the units selection function.

\*2: 1 to 5 V or 0 to 10 V can be selected when the analogue voltage output type is used.

Analogue output free range function can be selected.

\*3: When Line name is selected, a suitable line name can be input.

## ■ [F 0] Reference condition/ Units selection function

### Reference condition

Standard condition or normal condition can be selected.

Standard condition and normal condition are defined as follows:

- Standard condition: Displayed flow rate which is converted to volume at 20°C, 101.3 kPa (absolute pressure).
- Normal condition: Displayed flow rate which is converted to volume at 0°C, 101.3 kPa (absolute pressure).

### Units selection function

With the units selection function, the selectable display units are L/min or CFM (ft<sup>3</sup>/min).

This setting is only available for models with the units selection function.

\*: This function is not displayed for models without unit selection function.

<Operation>

Display [F\_0] by pressing ▲ or ▼ button in function selection mode.

Press the S button. ↓ Move on to the reference condition.

### Reference condition

Press the ▲ or ▼ button to select the reference condition.

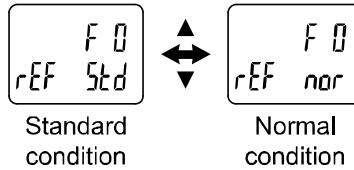

Press the S button to set.  
(When fixed to SI units)  
Return to function selection mode.

Press the S button to set.  
(When the products with a units  
selection function is used)

### Units selection function

Press the ▲ or ▼ button to select the display unit.

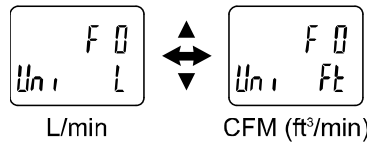
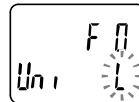

Press the S button to set. ↓ Return to function selection mode.

[F 0] Reference condition/ Units selection function completed.

Flow specification when [ Ft ] is selected by the units selection function

Models			PF3A703H	PF3A706H	PF3A712H
Flow rate	Rated flow range		1.1 to 105.9 cfm	2.2 to 211.9 cfm	4.5 to 423.8 cfm
	Setting flow range	Instantaneous flow	1.1 to 111.2 cfm	2.2 to 222.6 cfm	4.5 to 445.0 cfm
		Accumulated flow	0 to 999,999,999,990 ft <sup>3</sup>		
	Setting min. unit	Instantaneous flow	0.1 cfm	0.2 cfm	0.5 cfm
		Accumulated flow	1 ft <sup>3</sup>	10 ft <sup>3</sup>	
Accumulated pulse conversion		1, 10 ft <sup>3</sup>		10, 100 ft <sup>3</sup>	
Display	Display controllable range	Instantaneous flow	0 to 111.2 cfm	0 to 222.6 cfm	0 to 445.0 cfm
		Accumulated flow	0 to 999,999,999,990 ft <sup>3</sup>		
	Display min. unit	Instantaneous flow	0.1 cfm	0.2 cfm	0.5 cfm
		Accumulated flow	1 ft <sup>3</sup>	10 ft <sup>3</sup>	

\*: Flow rate in the specification is the value at standard condition.

## ■[F 1] Setting of OUT

Set the output mode of OUT.

### ●Switch output modes

Select the output mode required from the table below.

	Normal output	Reversed output
Hysteresis mode		
Window comparator mode		
Accumulated output mode (Increment)	<ul style="list-style-type: none"> <li>Count up from "0".</li> <li>Turn ON when the set value is reached.</li> <li>Return to "0" by reset.</li> </ul>	<ul style="list-style-type: none"> <li>Count up from "0".</li> <li>Turn OFF when the set value is reached.</li> <li>Return to "0" by reset.</li> </ul>
Accumulated output mode (Decrement)	<ul style="list-style-type: none"> <li>Count down from set value.</li> <li>Turn ON when the "0" is reached.</li> <li>Return to set value by reset.</li> </ul>	<ul style="list-style-type: none"> <li>Count down from set value.</li> <li>Turn OFF when the "0" is reached.</li> <li>Return to set value by reset.</li> </ul>
Accumulated pulse output mode		
Output off mode		

\*: The operation may become unstable if hysteresis mode or window comparator mode are used during fluctuating flow conditions. In this case, maintain an interval between the set values and start using after confirming stable operation.



● Flow setting chart

Refer to the list of switch output modes for the setting procedure.  
Mark the procedure path with a pen or a marker.

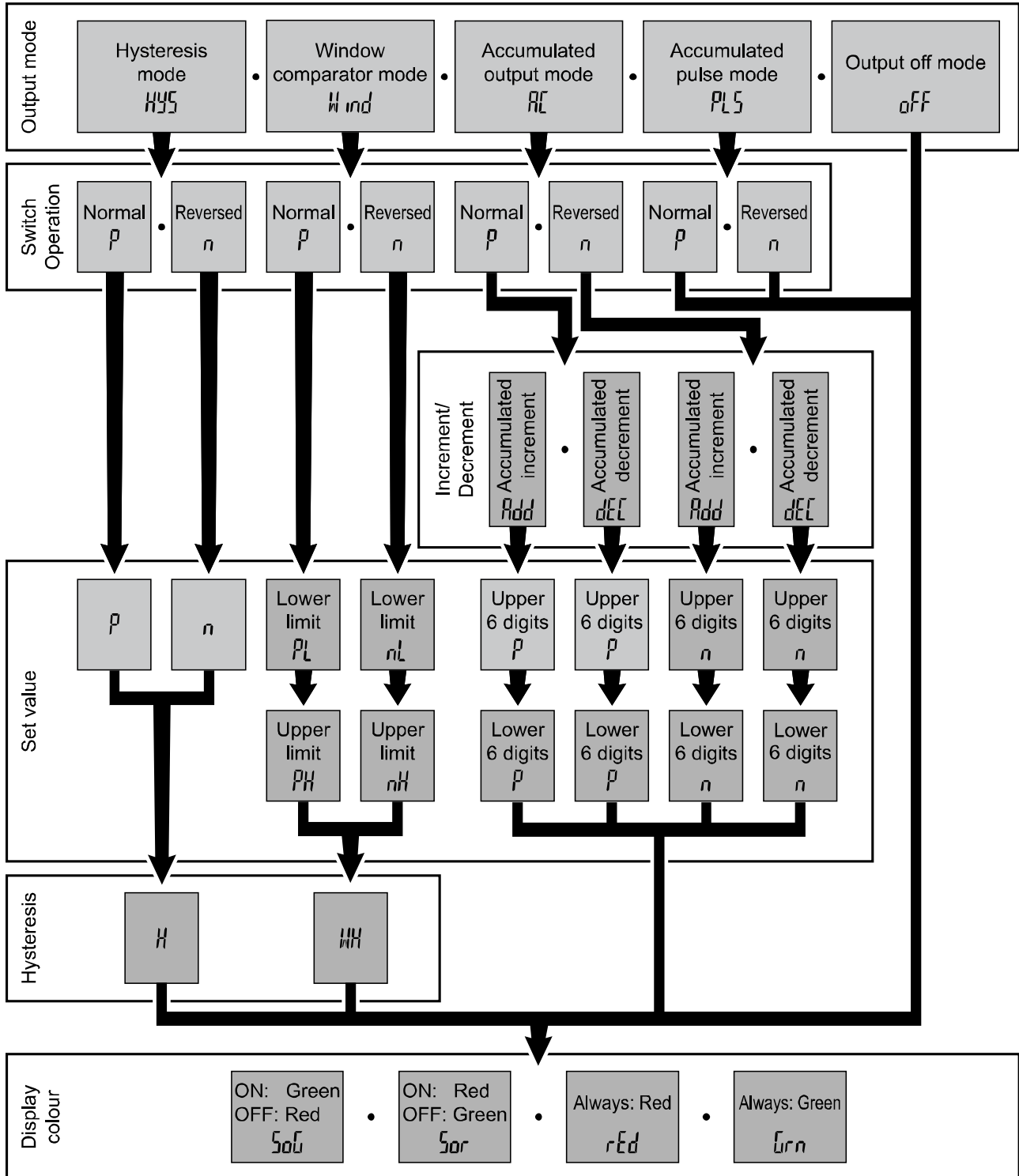

Enter the items you selected, following the procedure below.

Follow the setting flow chart.

<Operation>

Display [F\_1] by pressing ▲ or ▼ button in function selection mode.

Press the S button. ▼ Move on to select output mode.

### Select output mode

Press the ▲ or ▼ button to select the output mode.

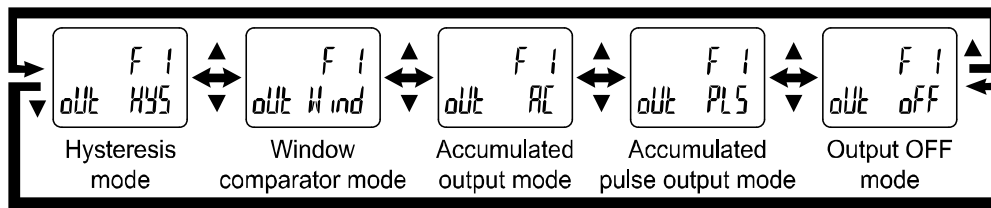

Press the S button to set. ▼ Move on to select normal output/reversed output.

### Select Normal output/ Reversed output

Press the ▲ or ▼ button to select Normal output/ Reversed output.

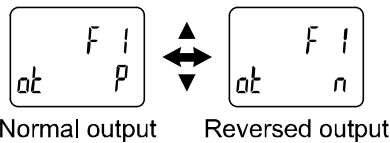
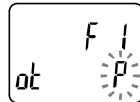

\*: By switching to reversed output, the display colour will change in relation to the setting.

Press the S button to set. ▼ Move on to settings.

Hysteresis mode is selected: Refer to page [35](#)  
Window comparator mode is selected: Refer to page [36](#)  
Accumulated output mode is selected: Refer to page [37](#)  
Accumulated pulse output mode is selected: Refer to page [39](#)

After inputting the set value, press the S button to complete the setting. ▼ Move on to select display colour.

[oFF] Output off is selected

Press the S button to move on to select display colour.

\*: When the output off mode is selected, the output operation indicator LED will turn off.

\*: oFF is displayed as the set value in the sub display of the measurement mode.



### Select display colour

Press the ▲ or ▼ button to select the display colour.

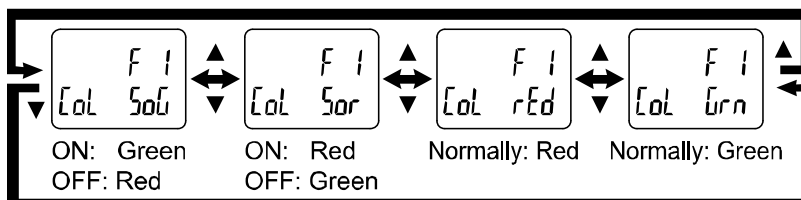
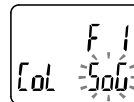

Press the S button. ↓ Return to function selection mode.

[F 1] Setting of OUT completed.

\*: Selected item becomes valid after pressing S button.

\*: After enabling the setting by pressing S button, it is possible to return to the measurement mode by keeping pressing S button.

a. When hysteresis mode is selected

**Input of set value**

Set the flow based on the setting method on page 31.  
The snap shot function can be used. (Refer to page 60)

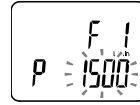

Press the S button to set. ↓ Move on to setting of hysteresis.

**Setting of Hysteresis**

Set the flow based on the setting method on page 31.  
The snap shot function can be used. (Refer to page 60)



Press the S button to set. ↓ Move on to select display colour.

Select display colour  
(Refer to select display colour of page 34.)

\*: Example for 3000 L/min type the above

\*: The set value and hysteresis settings limit each other.

b. When window comparator output mode is selected

**Input of set value (Lower limit value)**

Set the flow based on the setting method on page 31.  
The snap shot function can be used. (Refer to page 60)



Press the S button to set. ↓ Move on to input of set value (upper limit value).

**Input of set value (Upper limit value)**

Set the flow based on the setting method on page 31.  
The snap shot function can be used. (Refer to page 60)

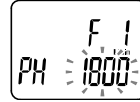

Press the S button to set. ↓ Move on to setting of hysteresis.

**Setting of Hysteresis**

Set the flow based on the setting method on page 31.

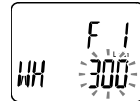

Press the S button to set. ↓ Move on to select display colour.

Select display colour  
(Refer to select display colour of page 34.)

\*: Example for 3000 L/min type the above

\*: The set value and hysteresis settings limit each other.

c. When Accumulated output mode is selected

**Select accumulated output increment (addition)/ decrement (subtraction)**

Press the ▲ or ▼ button to select the accumulated increment/ decrement.

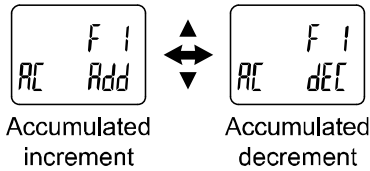
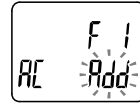

Press the S button to set. ↓ Move on to input the set value (upper 6 digits).

The accumulated output can be set between 0 and 999,999,999,990 L.  
The set value is input starting from the first 6 digits.

**Input of set value (upper 6 digits)**

All of the values will flash.



Press the ▲ or ▼ button to change the value.  
Press the S button to move to the digit to the right.

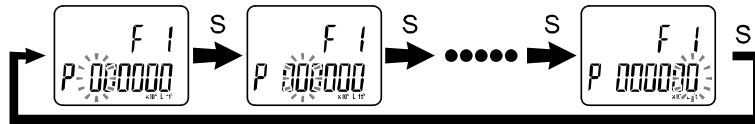

Press the S button for 1 second or longer to flash all the values.  
(Press the S button while all the digits are flashing to move on to the setting of the lower 6 digits.)

\*: As the unit for setting of upper 6 digits,  $\times 10^6$  and L flash.

Press the S button to set. ↓ Move on to input of set value (lower 6 digits).



### Input of set value (lower 6 digits)

All of the values will flash.

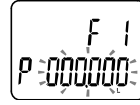

Press the ▲ or ▼ button to change the value.  
Press the S button to move on to the digit to the right.

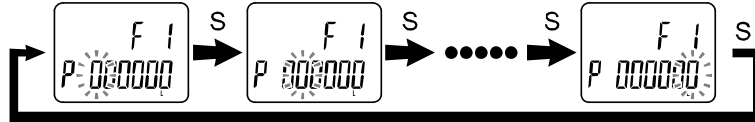

Press the S button for 1 second or longer to flash all the values.  
(Press the S button while all the digits are flashing to move to the setting of the display colour.)

\*: As the unit for setting of lower 6 digits, L flashes.

Press the S button to set. ↓ Move on to select display colour.

Select display colour  
(Refer to select display colour of page 34.)

\*: Even if the S button is pressed for 2 seconds or longer during the inputting of the set value, the mode is not changed to the measurement mode.  
It is possible to return to the measurement mode by keeping pressing S button for 2 seconds or longer while all the values are flashing.

d. When accumulated pulse output mode is selected

**Select accumulated pulse output**

Press the ▲ or ▼ button to select accumulated pulse output.

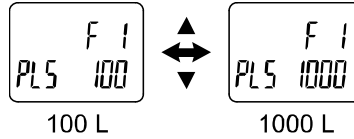

Press the S button to set. ↓ Move on to select display colour.

Select display colour  
(Refer to select display colour of page 34.)

- \*: When the accumulated pulse output mode is selected, the output operation indicator LED will turn off.
- \*: When flow rate is less than the rated flow range, the accumulated pulse output will not operate.
- \*: When the flow exceeds the maximum display range, the accumulated pulse output will be equivalent to the maximum display value.



## ■[F 3] Response time setting

The response time of the switch output and analogue output can be selected.  
Output chattering can be prevented by setting the response time.

<Operation>

Display [F\_3] by pressing ▲ or ▼ button in function selection mode.

Press the S button. ↓ Move on to select response time.

### Select response time

Press the ▲ or ▼ button to select the response time.

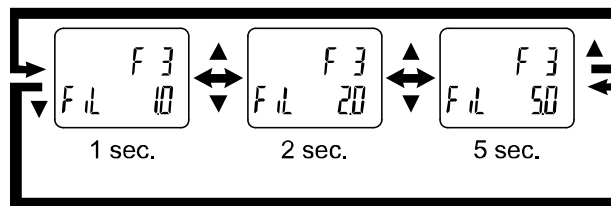

Press the S button to set. ↓ Return to function selection mode.

[F3] Response time setting complete

\*: Each set value is a guideline for 90% response time.

\*: Both the switch output and flow display are affected.

## ■[F 5] FUNC setting

Analogue output or external input can be selected.

- When analogue output is selected

1 to 5 V or 0 to 10 V can be selected when the analogue voltage output type is used.

The flow value corresponding to 5 V (10 V) or 20 mA can be selected with the analogue output free range function.

- When external input is selected

The Accumulated Flow, Peak Value and Bottom Value can be reset remotely.

- Accumulated Flow External Reset: A function to reset the Accumulated Flow value when an external input signal is applied.

In accumulated increment mode, the accumulated flow value will reset to zero, and then increase from zero.

In accumulated decrement mode, the accumulated flow value will reset to a set value, and then decrease from the set value.

\*: When the Accumulated Value is memorized, every time the Accumulated Value External Reset is activated, the memory will be accessed. Take into consideration the maximum number of times the memory can be accessed is 1.5 million times. The total of External Input times and Accumulated Value Memorizing time interval should not exceed 1.5 million times.

- Peak/ Bottom value reset: A function to clear the peak value or bottom value when an external input signal is applied.

<Operation>

Display [F\_5] by pressing ▲ or ▼ button in function selection mode.

Press the S button. ↓ Move on to select FUNC.

**Select FUNC**

Press the ▲ or ▼ button to select the FUNC setting.

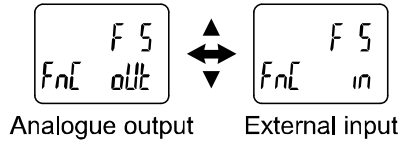

[oUt] Analogue output is selected

When the model includes the analogue voltage output type is used.

Press the S button to select analogue voltage output.

[oUt] Analogue output is selected

When the model includes the analogue current output type is used.

Press the S button to select analogue output free range function.

[in] External input is selected

Press the S button to select the external input.

**Select analogue voltage output**

Press the ▲ or ▼ button to select analogue voltage output.

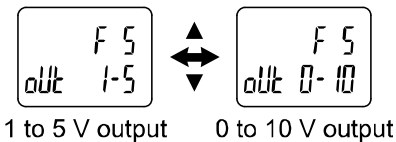

Press the S button to set.

Move on to the analogue output free range function mode.

**Select external input**

Press the ▲ or ▼ button to select external input.

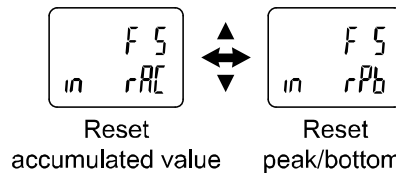

Press S button to return to function selection mode.

**Select analogue output free range function**

Press the ▲ or ▼ button to select analogue output free setting function.

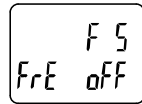

Free range function OFF

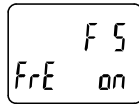

Free range function ON

[on] Free range function ON is selected

Press the S button to set value input.

[oFF] Free range function OFF is selected.

Press the S button to return to function selection mode.

**Input of set value**

Use the ▲ or ▼ buttons to set the flow value that will output 5 V (10 V) or 20 mA.



The entered flow value can be in the range: 10% of the max. rated flow, to the upper display limit.

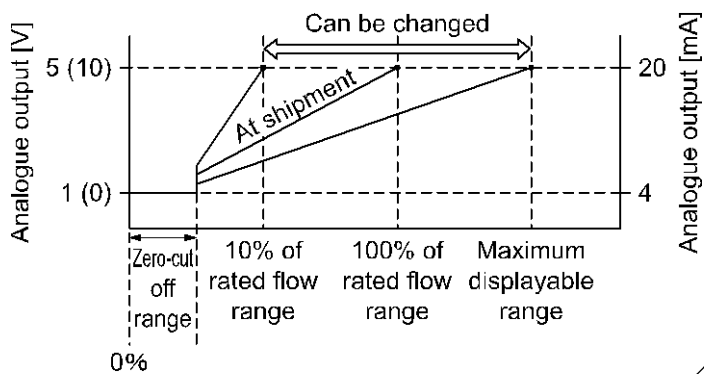

Press the S button to set. Return to function selection mode.

[F 5] FUNC setting completed

## ■[F10] Sub display setting (Line name setting)

Add the displayed item to the sub display.

- Default setting: Accumulated value, OUT setting, peak value, and bottom value are displayed.
  - Addition of line name: Line name can be added to the default display.  
A line name can be input. (up to 5 characters and/or numbers).
  - Addition of display OFF: Display off can be added to the default display.
- \*: Addition of line name and display off cannot be set at the same time.

<Operation>

Display [F10] by pressing ▲ or ▼ button in function selection mode.

Press the S button ▼ Move on to sub display setting.

### Sub display setting

Press the ▲ or ▼ button to select the display style for the sub-display.

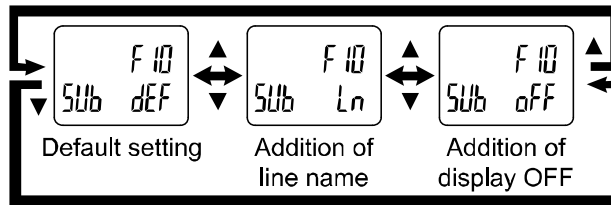

▼ [Ln] Addition of line name is added  
Press the S button to move on to input of line name.

### Input of line name

All the values flash.  
Press S button to return to function selection mode.  
Press the ▲ or ▼ button to change the characters.



The order of displayed characters is A → b → ... → Y → 0 → 1 → ... → 9 → symbol → Space.

Press the S button to move to the digit on the right.

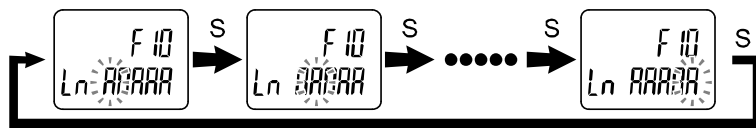

Press the S button for 1 second or longer to flash characters.

Press the S button to set. ▼ Return to function selection mode.

▼ [dEF] Default setting is selected  
[oFF] Display off is selected

Press S button to return to function selection mode.

Character for 7 segment display

Character changes as below by pressing the ▲/▼ button.

▲  
A ↔ b ↔ c ↔ d ↔ E ↔ F ↔ G ↔ H  
↔ i ↔ j ↔ k ↔ l ↔ m ↔ n ↔ o  
↔ p ↔ r ↔ s ↔ t ↔ u ↔ v  
↔ y ↔ 0 ↔ 1 ↔ 2 ↔ 3 ↔ 4 ↔ 5  
↔ 6 ↔ 7 ↔ 8 ↔ 9 ↔ . ↔ -  
↔ SPACE ↔ Return to A  
▼

For reference

[F10] Sub display setting completes.

## ■[F13] Setting for reverse display mode

This function is used to rotate display upside down.

It is used to correct the display when it is upside down due to installation of the product.

When the reverse display function is ON, the function of the ▲/▼ buttons are reversed.

<Operation>

Display [F13] by pressing ▲ or ▼ button in function selection mode.

Press the S button ↓ Move on to select reverse display.

### Select reverse display

Press the ▲ or ▼ button to select reverse display.

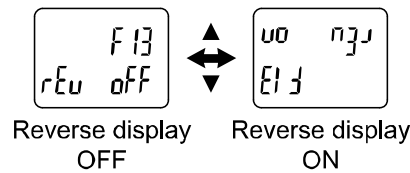
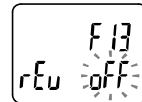

Press the S button to set. ↓ Return to function selection mode.

[F13] Setting for reverse display mode completed.

\*: When reverse display function is ON, the characters of the sub display appear upside down.

## ■[F14] Zero cut-off setting

When the flow is close to 0 L/min., the product rounds the value and zero will be displayed.

Flow value will be displayed even when the flow rate is 0 L/min. when the pressure is high or depending on the installation orientation.

Zero cut-off function makes the display zero.

The range to display zero can be changed.

< Operation >

Display [F14] by pressing ▲ or ▼ button in function selection mode.

Press the S button. ↓ Select Zero cut-off setting.

### Select zero cut-off setting

Press the ▲ or ▼ button to select the value of Zero cut-off.

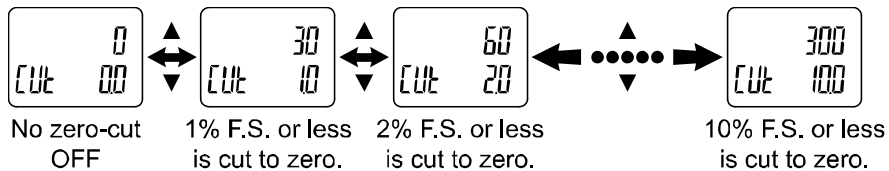

\*: The display above is an example of when [L] is selected for the PF3A703H(3000 L/min type) with the unit switching function.

\*: If the flow rate does not reach the above value, the display will be zero.

Example: PF3A703H (3000 L/min type)

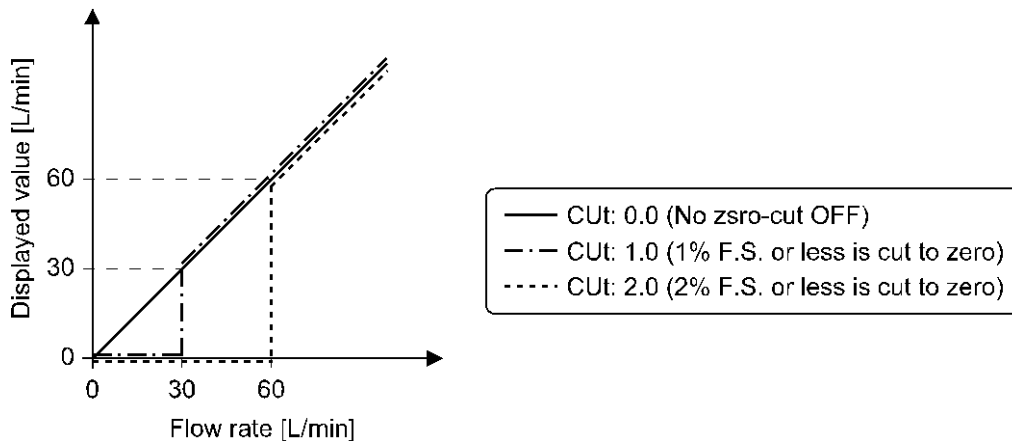

Press the S button to set. ↓ Return to function selection mode.

[F14] Zero cut-off setting completed

●Settable flow range when [L] is selected by the units selection function

Zero cut-off set value	Zero cut-off range	Displayable flow range		
		PF3A703H	PF3A706H	PF3A712H
0.0 *	0%F.S.	0 to 3150 L/min	0 to 6300 L/min	0 to 12600 L/min
1.0	0 to 1%F.S.	30 to 3150 L/min (Displays 0 when the value is below 30 L/min)	60 to 6300 L/min (Displays 0 when the value is below 60 L/min)	120 to 12600 L/min (Displays 0 when the value is below 120 L/min)
2.0	0 to 2%F.S.	60 to 3150 L/min (Displays 0 when the value is below 60 L/min)	120 to 6300 L/min (Displays 0 when the value is below 120 L/min)	240 to 12600 L/min (Displays 0 when the value is below 240 L/min)
3.0	0 to 3%F.S.	90 to 3150 L/min (Displays 0 when the value is below 90 L/min)	180 to 6300 L/min (Displays 0 when the value is below 180 L/min)	360 to 12600 L/min (Displays 0 when the value is below 360 L/min)
4.0	0 to 4%F.S.	120 to 3150 L/min (Displays 0 when the value is below 120 L/min)	240 to 6300 L/min (Displays 0 when the value is below 240 L/min)	480 to 12600 L/min (Displays 0 when the value is below 480 L/min)
5.0	0 to 5%F.S.	150 to 3150 L/min (Displays 0 when the value is below 150 L/min)	300 to 6300 L/min (Displays 0 when the value is below 300 L/min)	600 to 12600 L/min (Displays 0 when the value is below 600 L/min)
6.0	0 to 6%F.S.	180 to 3150 L/min (Displays 0 when the value is below 180 L/min)	360 to 6300 L/min (Displays 0 when the value is below 360 L/min)	720 to 12600 L/min (Displays 0 when the value is below 720 L/min)
7.0	0 to 7%F.S.	210 to 3150 L/min (Displays 0 when the value is below 210 L/min)	420 to 6300 L/min (Displays 0 when the value is below 420 L/min)	840 to 12600 L/min (Displays 0 when the value is below 840 L/min)
8.0	0 to 8%F.S.	240 to 3150 L/min (Displays 0 when the value is below 240 L/min)	480 to 6300 L/min (Displays 0 when the value is below 480 L/min)	960 to 12600 L/min (Displays 0 when the value is below 960 L/min)
9.0	0 to 9%F.S.	270 to 3150 L/min (Displays 0 when the value is below 270 L/min)	540 to 6300 L/min (Displays 0 when the value is below 540 L/min)	1080 to 12600 L/min (Displays 0 when the value is below 1080 L/min)
10.0	0 to 10%F.S.	300 to 3150 L/min (Displays 0 when the value is below 300 L/min)	600 to 6300 L/min (Displays 0 when the value is below 600 L/min)	1200 to 12600 L/min (Displays 0 when the value is below 1200 L/min)

\*: The zero-cut range of the accumulated value and accumulated pulse value should be 1% F.S. or more. However, please note that if the zero-cut set value is 0.0, any value below 1% F.S. will be cut.

\*: When setting the flow value and hysteresis within zero cut-off settable range, the on-off point varies depending on the settable range. For details, please refer to switch output (OUT) value and hysteresis are set within Zero cut-off range (page 49).



●Flow specification when [Ft] is selected by the units selection function.

Zero cut-off set value	Zero cut-off range	Set point range		
		PF3A703H	PF3A706H	PF3A712H
0.0 *	0%F.S.	0 to 111.2 cfm	0 to 222.6 cfm	0 to 445.0 cfm
1.0	0 to 1%F.S.	1.1 to 111.2 cfm (Displays 0 when the value is below 1.1 cfm)	2.2 to 222.6 cfm (Displays 0 when the value is below 2.2 cfm)	4.5 to 445.0 cfm (Displays 0 when the value is below 4.5 cfm)
2.0	0 to 2%F.S.	2.2 to 111.2 cfm (Displays 0 when the value is below 2.2 cfm)	4.4 to 222.6 cfm (Displays 0 when the value is below 4.4 cfm)	8.5 to 445.0 cfm (Displays 0 when the value is below 8.5 cfm)
3.0	0 to 3%F.S.	3.2 to 111.2 cfm (Displays 0 when the value is below 3.2 cfm)	6.4 to 222.6 cfm (Displays 0 when the value is below 6.4 cfm)	13.0 to 445.0 cfm (Displays 0 when the value is below 13.0 cfm)
4.0	0 to 4%F.S.	4.3 to 111.2 cfm (Displays 0 when the value is below 4.3 cfm)	8.6 to 222.6 cfm (Displays 0 when the value is below 8.6 cfm)	17.0 to 445.0 cfm (Displays 0 when the value is below 17.0 cfm)
5.0	0 to 5%F.S.	5.3 to 111.2 cfm (Displays 0 when the value is below 5.3 cfm)	10.6 to 222.6 cfm (Displays 0 when the value is below 10.6 cfm)	21.5 to 445.0 cfm (Displays 0 when the value is below 21.5 cfm)
6.0	0 to 6%F.S.	6.4 to 111.2 cfm (Displays 0 when the value is below 6.4 cfm)	12.8 to 222.6 cfm (Displays 0 when the value is below 12.8 cfm)	25.5 to 445.0 cfm (Displays 0 when the value is below 25.5 cfm)
7.0	0 to 7%F.S.	7.5 to 111.2 cfm (Displays 0 when the value is below 7.5 cfm)	15.0 to 222.6 cfm (Displays 0 when the value is below 15.0 cfm)	30.0 to 445.0 cfm (Displays 0 when the value is below 30.0 cfm)
8.0	0 to 8%F.S.	8.5 to 111.2 cfm (Displays 0 when the value is below 8.5 cfm)	17.0 to 222.6 cfm (Displays 0 when the value is below 17.0 cfm)	34.0 to 445.0 cfm (Displays 0 when the value is below 34.0 cfm)
9.0	0 to 9%F.S.	9.6 to 111.2 cfm (Displays 0 when the value is below 9.6 cfm)	19.2 to 222.6 cfm (Displays 0 when the value is below 19.2 cfm)	38.5 to 445.0 cfm (Displays 0 when the value is below 38.5 cfm)
10.0	0 to 10%F.S.	10.6 to 111.2 cfm (Displays 0 when the value is below 10.6 cfm)	21.2 to 222.6 cfm (Displays 0 when the value is below 21.2 cfm)	42.5 to 445.0 cfm (Displays 0 when the value is below 42.5 cfm)

\*: The zero-cut range of the accumulated value and accumulated pulse value should be 1% F.S. or more. However, please note that if the zero-cut set value is 0.0, any value below 1% F.S. will be cut.

\*: When setting the flow value and hysteresis within zero cut-off settable range, the on-off point varies depending on the settable range. For details, please refer to switch output (OUT) value and hysteresis are set within Zero cut-off range (page 49).

- When the set value and hysteresis of the switch output (OUT) is set within the zero-cut range. The operating point of the switch output will be changed, depending on the zero-cut setting value. However, please note that the set value and hysteresis of the switch output will not be changed. To maintain the on-off point, set the value and hysteresis without the zero cut-off range.

<Example: PF3A703H (3000 L/min type)>

Common setting

Output mode	Hysteresis mode
Switch operation	Normal output
Set value (P)	80
Hysteresis (H)	30

### Initial setting

Zero cut-off setting CUt: 1.0 (displays 0 for a value below 30 L/min)

Switch ON point	80 L/min or more
Switch OFF point	Below 50 L/min

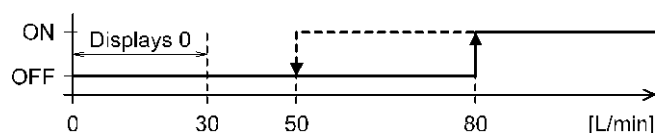

↓ Change the zero cut-off setting  
The set value (P) and hysteresis (H) cannot be changed.

### ~Condition when the operating point of hysteresis(H) is changed~

- The zero-cut setting CUt: 1.0 will be changed to CUt: 2.0. (0 will be displayed for a value below 60 L/min)

Switch ON point	80 L/min or more
Switch OFF point	Below 60 L/min (0 is displayed)

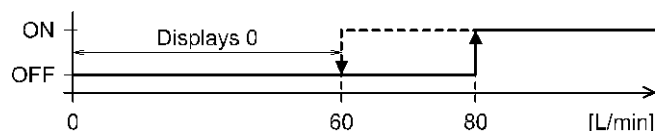

### ~Condition when the operating point of the set point (p) and hysteresis (H) is changed~

- The zero-cut setting CUt: 1.0 will be changed to CUt: 3.0. (0 will be displayed for a value below 90 L/min)

Switch ON point	90 L/min or more
Switch OFF point	Below 90 L/min (0 is displayed)

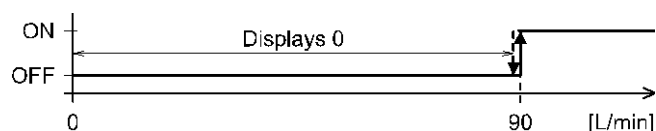

## ■[F30] Setting of accumulated value hold

In the default setting, the accumulated flow value is not held when the power supply is turned off. This function enables the accumulated flow value to be stored in permanent memory every 2 or 5 minutes.

\*: When using the accumulated value hold function, calculate the product life from the operating conditions, and use the product within its life. Maximum updating time of the accumulated value is 1.5 million times.

If the product is operated 24 hours per day, the product life will be as follows.

- Data memorized every 5 minutes: 5 minutes x 1.5 million times = 7.5 million minutes = 14.3 years
- Data memorized every 2 minutes: 2 minutes x 1.5 million times = 3 million minutes = 5.7 years

If the Accumulated Flow External Reset is repeatedly used, the product life will be shorter than calculated life.

<Operation>

Display [F30] by pressing ▲ or ▼ button in function selection mode.

Press the S button. ↓ Move on to select accumulated value hold.

### Select accumulated value hold

Press the ▲ or ▼ button to select the accumulate value hold.

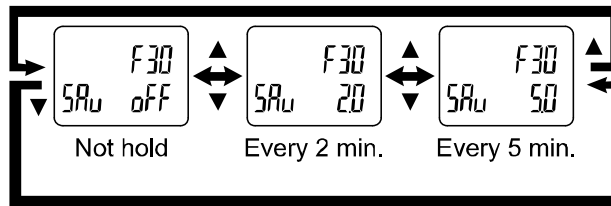

Press the S button to set. ↓ Return to function selection mode.

### [F 30] Setting of accumulated value hold complete

\*: The value is stored in memory every 2 or 5 minutes. If the power supply is turned off, the accumulated flow since the last time it was stored will be lost.

\*: When the power supply is turned on again, the accumulated flow count will start from the last value recorded at B.

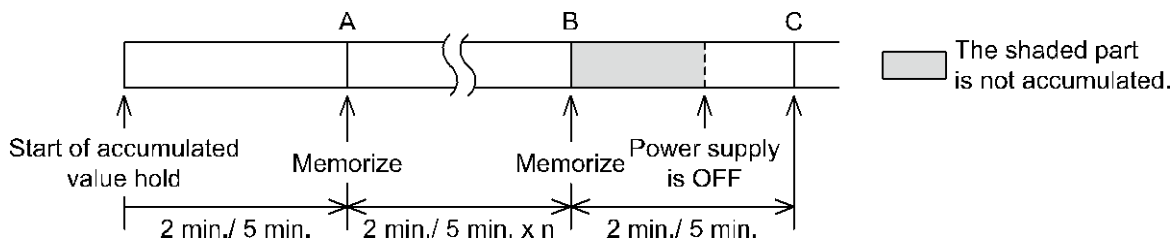

## ■[F80] Set display OFF mode

This function will turn the display OFF if no buttons are pressed for 30 seconds.

However when a flow monitor (PFG3 series) is connected, the displayed value might be different, due to an error. When the flow monitor display is used, it is recommended to set this product to the display OFF mode.

<Operation>

Display [F80] by pressing ▲ or ▼ button in function selection mode.

Press the S button. ↓ Move on to select display OFF mode.

### Select display OFF mode

Press the ▲ or ▼ button to select display OFF function.

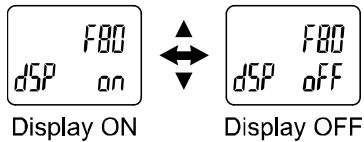

Press the S button to set. ↓ Return to function selection mode.

[F80] Set display OFF mode completed.

\*: In display OFF mode, the under bar of sub display flashes.

\*: When any button is activated, the display will turn on. If no button operation is performed within 30 seconds, the display will turn off again.

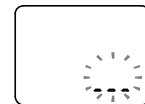

## ■[F81] Security code

The security code can be turned on and off and the security code can be changed when unlocked.

< Operation >

Display [F81] by pressing ▲ or ▼ button in function selection mode.

Press the S button. ↓ Move on to Setting of security code

### Setting of Security code

Press the ▲ or ▼ button to select the setting of security code.

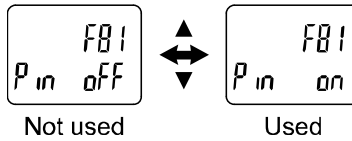

[oFF] is selected.  
Press the S button to  
return to function  
selection mode.

[on] is selected.  
Press the S button to set.

↓ Move on to check of the  
setting of security code.

### Check of the setting of security code

Press the ▲ or ▼ button to change the  
value.

Press the S button to move to the digit to  
the right.

(The default setting is [000])

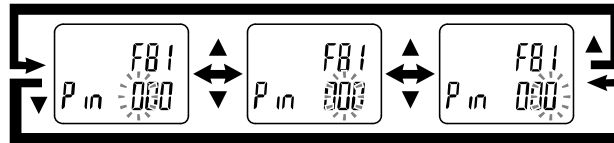

Press the S button for 1 second or longer.

- When the security code is correct, move on to the security code setting.
- If the security code entered is incorrect, [FAL] will be displayed, and the security code must be entered again.

If the wrong security code is entered 3 times, [nG] is displayed on the main display and the device returns to function selection mode.

↓ Move on to the setting of security code.

### Changing of security code.

New security code is displayed on the main display.  
Press the ▲ or ▼ button to change the value.  
Press the S button to move on to input the next digit.

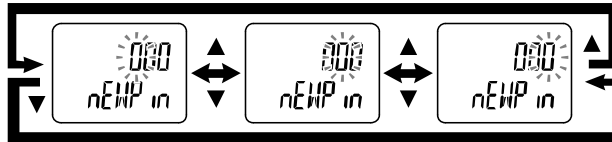

After entry, the changed security code will flash by pressing the S button for 1 second or longer.  
(At this point, the changing of the security code is not completed)  
Press the ▲ or ▼ button to return to setting step.



Press the S button to set. ↓ Return to function selection mode.

[F81] Security code complete

If the security code function is enabled, it is necessary to input a security code to release the key lock.

\*: If a key is not pressed for 30 seconds while entering the security code, function selection mode will return.

## ■[F90] Setting of all functions

Each time the S button is pressed, the function steps in the order shown in the following table.

<Operation>

Display [F90] by pressing ▲ or ▼ button in function selection mode.

Press the S button. ↓ Move on to the suction signal input check.

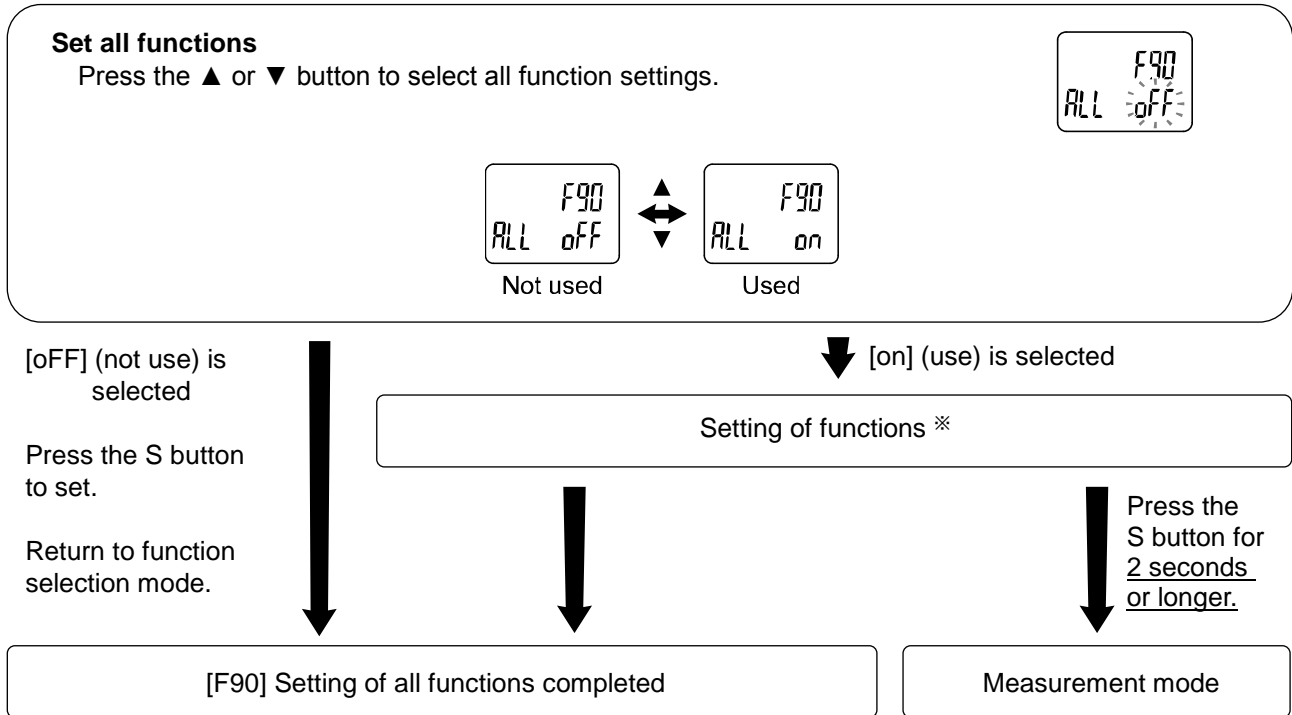

※: Setting of each function

Every time the S button is pressed, the display moves to the next function in order of "Function setting" on page 55.

Set by pressing ▲ and ▼ button.

For details of how to set each function, refer to the relevant setting of function section in this manual.

### Order of function settings

Order	Function	Applicable model
[F 0]	Reference condition	All models
	Unit selection function	Model with units selection function
[F 1]	OUT output mode	All models
	OUT switch operation	All models (When setting mode is selected, except output off mode)
	OUT set value	All models (When setting mode is selected, except accumulated pulse output mode and output off mode)
	OUT hysteresis	All models (in hysteresis mode or window comparator mode)
	OUT display colour	All models
[F 3]	Select response time	All models
[F 5]	Select FUNC	All models
[F10]	Select sub display (Line name setting)	All models
[F13]	Select reverse display	All models
[F14]	Select zero cut-off setting	All models
[F30]	Select accumulated value hold	All models
[F80]	Setting of display OFF mode	All models
[F81]	Setting of Security code	All models



## ■[F96] Check of input signal

When the external input is selected by the FUNC setting, the ON/OFF of the input signal can be checked.

\*: However when analogue output is selected, the ON/OFF of the input signal cannot be checked.

<Operation>

Display [F96] by pressing ▲ or ▼ button in function selection mode.

Press the S button. ↓ Move on to check of input signal.

### Check of input signal



F96  
S in OFF

The display shows OFF when there is no input signal, and it displays ON when there is an input signal.

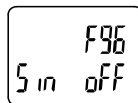

F96  
S in OFF

No input signal

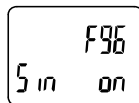

F96  
S in ON

With input signal

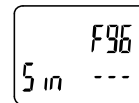

F96  
S in ---

When analogue output  
is selected

Press the S button to set. ↓ Return to function selection mode.

[F96] Check of input signal completed

## ■[F98] Setting of output check

The operation of the output can be checked by switching the output ON/OFF by pressing a button, without the need for a flow of fluid.

< Operation >

Display [F98] by pressing ▲ or ▼ button in function selection mode.

Press the S button. ↓ Move on to select of output check

### Select of output check

Press the ▲ or ▼ button to select all function setting

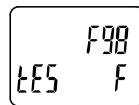
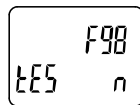

Normal output (Output not checked)      Forced output (Output is checked)

[n] (Normal output) is selected.

Press the S button to set.

Return to function selection mode.

[F] (Forced output) is selected. ↓ Move on to output check of OUT.  
Press the S button to set.

### Output check of OUT

Press the ▲ or ▼ button to select output check of OUT.



Forced output OFF      Forced output ON

↓ [F 5] (FUNC) external input is selected.  
Press the S button to set.  
Move on to function selection mode.

↓ [F 5] (FUNC) analogue output is selected.  
Press the S button to set.  
Move on to analogue output check.

**Analogue output check**

Press the ▲ or ▼ button to select analogue output check.

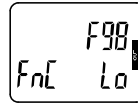

1 V (0 V)  
or  
4 mA output

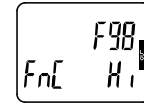

5 V (10 V)  
or  
20 mA output

0 V or 4 mA is output when [Lo], and 5 V (0 V) or 20 mA is output when [Hi].

\*: ( ) is an output value when 0 to 10 V is selected.

Press the S button to set.

Return to function selection mode.

[F98] Setting of output check completed

\*: Measurement mode can return from any setting item by pressing the S button for 2 seconds or longer.

\*: An increase or decrease in flow will have no effect on the output while the output operation is being performed.

## ■[F99] Reset to the default settings

If the Flow switch settings are uncertain, the default values can be restored.

<Operation>

Display [F99] by pressing ▲ or ▼ button in function selection mode.

Press the S button. ↓ Move on to reset to factory default settings.

### Rest to factory default settings.

Press the ▲ or ▼ button to display [ON], then press S and ▼ simultaneously for 5 seconds or longer.

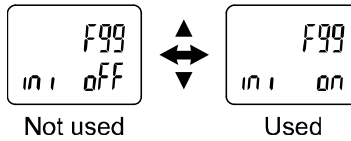

[oFF] (not use) is selected

Press the S button to set.

Return to function selection mode.

All settings are returned to the default values.  
Return to function selection mode.

[F99] Reset to the default settings completed

## Other Settings

- Reset operation

The Accumulated Flow, Peak Value and Bottom Value can be reset.

To reset the accumulated value, press the ▼ and S button for 1 second or longer.

- Snap shot function

The current flow rate value can be stored to the switch output ON/OFF set point.

When the items on the Sub display (left) are selected in either 3 step setting mode, Simple setting mode or Setting of each function mode, by pressing the ▲ and ▼ buttons simultaneously for 1 second or longer, the value of the sub display (right) will show "----", and the values corresponding to the current flow rate are automatically displayed.

Output mode	Configurable items	Sub display (left)	Snap shot function
Hysteresis mode	OUT set value	P(n)	○
	Hysteresis	H	○
Window comparator mode	OUT set value	PL(nL), PH(nH)	○
	Hysteresis	WH	×

- OUT1 set value

The value is set to the same value as the display value (current flow rate value).

(There is a range which cannot be set to the current flow rate depending on the hysteresis difference. In that case, the value is set to the closest value.)

- Hysteresis

The hysteresis is calculated from the equation below and set.

Normal output:  $(\text{OUT set value}) - (\text{current flow rate value})$

Reverse output:  $(\text{current flow rate value}) - (\text{OUT set value})$

If the calculation result becomes 0 or less, [Err] is displayed on the sub display and the set value is not changed.

Afterwards, it is possible to adjust the value by pressing ▲ or ▼ button.

●Key-lock function

The key lock function is used to prevent errors occurring due to unintentional changes of the set values. If S button is pressed while the keys are locked, [LoC] is displayed on the sub display (left) for approximately 1 second.

(Each setting and peak/ bottom values are displayed with ▲ and ▼ buttons.)

<Operation – Without security code input>

(1) Press the S button for 5 seconds or longer in measurement mode. When [oPE] is displayed on the main display, release the button.

The current setting [LoC] or [UnLoC] will be displayed on the sub display.

(To release key-lock repeat the above operation)

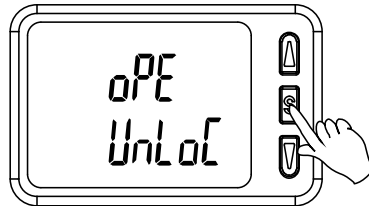

(2) Select the key locking/un-locking using the ▲ or ▼ button, and press the S button to set.

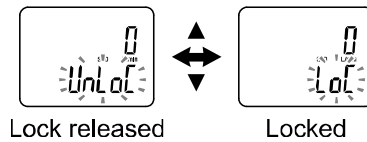

## <Operation – Without security code input>

### •Locking

- (1) Press the S button for 5 seconds or longer in measurement mode. When [oPE] is displayed on the main display, release the button.  
The current setting [LoC] or [UnLoC] will be displayed on the sub display.

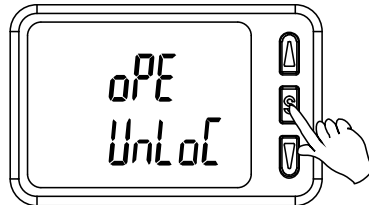

- (2) Select the key locking/ un-locking with ▲ or ▼ button, and press the S button to set.

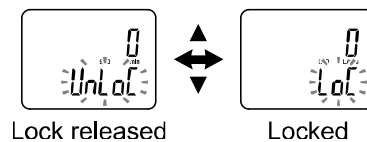

### •Unlocking

- (1) Press the S button for 5 seconds or longer in measurement mode. When [oPE] is displayed on the main display, release the button.  
The current setting [LoC] or [UnLoC] will be displayed on the sub display.

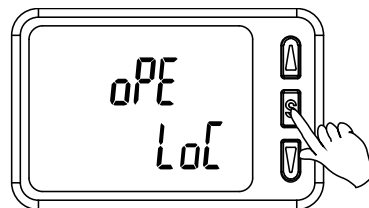

- (2) Select the un-locking [UnL] with ▲ or ▼ button. Setting is recognized by pressing the S button, then security code is required. When the security code is set, select the un-lock [UnLoC] with ▲ or ▼ button. Setting is recognized by pressing the S button, then the security code is required. If the security code is not set, select the un-lock [UnLoC]. Locking is released by pressing the S button.

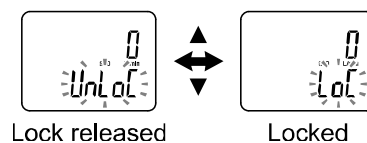

- (3) For the input method, refer to [F81] Security code (checking of the setting of security code) (page 52).

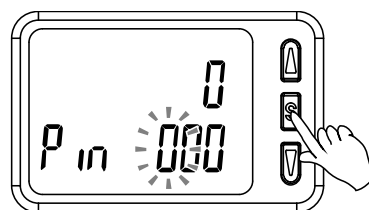

- (4) If inputted security code is correct, the indication of the main display changes to [UnLoC], and pressing one of ▲, S or ▼ button releases key lock and the measurement mode returns.  
If the security code entered is incorrect, [FAL] will be displayed on the main screen, and the security code must be entered again. If an incorrect security code is entered 3 times, [LoC] will be displayed on the main screen and the device will return to measurement mode.

## Maintenance

### How to reset the product after a power loss or when the power has been unexpectedly removed

The settings for the product are retained in memory prior to the power loss or de-energizing of the product. The output condition is also recoverable to that prior to the power loss or de-energizing. However, this may change depending on the operating environment. Therefore, check the safety of the whole installation before operating the product.

If the installation is using accurate control, wait until the product has warmed up (approximately 10 to 15 minutes) before operation.

## Forgotten the Security Code

Use the procedure below when the security code has been forgotten.

### <Operation>

Press the S button for 5 seconds or longer in measurement mode. When [oPE] is displayed on the main display, release the button.

The current setting [LoC] or [UnLoC] will be displayed on the sub display.

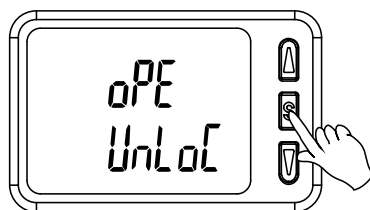

Press the ▲ or ▼ buttons simultaneously for 5 seconds or longer.

Press the S and ▼ buttons simultaneously for 5 seconds or longer.

\*: Display is not changed.

(If an other operation is performed or no operation is performed for 30 seconds, the display will return to measurement mode.)

Press the ▲ and S buttons simultaneously for 5 seconds or longer.

[000] is displayed and the security code change mode is available.

(If an operation is not performed for 30 seconds, the display will return to measurement mode.)

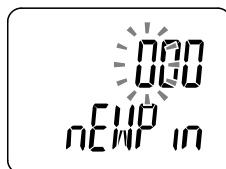

For the input method, refer to [F81] Security code (checking of the setting of security code) (page 52).

When input is completed, the selected security code flashes.

After checking the security code is as required, press the S button for 1 second or longer.

Return to measurement mode.

At this time, if the ▲ or ▼ button are pressed, any security code changes are lost, and the change of security code must be repeated.



## Troubleshooting

If an operation failure of the product occurs, please confirm the cause of the troubles from the following table. If a cause applicable to the troubles cannot be identified and normal operation can be recovered by replacement with a new product, this indicates that the product itself was faulty. Problems with the product may be due to the operating environment (installation etc). Please consult SMC.

### ●Cross-reference for troubleshooting

Error indication	Problem Possible causes	Investigation method	Countermeasure
<ul style="list-style-type: none"> <li>•The Auto switch output does not turn off. The indicator light stays ON</li> <li>•The switch output does not turn on Operation LED stays OFF</li> </ul>	Incorrect flow rate setting	(1) Check the flow rate setting. (2) Check the settings of the operation mode, hysteresis and output type. (in hysteresis mode or window comparator mode, and normal output/ reversed output)	(1) Adjust the set flow rate. (2) Change the response time setting.
	Product failure		Replace the product
The output does not turn off. Indicator light is normal	Incorrect wiring	Check the output wiring. Check if the load is directly connected to DC(+) or DC(-).	Check and correct the wiring.
	Product failure		Replace the product
The output does not turn on. Indicator light is normal	Incorrect wiring	Check the output wiring. Check if the load is directly connected to DC(+) or DC(-).	Check and correct the wiring.
	Model Selection	Check if PNP output is used when NPN should have been selected, or the other way around.	Revise the model selection (output specification).
	Lead wire broken	Check if there is bending stress applied to any part of the lead wire. (bending radius, tensile force to the lead wire)	Correct the wiring. (Reduce the tensile force or increase the bending radius.)
	Product failure		Replace the product
The switch output generates chattering.	Incorrect wiring	Check the wiring. Check if the brown and blue wires are connected to DC(+) and DC(-) respectively, and if the output line is secure (contact failure).	Correct the connection on the power cord and the plug.
	Incorrect flow rate setting	(1) Check the flow rate setting. (2) Check if the tolerance range is small.	(1) Adjust the set flow rate. (2) Make the tolerance wider.
	Product failure		Replace the product

Error indication	Problem Possible causes	Investigation method	Countermeasure
<ul style="list-style-type: none"> <li>•Over current error (Er1) is displayed</li> <li>•System error (Er0, 4 to 14) is displayed</li> <li>•"HHH" is displayed</li> </ul>	Excess current was applied to the output (Er1)	<ul style="list-style-type: none"> <li>(1) Check if the output current is 80 mA or greater.</li> <li>(2) Check if the connected load complies with the specification. Check if the load is short circuited.</li> <li>(3) Check if the relay without surge protection is connected.</li> <li>(4) Check if the wiring is in the same route as (or bundled together with) a high-voltage or power line.</li> </ul>	<ul style="list-style-type: none"> <li>(1)(2) Connect the appropriate load.</li> <li>(3) Use a relay with a surge voltage suppressor or take measures to prevent surge.</li> <li>(4) Separate the wiring from the high-voltage and/or power line.</li> </ul>
	Incorrect internal data processing of the product (Er0, 4 to 14)	<ul style="list-style-type: none"> <li>(1) Check if there is noise interference (such as static electricity). Check if there is a noise source nearby.</li> <li>(2) Check if the power supply voltage is in the range 24 VDC <math>\pm</math>10%.</li> </ul>	<ul style="list-style-type: none"> <li>(1) Remove the noise and the noise source (or take measures to prevent noise interference), and reset the product (or turn off and then turn back on the power supply).</li> <li>(2) Check that the Power supply voltage is 24 VDC <math>\pm</math>10%.</li> </ul>
	Applied flow rate is higher than the upper limit (HHH)	<ul style="list-style-type: none"> <li>(1) Check if the flow rate exceeds the upper limit of the set flow rate.</li> <li>(2) Check if foreign matter has entered the piping.</li> </ul>	<ul style="list-style-type: none"> <li>(1) Reset applied flow rate to a level within the settable flow range.</li> <li>(2) Take measures to prevent foreign matter from entering the piping.</li> </ul>
	Product failure		Replace the product
The display is unstable.	Incorrect power supply	Check if the power supply voltage is in the range 24 VDC $\pm$ 10%.	Power supply voltage is 24 VDC $\pm$ 10%.
	Incorrect wiring	Check the power supply wiring Check if the brown and blue wires are connected to DC(+) and DC(-) respectively, and if the wiring is secure	Check and correct the wiring.
	Factory line pressure is not stable	Check if the factory line pressure is changing.	Setting of the response time may improve the condition.

Error indication	Problem Possible causes	Investigation method	Countermeasure
The display turns off. Part of the display is missing.	Incorrect power supply	Check if the power supply voltage is 24 VDC $\pm 10\%$ .	Power supply voltage is 24 VDC $\pm 10\%$ .
	Incorrect wiring	Check the power supply wiring Check if the brown and blue wires are connected to DC(+) and DC(-) respectively, and if the wiring is secure	Check and correct the wiring.
	Display off mode	Check if display off mode is selected.	Select the power saving mode again.
	Product failure		Replace the product
Display flashes	Incorrect wiring	(1) Check the power supply wiring. (2) Check if there is bending stress applied to any part of the lead wire.	(1) Check and correct the wiring. (2) Correct the wiring (bend radius and stress).
The flow rate display accuracy does not meet the specifications.	Foreign matter entered	Confirmed foreign matter entry or sticking to the piping port.	Use a filter to prevent foreign matter from entering or sticking. Discharge the condensate of the filter periodically.
	Air leakage	Check if air is leaking from the piping.	Rework the piping. If the tightening torque is exceeded, the mounting screws, brackets and the flow switch may be damaged.
	Warming up inadequate	Check if the product satisfies the specified accuracy 10 minutes after supplying power.	After energizing, the display and output can drift. Allow the product to warm up for 10 to 15 minutes.
	Product failure		Replace the product
Display measurement unit cannot be changed.	Model Selection (model selected does not have unit conversion function)	Check if the product number printed on the product indicates Unit selection function type.	Unit selection function is not available for Fixed to SI units type. *: The unit conversion function is not for use in Japan due to a new measurement law. *: Unit fixed to SI:L/min
	Product failure		Replace the product

Error indication	Problem Possible causes	Investigation method	Countermeasure
Buttons do not work	Key-lock mode is activated.	Check if the key-lock function is turned on.	Check the key-lock function.
	Product failure		Replace the product
There is noise.	Air leakage	Check if air is leaking from the piping.	Rework the piping. If the tightening torque is exceeded, the mounting screws and the switch may be damaged.
	Product failure		Replace the product
The operation is unstable. (chattering)	Effect of line pressure fluctuation because hysteresis is too narrow.	Check the set flow rate (hysteresis).	Check the flow rate setting.
	Incorrect wiring/ broken lead wire	(1) Check the power supply wiring. (2) Check if there is bending stress applied to any part of the lead wire. (bending radius, tensile force to the lead wire)	(1) Check and correct the wiring. (2) Correct the wiring. (Reduce the tensile force or increase the bending radius.)
	Product failure		Replace the product

## ■ Error display

Error name	Error display	Description	Measures
Instantaneous flow error		Flow rate exceeding the upper limit of the settable flow range is applied.	Reset applied flow rate to a level within the settable flow range.
Over current error		The switch output load current is 80 mA or more.	Turn the power off and remove the cause of the over current. Then supply the power again.
System error		An internal data error has occurred.	Turn the power off and on again. If the failure cannot be solved, contact SMC.
Accumulated flow error		The accumulated flow has exceeded the accumulated flow range. (For accumulated increment)	Reset the accumulated flow. (Press the ▼ and S buttons simultaneously for 1 second or longer)
		The accumulated flow has reached the set accumulated flow. (For accumulated decrement)	

\*: If the error cannot be reset after the above measures are taken, then please contact SMC.

## Specifications

Models		PF3A703H	PF3A706H	PF3A712H	
Fluid	Applicable fluid *1	Air, N <sub>2</sub>			
	Operating fluid temperature	0 to 50 °C			
Flow	Detection method	Heating type sensor			
	Rated flow range	30 to 3000 L/min	60 to 6000 L/min	120 to 12000 L/min	
	Set point range	Instantaneous flow	30 to 3150 L/min	60 to 6300 L/min	120 to 12600 L/min
		Accumulated flow	0 to 999,999,999,990 L		
	Minimum resolution	Instantaneous flow	2 L/min	5 L/min	10 L/min
		Accumulated flow	10 L	100 L	
	Accumulated volume per pulse (Pulse width = 50 msec.)	Select from 100 L/pulse and 1000 L/pulse			
	Accumulated value hold *2	2 minutes or 5 minutes			
Pressure	Rated pressure range	0.1 to 1.5 MPa			
	Proof pressure	2.25 MPa			
	Pressure loss	Refer to the pressure loss graph			
	Pressure Characteristics *3	±2.5%F.S. (0.1 to 1.0 MPa, 0.5 MPa standard)			
Electrical specifications	Power supply voltage	24 VDC ±10%			
	Current consumption	150 mA or less			
	Protection	Polarity protection			
Accuracy	Display accuracy	±3.0%F.S.			
	Analogue output accuracy	±3.0%F.S.			
	Repeatability	Display, switch output, analogue output: ±1.0%F.S.			
	Temperature characteristics	±5.0%F.S. (Ambient temp. 0 to 50 °C, 25 °C standard)			
Switch output	Output type	NPN open collector PNP open collector			
	Output mode	Instantaneous output (hysteresis mode, window comparator mode) Select from Accumulated output or accumulated pulse output mode			
	Switch operation	Normal or Reversed Output			
	Maximum load current	80 mA			
	Maximum applied voltage (Only NPN)	28 VDC			
	Internal voltage drop (Residual voltage)	NPN output: 1 V or less (at 80mA) PNP output: 2 V or less (at 80mA)			
	Response time *4	1 s, 2 s or 5 s			
	Hysteresis *5	Variable			
Protection	Over current protection				

Models		PF3A703H	PF3A706H	PF3A712H	
Analogue output *6	Output type		Voltage output: 1 to 5 V (0 to 10 V can also be selected *7), Current output: 4 to 20 mA		
	Impedance	Output voltage	Output impedance approx. 1 kΩ		
		Current output	Max. load impedance 600 Ω		
	Response time *8		Linked with the response time of the switch output.		
Ext. input *9	Input type		Input with no voltage: 0.4 V or less		
	Input mode		Select from the Reset of Accumulated Value, Reset Peak and Reset Bottom values		
	Time for input		30 ms or more		
Display	Reference condition *10		Normal or Standard condition		
	Unit *11	Instantaneous flow	L/min, cfm (ft <sup>3</sup> /min)		
		Accumulated flow	L, ft <sup>3</sup>		
	Display range *12	Instantaneous flow	0 to 3150 L/min (Displays 0 when the value is below 30 L/min.)	0 to 6300 L/min (Displays 0 when the value is below 60 L/min.)	0 to 12600 L/min (Displays 0 when the value is below 120 L/min.)
		Accumulated flow	0 to 999,999,999,990 L		
	Minimum display unit	Instantaneous flow	2 L/min	5 L/min	10 L/min
		Accumulated flow	10 L	100 L	
	Display		Display method: LCD Number of displays: 2 (Main display and Sub display) Colour: Red and green for main display Display colour (sub display): Orange Display (main display): 5 digits 7 segment Display (sub display): 6 digits 7 segment		
	Operation LED		OUT LED: Orange is ON when output is ON		
	Environmental resistance	Protection		IP65	
Withstand voltage		1000 V AC for 1 minute between terminals and housing			
Insulation resistance		50 MΩ between terminals and housing (with 500 VDC megger)			
Operating temperature range		Operation: 0 to 50 °C, Storage: -10 to 60 °C (No condensation or freezing)			
Operating humidity range		Operation, Storage: 35 to 85%RH (No condensation)			
Standards		CE marked (EMC directive, RoHS directive)			
Piping	Piping specification		Rc1, NPT1, G1	Rc1 1/2, NPT1 1/2, G1 1/2	Rc2, NPT2, G2
Materials in contact with fluid		Aluminum alloy, PPS, HNBR (Sensor: Pt, Au, Ni, Fe, lead glass (not RoHS compliant), Al2O3)			
Lead wire with connector		3 m			
Weight	Piping port sizes	Rc	610 g	1190 g	1680 g
		NPT	610 g	1190 g	1680 g
		G	630 g	1220 g	1720 g
	Lead wire with connector		+90 g		

- \*1: The air quality class is according to JIS B 8392-1:2012 [3:6:-] and ISO8573-1:2010 [3:6:-].
- \*2: When using the accumulated value hold function, calculate the product life from the operating conditions, and use the product within its life. Maximum updating time of accumulated value is 1.5 million times.  
 If the product is energized for 24 hours per day, the product life will be as follows:  
 •Data memorized every 5 minutes --- 5 minutes x 1.5 million times = 7.5 million minutes = 14.3 years  
 •Data memorized every 2 minutes --- 2 minutes x 1.5 million times = 3 million minutes = 5.7 years  
 If the Accumulated Flow External Reset is repeatedly used, the product life will be shorter than calculated life.
- \*3: When the pressure range is 1.0 to 1.5 MPa. The pressure characteristics will be  $\pm 5\%$ F.S. to the standard pressure of 0.5 MPa.  
 Do not release the OUT side piping port of the product directly to the atmosphere without connecting piping. If the product is used with the piping port released to atmosphere, accuracy may vary.
- \*4: The time from when the flow is changed by a step input (when the flow rate changes from 0 to the maximum flow instantaneously) until the switch output, turns ON (or OFF) when set at 90% of the rated flow rate.
- \*5: If the applied voltage fluctuates around the set value, the width for setting more than the fluctuating width needs to be set. Otherwise, chattering will occur.
- \*6: Analogue output or external input can be selected by pressing the buttons. Refer to the graph for analogue output.
- \*7: When selecting 0 to 10V, refer to the analogue output graph for the allowable load current.
- \*8: The time from when the flow is changed as a step input (when the flow rate changes from 0 to the maximum flow instantaneously) until the analogue output reaches 90% of the rated flow rate.
- \*9: Analogue output or external input can be selected by pressing the buttons.
- \*10: The flow rate given in the specification is the value at standard condition (STD).
- \*11: Setting is only possible for models with the unit selection function.
- \*12: Displayable range change based on the setting of zero cut-off function.

Cable specification for M12 connector and lead wire (ZS-37-A)

Item		Specifications
Conductor	Nominal cross section	AWG23
Insulator	O.D.	Approx. 1.1 mm
	Colours	Brown, blue, black, white
Sheath	Finish O.D.	$\varnothing 4$



## ■ Characteristics data

### ● Flow rate/ Analogue output

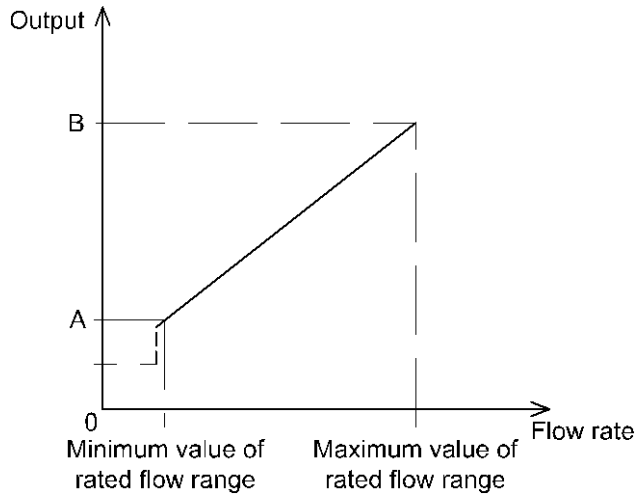

	0 L/min	A *2	B
Voltage output (1 to 5 V) *1	1 V	1.04 V	5 V
Current output *1	4 mA	4.16 mA	20 mA

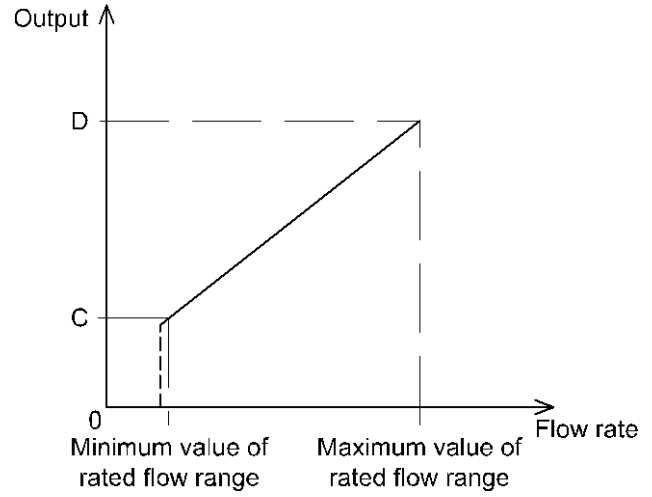

	0 L/min	C *2	D
Voltage output (0 to 10 V) *1, *3	0 V	0.1 V	10 V

Models	Minimum value of rated flow range *4	Maximum value of rated flow range
PF3A703H	30 L/min	3000 L/min
PF3A706H	60 L/min	6000 L/min
PF3A712H	120 L/min	12000 L/min

\*1: Analogue output accuracy is within  $\pm 3\%$ F.S.

\*2: A and C change based on the setting of zero cut-off function.

\*3: Set the current to the analogue output from the connected equipment to 20  $\mu$ A or less when selecting 0 to 10 V.

When 20  $\mu$ A or more current flows, it is possible that the accuracy is not satisfied in the area at 0.5 V or lower.

\*4: The minimum value of the rated flow range changes based on the setting of zero cut-off function.

● Pressure loss (reference value)

• PF3A703H (For 3000 L/min)

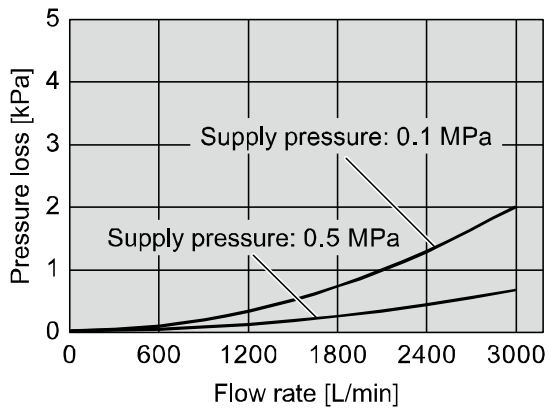

• PF3A706H (For 6000 L/min)

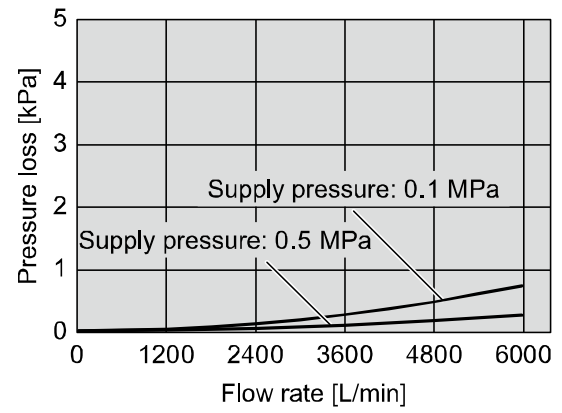

• PF3A712H (For 12000 L/min)

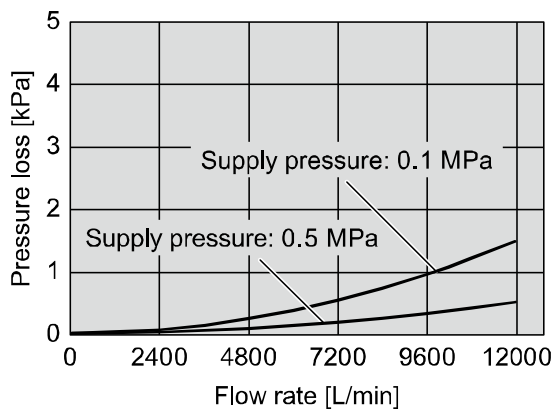

- IN side straight pipe length and accuracy (reference value)

- Do not connect equipment or piping which may generate a fluctuation in the flow or drift at the IN side of the product.

When installing the regulator at the IN side of the product, make sure that hunting is not generated.

- The piping on the IN side must have a straight section of piping whose length is 8 times the piping I.D. or more.

If a straight section of piping is not installed, the accuracy varies by approximately  $\pm 3\%$  or more.

\*: "Straight section" means a part of the piping without any bends or rapid changes in the cross sectional area.

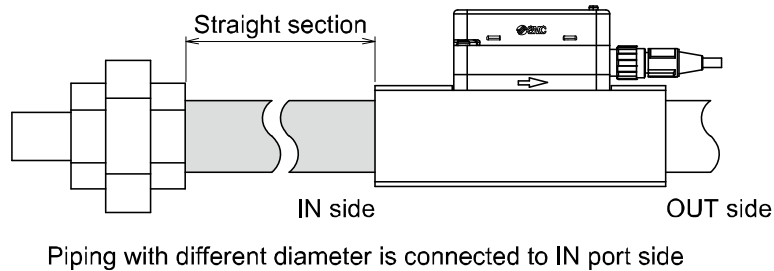
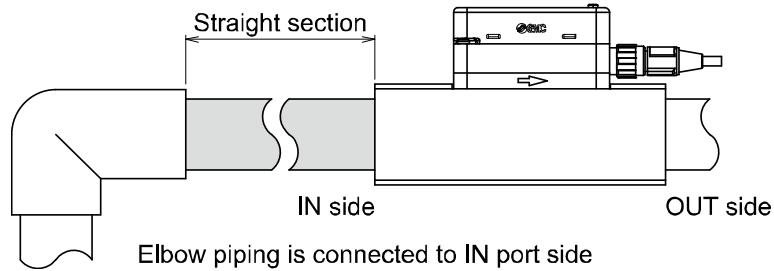

- PF3A703H (For 3000 L/min)

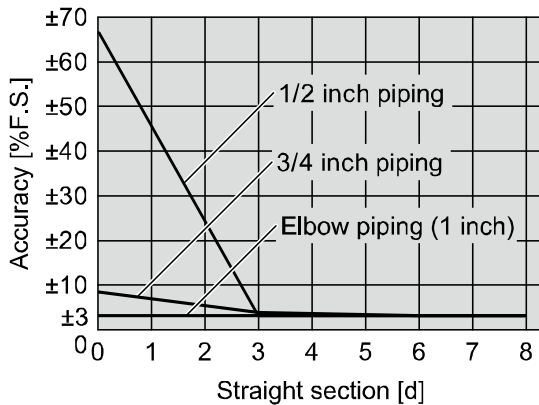

- PF3A706H (For 6000 L/min)

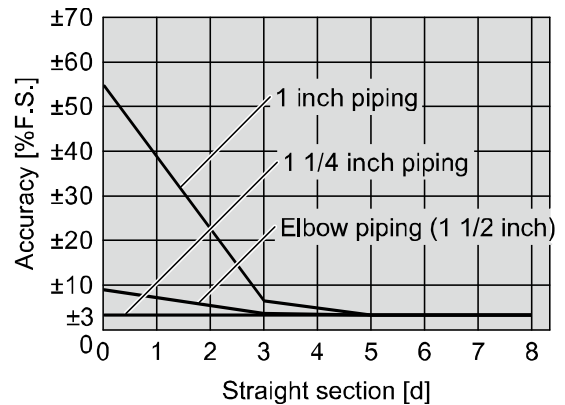

- PF3A712H (For 12000 L/min)

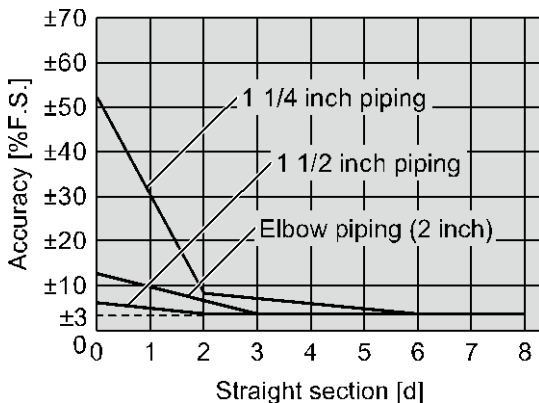

## ■Dimensions

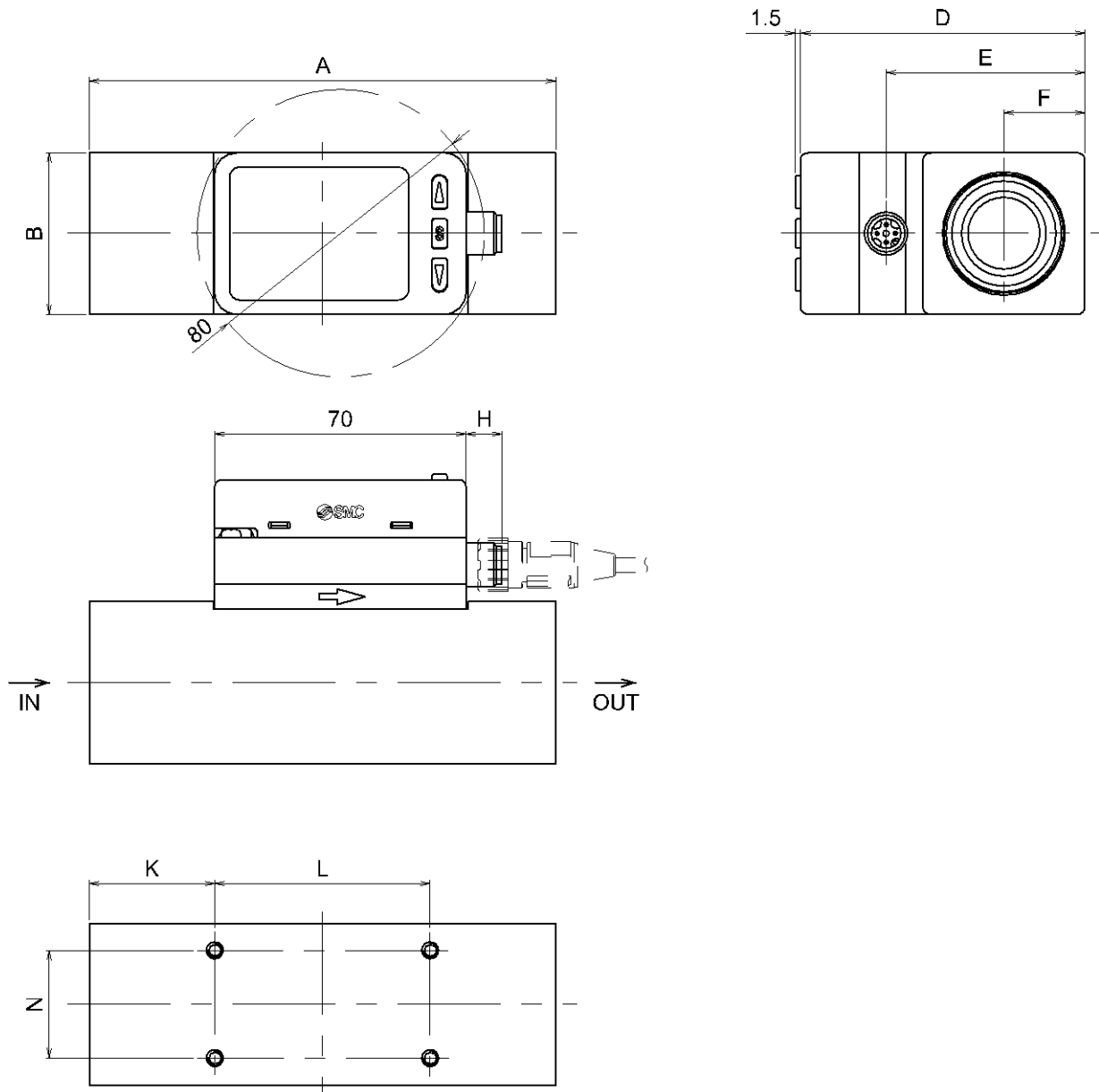

Symbol	A	B	D	E	F	H	K	L	N	
Models										
PF3A703H	130	45	79.1	55.3	22.5	25	35	60	30	4 x M4 x 0.7 depth 7
PF3A706H	170	60	94.1	70.3	30	68	45	80	40	4 x M5 x 0.8 depth 8
PF3A712H	200	70	104.1	80.3	35	85	50	100	50	4 x M6 x 1.0 depth 9

Lead wire with M12 connector (ZS-37-A)

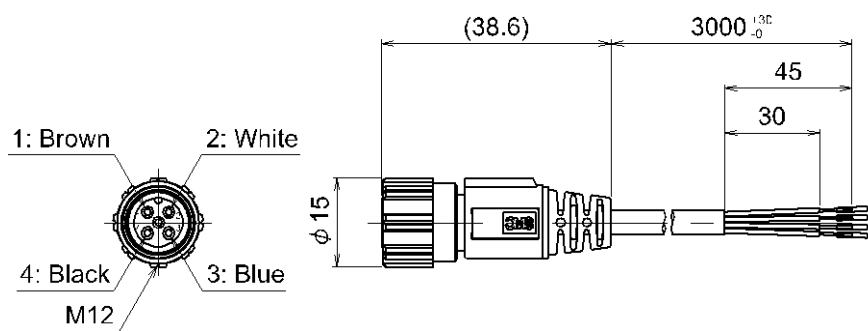

Pin number	Description	Colour
1	DC(+)	Brown
2	FUNC	White
3	DC(-)	Blue
4	OUT	Black

\*: 4-wire lead wire with M12 connector for PF3A series.

#### Revision history

A: Modified errors in text. [October 2017]  
B: Contents revised in several places. [July 2018]  
C: Contents revised in several places.  
[August 2019]

## SMC Corporation

4-14-1, Sotokanda, Chiyoda-ku, Tokyo 101-0021 JAPAN

Tel: + 81 3 5207 8249 Fax: +81 3 5298 5362

URL <https://www.smcworld.com>

---

Note: Specifications are subject to change without prior notice and any obligation on the part of the manufacturer.  
© 2017-2019 SMC Corporation All Rights Reserved

