



# Operation Manual

PRODUCT NAME

Digital Pressure Switch

MODEL / Series / Product Number

*ZSE80(F)*  
*ISE80(H)*

**SMC Corporation**

## Table of Contents

Safety Instructions	2
Model Indication and How to Order	9
Summary of Product parts	10
Definition and terminology	11
Mounting and Installation	14
Installation	14
Piping	16
Wiring	17
Pressure Setting	19
Measurement mode	19
Function Setting	21
Function selection mode	21
Default setting	21
F0 Units selection function	23
F1 Setting of OUT1	24
F2 Setting of OUT2	27
F3 Response time	27
F4 Analogue output / Auto-shift input	28
F5 Display resolution	30
F7 Fine adjustment of display value	31
F8 Auto-preset function	32
F9 Power saving mode	34
F10 Security code	35
Special function setting	36
F98 Setting of all functions	36
F99 Reset to the default setting	38
Other Settings	39
Maintenance	42
If the security code is forgotten	42
Troubleshooting	43
Specification	50
Specifications	50
Dimensions	52



# Safety Instructions

These safety instructions are intended to prevent hazardous situations and/or equipment damage. These instructions indicate the level of potential hazard with the labels of "Caution", "Warning" or "Danger". They are all important notes for safety and must be followed in addition to International Standards (ISO/IEC)\*1), and other safety regulations.

\*1) ISO 4414: Pneumatic fluid power -- General rules relating to systems.  
ISO 4413: Hydraulic fluid power -- General rules relating to systems.  
IEC 60204-1: Safety of machinery -- Electrical equipment of machines .(Part 1: General requirements)  
ISO 10218: Manipulating industrial robots -Safety.  
etc.



## Caution

**Caution** indicates a hazard with a low level of risk which, if not avoided, could result in minor or moderate injury.



## Warning

**Warning** indicates a hazard with a medium level of risk which, if not avoided, could result in death or serious injury.



## Danger

**Danger** indicates a hazard with a high level of risk which, if not avoided, will result in death or serious injury.

## Warning

### 1. The compatibility of the product is the responsibility of the person who designs the equipment or decides its specifications.

Since the product specified here is used under various operating conditions, its compatibility with specific equipment must be decided by the person who designs the equipment or decides its specifications based on necessary analysis and test results.

The expected performance and safety assurance of the equipment will be the responsibility of the person who has determined its compatibility with the product.

This person should also continuously review all specifications of the product referring to its latest catalog information, with a view to giving due consideration to any possibility of equipment failure when configuring the equipment.

### 2. Only personnel with appropriate training should operate machinery and equipment.

The product specified here may become unsafe if handled incorrectly.

The assembly, operation and maintenance of machines or equipment including our products must be performed by an operator who is appropriately trained and experienced.

### 3. Do not service or attempt to remove product and machinery/equipment until safety is confirmed.

1. The inspection and maintenance of machinery/equipment should only be performed after measures to prevent falling or runaway of the driven objects have been confirmed.

2. When the product is to be removed, confirm that the safety measures as mentioned above are implemented and the power from any appropriate source is cut, and read and understand the specific product precautions of all relevant products carefully.

3. Before machinery/equipment is restarted, take measures to prevent unexpected operation and malfunction.

### 4. Contact SMC beforehand and take special consideration of safety measures if the product is to be used in any of the following conditions.

1. Conditions and environments outside of the given specifications, or use outdoors or in a place exposed to direct sunlight.

2. Installation on equipment in conjunction with atomic energy, railways, air navigation, space, shipping, vehicles, military, medical treatment, combustion and recreation, or equipment in contact with food and beverages, emergency stop circuits, clutch and brake circuits in press applications, safety equipment or other applications unsuitable for the standard specifications described in the product catalog.

3. An application which could have negative effects on people, property, or animals requiring special safety analysis.

4. Use in an interlock circuit, which requires the provision of double interlock for possible failure by using a mechanical protective function, and periodical checks to confirm proper operation.



# Safety Instructions

## Caution

### **1. The product is provided for use in manufacturing industries.**

The product herein described is basically provided for peaceful use in manufacturing industries. If considering using the product in other industries, consult SMC beforehand and exchange specifications or a contract if necessary.  
If anything is unclear, contact your nearest sales branch.

## **Limited warranty and Disclaimer/Compliance Requirements**

The product used is subject to the following "Limited warranty and Disclaimer" and "Compliance Requirements".

Read and accept them before using the product.

### **Limited warranty and Disclaimer**

#### **1. The warranty period of the product is 1 year in service or 1.5 years after the product is delivered, whichever is first.\*2)**

Also, the product may have specified durability, running distance or replacement parts. Please consult your nearest sales branch.

#### **2. For any failure or damage reported within the warranty period which is clearly our responsibility, a replacement product or necessary parts will be provided.**

This limited warranty applies only to our product independently, and not to any other damage incurred due to the failure of the product.

#### **3. Prior to using SMC products, please read and understand the warranty terms and disclaimers noted in the specified catalog for the particular products.**

##### **\*2) Vacuum pads are excluded from this 1 year warranty.**

A vacuum pad is a consumable part, so it is warranted for a year after it is delivered.

Also, even within the warranty period, the wear of a product due to the use of the vacuum pad or failure due to the deterioration of rubber material are not covered by the limited warranty.

### **Compliance Requirements**

#### **1. The use of SMC products with production equipment for the manufacture of weapons of mass destruction (WMD) or any other weapon is strictly prohibited.**

#### **2. The exports of SMC products or technology from one country to another are governed by the relevant security laws and regulation of the countries involved in the transaction. Prior to the shipment of a SMC product to another country, assure that all local rules governing that export are known and followed.**

## Caution

### **SMC products are not intended for use as instruments for legal metrology.**

Products that SMC manufactures or sells are not measurement instruments that are qualified by pattern approval tests relating to the measurement laws of each country.

Therefore, SMC products cannot be used for business or certification ordained by the measurement laws of each country.

## Operator

- ◆ This operation manual is intended for those who have knowledge of machinery using pneumatic equipment, and have sufficient knowledge of assembly, operation and maintenance of such equipment. Only those persons are allowed to perform assembly, operation and maintenance.
- ◆ Read and understand this operation manual carefully before assembling, operating or providing maintenance to the product.

### ■ Safety Instructions

#### **Warning**

- Do not disassemble, modify (including changing the printed circuit board) or repair.  
An injury or failure can result.
- Do not operate the product outside of the specifications.  
Do not use for flammable or harmful fluids.  
Fire, malfunction, or damage to the product can result.  
Verify the specifications before use.
- Do not operate in an atmosphere containing flammable or explosive gases.  
Fire or an explosion can result.  
This product is not designed to be explosion proof.
- Do not use the product in a place where static electricity is a problem.  
Otherwise it can cause failure or malfunction of the system.
- If using the product in an interlocking circuit:
  - Provide a double interlocking system, for example a mechanical system
  - Check the product regularly for proper operationOtherwise malfunction can result, causing an accident.
- The following instructions must be followed during maintenance:
  - Turn off the power supply
  - Stop the air supply, exhaust the residual pressure and verify that the air is released before performing maintenanceOtherwise an injury can result.

## ⚠ Caution

- Do not touch the terminals and connectors while the power is on.  
Otherwise electric shock, malfunction or damage to the product can result.
- After maintenance is complete, perform appropriate functional inspections and leak tests.  
Stop operation if the equipment does not function properly or there is a leakage of fluid.  
When leakage occurred from other parts except piping, the product might break.  
Cut off power supply and stop supplying fluid.  
Do not apply fluid at leaking condition.  
Safety cannot be assured in the case of unexpected malfunction.
- Use ferules made by Swagelock® (trade name: Swagelock® fittings) for TSJ fittings, packing and glands made by Cajon (trade name: Cajon VCR® fittings) for URJ fittings.  
Otherwise safety may not be secured due to leakage from joint.  
When using ferules, packing or glands made by other manufacture, be sure to perform helium leak test to verify no leakage.

## ■ NOTE

○ Follow the instructions given below when designing, selecting and handling the product.

- The instructions on design and selection (installation, wiring, environment, adjustment, operation, maintenance, etc.) described below must also be followed.

\*Product specifications

- The direct current power supply to combine should be UL approved as follows.

Circuit (of Class2) which is of maximum 30 Vrms (42.4 V peak) or less, with UL1310 Class2 power supply unit or UL1585 Class2 transformer.

- The Pressure switch is a  approved product only if it has a  mark on the body.

- Use the specified voltage.

Otherwise failure or malfunction can result.

- Do not exceed the specified maximum allowable load.

Otherwise it can cause damage or shorten the lifetime of the Pressure switch.

- Design the product to prevent reverse current when the circuit is opened or the product is forced to operate for operational check.

Reverse current can cause malfunction or damage to the product.

- Input data to the Pressure switch is not deleted, even if the power supply is cut off.  
(Writing time: 1,000,000 times)

- A pressure sensor of stainless steel diaphragm is used for this switch. The pressure sensor of this switch can be damaged by the rush inertia of water when the drain contained in water and air collide with the pressure sensor when vacuum is broken after vacuum adsorption is confirmed, and it may cause malfunction with the pressure indication. If there is a possibility of water or drainage getting in, narrow the diameter of the piping to the pressure switch, or make an orifice in the middle of the piping shown in the Fig. right. Extra attention is needed when the rear piping type model is used.

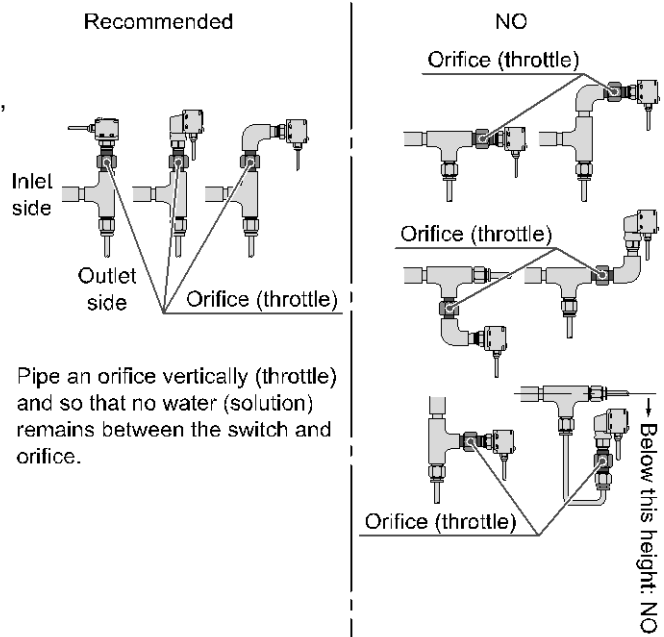

- Some fluids may generate static electricity when resin piping is used for piping. Take measures against static electricity with equipment when this switch is used in connection with resin piping. Also, the ground should be separate from that of the units that generate strong electromagnetic noise or high frequency, otherwise, the switch can be damaged by static electricity.
- Applicable fluid is a fluid that does not corrode SUS630 and SUS304.  
Do not use a fluid containing chemicals, synthetic oils including organic solvent, salt and corrosive gases. Otherwise, damage to the product and malfunction can result.  
Check the details of the specifications before using.
- Use the specified measurement flow rate and operating pressure.  
Otherwise it can cause damage to the Pressure switch or inability to measure correctly.
- Reserve a space for maintenance.  
Allow sufficient space for maintenance when designing the system.

## ●Product handling

### \*Installation

- Tighten to the specified tightening torque.  
If the tightening torque is exceeded the mounting screws and brackets may be broken.  
If the tightening torque is insufficient, the product can be displaced and loosen the mounting screws.  
(Refer to "Mounting and Installation" on page 14.)
- Do not apply excessive stress to the product when it is mounted with a panel mount.  
Otherwise damage to the product and disconnection from the panel mount can result.
- Be sure to ground terminal FG when using a commercially available switch-mode power supply.
- Do not drop, hit or apply shock to the Pressure switch.  
Otherwise damage to the internal parts can result, causing malfunction.
- Do not pull the lead wire forcefully, not lift the product by pulling the lead wire. (Tensile force 49 N or less)  
Hold the body when handling to avoid the damage of the Pressure switch which lead to cause the failure and malfunction.
- For piping of the Pressure switch, hold the piping with a spanner on the metal part of the piping (Piping attachment).  
Holding other part with spanner leads to damage the Pressure switch.
- Eliminate any dust left in the piping by air blow before connecting the piping to the product.  
Otherwise it can cause damage or malfunction.
- Do not insert metal wires or other foreign matter into the pressure measurement port.  
It can damage the pressure sensor causing failure or malfunction.
- Never mount a product in a location that will be used as a foothold.  
The product may be damaged if excessive force is applied by stepping or climbing onto it.
- If the entering of foreign material to the fluid is possible, install and pipe the filter or the mist separator to the inlet to avoid failure and malfunction.
- Helium leakage test is conducted on the welding parts. Use a ferrule by Swagelok Company (Swagelok® fittings) as the TSJ fittings and packing, ground, etc. by Swagelok Company (VCR® fittings) as the URJ fittings. If a ferrule, packing or ground by other manufacturers are to be used, conduct helium leakage test before using those products.

\*: Swagelok® and VCR® are trademarks of Swagelok Company.

#### \*Wiring

- Do not pull the lead wires.

In particular, never lift a Pressure switch equipped with fitting and piping by holding the lead wires. Otherwise damage to the internal parts can result, causing malfunction.

- Avoid repeatedly bending or stretching the lead wire, or placing heavy load on them.

Repetitive bending stress or tensile stress can cause the sheath of the wire to peel off, or breakage of the wire. If the lead wire can move, fix it near the body of the product.

The recommended bend radius of the lead wire is 6 times the outside diameter of the sheath, or 33 times the outside diameter of the insulation material, whichever is larger.

- Wire correctly.

Incorrect wiring can break the Pressure switch.

- Do not perform wiring while the power is on.

Otherwise damage to the internal parts can result, causing malfunction.

- Do not route wires and cables together with power or high voltage cables.

Otherwise the product can malfunction due to interference of noise and surge voltage from power and high voltage cables to the signal line. Route the wires (piping) of the product separately from power or high voltage cables.

- Confirm proper insulation of wiring.

Poor insulation (interference from another circuit, poor insulation between terminals, etc.) can lead to excess voltage or current being applied to the product, causing damage.

- Design the system to prevent reverse current when the product is forced to operate for operational check.

Depending on the circuit used, insulation may not be maintained when operation is forced, allowing reverse current to flow, which can cause malfunction and damage the product.

- Keep wiring as short as possible to prevent interference from electromagnetic noise and surge voltage.

Do not use a cable longer than 30 m.

Wire the DC (-) line (blue) as close as possible to the power supply.

- When analogue output is used, install a noise filter (line noise filter, ferrite element, etc.) between the switch-mode power supply and this product.

#### \*Environment

- Do not use the product in an environment that is constantly exposed to the splash of water.

Otherwise failure or malfunction can result. Take measures such as using a cover.

- Do not use the product in an environment where corrosive gases or fluids could be splashed.

Otherwise damage to the product and malfunction can result.

- Do not use in a place where the product could be splashed by oil or chemicals.

If the product is to be used in an environment containing oils or chemicals such as coolant or cleaning solvent, even for a short time, it may be adversely affected (damage, malfunction, or hardening of the lead wires)

- Do not use in an area where surges are generated.

If there is equipment which generates a large amount of surge (solenoid type lifter, high frequency induction furnace, motor, etc.) close to the Pressure switch, this may cause deterioration or breakage of the internal circuit of the Pressure switch. Avoid sources of surge generation and crossed lines.

- Do not use a load which generates surge voltage.

When a surge-generating load such as a relay or solenoid is driven directly, use a Pressure switch with a built-in surge absorbing element.

- The product is CE marked, but not immune to lightning strikes. Take measures against lightning strikes in the system.

- Mount the product in a place that is not exposed to vibration or impact.

Otherwise failure or malfunction can result.

- Prevent foreign matter such as remnant of wires from entering the Pressure switch.

Take proper measures for the remnant not to enter the Pressure switch in order to prevent failure or malfunction.

- Do not use the product in an environment that is exposed to temperature cycle.

Heat cycles other than ordinary changes in temperature can adversely affect the inside of the product.



- Do not expose the product to direct sunlight.  
If using in a location directly exposed to sunlight, shade the product from the sunlight.  
Otherwise failure or malfunction can result.
- Keep within the specified fluid and ambient temperatures range.  
The fluid and ambient temperatures is 5 to 50 °C. Operation under low temperature (5 °C or less) leads to cause damage or operation failure due to frozen moist in the fluid or air.  
Protection against freezing is necessary. Air dryer is recommended for elimination of drain and water.  
Avoid sudden temperature change even within specified temperature.
- Do not operate close to a heat source, or in a location exposed to radiant heat.  
Otherwise malfunction can result.
- Use operating fluid which does not corrode the part in contact with fluid which is made of SUS630 (for sensing part) or SUS304 (for fitting part).  
(Compatibility between fluid and material can be checked by contact to fluid supplier.)
- When resin piping is used, depending on the fluid, static electricity may occur. When connecting the switch and sensor, please take adequate anti-static electricity measures on the equipment side, and do not use with a grounding that is shared with equipment that generates strong electromagnetic noise or high-frequency waves. This can result in a switch or sensor being damaged by static electricity.

**\*Adjustment and Operation**

- Turn the power on after connecting a load.  
Otherwise it can cause excess current causing instantaneous breakage of the Pressure switch.
- Do not short-circuit the load.  
Although error is displayed when the Pressure switch load is short circuit, generated excess current lead to cause the damage of the Pressure switch.
- Do not press the setting buttons with a sharp pointed object.  
It may damage the setting buttons.
- If using the product to detect very small pressure rates, warm up the product for 10 to 15 minutes first.  
There will be a drift on the display and the analogue output of approximate 1% immediately after the power supply is turned on.
- Perform settings suitable for the operating conditions.  
Incorrect setting can cause operation failure.  
For details of each setting, refer to page 19 to 38 of this manual.
- Do not touch the LCD during operation.  
The display can vary due to static electricity.

**\*Maintenance**

- Turn off the power supply, stop the supplied air, exhaust the residual pressure and verify the release of air before performing maintenance.  
There is a risk of unexpected malfunction.
- Perform regular maintenance and inspections.  
There is a risk of unexpected malfunction.
- Perform drainage regularly.  
If condensate enters the secondary side, it can cause operating failure of pneumatic equipment.
- Do not use solvents such as benzene, thinner etc. to clean the Pressure switch.  
They could damage the surface of the body and erase the markings on the body.  
Use a soft cloth to remove stains. For heavy stains, use a cloth soaked with diluted neutral detergent and fully squeezed, then wipe up the stains again with a dry cloth.

# Model Indication and How to Order

## Model Indication and How to order

ISE80 - 02 - □ - N - □ □ □

Set pressure range

Symbol	Content
ISE80	-0.1 to 1 MPa
ZSE80	0 to -101 kPa
ZSE80F	-100 to 100 kPa
ISE80H	-0.1 to 2 MPa

Piping specifications

Symbol	Content
02	R1/4
N02	NPT1/4
F02 *	G1/4
C01	Rc1/8
A2	URJ1/4
B2	TSJ1/4

\*: Only rear surface piping is available F02. ISO228-1 compliant.

Piping direction

Symbol	Content
Nil	Rear piping
L	Bottom piping

Option 3

Symbol	Content
Nil	With operation manual
Y	Without operation manual
K	With operation manual + calibration certificate
T	Without operation manual + with calibration certificate

\*: All texts in both English and Japanese.

Option 2

Symbol	Content
Nil	No option
A	Bracket (ZS-24-A/ZS-35-A)
B	Bracket * (ZS-24-D)
C	Panel mount adapter
D	Panel mount adapter + Front protective cover

\*: Rear piping only.

Option 1

Symbol	Content
Nil	With unit conversion function *1
M	Fixed SI unit *2
P	With unit conversion function (psi initial value) *1

\*: A unit label is attached.

\*1: The new Measurement Law prohibits the use of pressure switch with the unit conversion function in Japan.

\*2: Unit ISE80H: MPa  
Others: MPa, kPa

Output specifications

Symbol	Content
N	NPN open collector 1 output
P	PNP open collector 1 output
A	NPN open collector 2 output
B	PNP open collector 2 output
R	NPN open collector 2 output + Analog voltage output/Auto-shift input
T	PNP open collector 2 output + Analog voltage output/Auto-shift input
S	NPN open collector 2 output + Analog current output/Auto-shift input
V	PNP open collector 2 output + Analog current output/Auto-shift input

## Accessories / Part numbers

Part number	Piping direction	Description
ZS-24-A	Rear piping	Bracket
ZS-24-D		
ZS-35-A	Bottom piping	Panel mount adapter
ZS-35-C	Rear piping	
ZS-35-B	Bottom piping	Panel mount adapter + Front protective cover
ZS-35-F	Rear piping	
ZS-35-E	Bottom piping	

## Summary of Product parts

### Names of individual parts

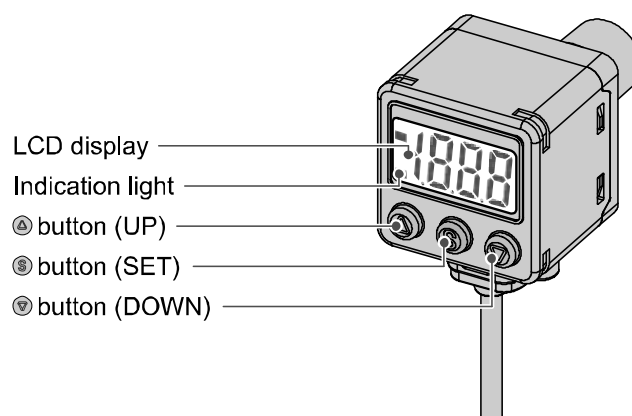

Indicator LED (Orange): Displays switch output condition.

LCD display: Displays the current status of pressure, setting mode, selected indication unit and error code.  
Four display modes can be selected: display always in red or green, or display changing from green to red, or red to green, according to the output status.

- ▲ button (UP): Selects the mode or increases the ON/OFF set value.  
Press this button to change to the peak display mode.
- ▼ button (DOWN): Selects the mode or decreases the ON/OFF set value.  
Press this button to change to the bottom display mode.
- Ⓢ button (SET): Press this button to change to another mode and to set a value.

## ■ Definition and terminology

	Terms	Meaning
2	2-colour display	2 colours are used to indicate a value, which change according to the output status.
7	7-segment display	When "8" is shown on the display. It is called 7-segment because 8 consists of 7 pieces of "-" (segments)".
A	Analogue current output	Refer to "Analogue output (function)".
	Analogue output function	A function to output the voltage or current in proportion to the pressure.
	Analogue voltage output	Refer to "Analogue output (function)".
	Auto preset	A function to automatically set up the pressure by having equipment hold and release a workpiece via vacuum adsorption. This function is used in an application where vacuum adsorption of a workpiece is confirmed by a Pressure switch.
	Auto shift	A function to correct the set value of the switch output in accordance with the applied pressure in case the switch operation is unstable due to pulsation of applied pressure. This function is used in applications such as vacuum adsorption. The pressure when a signal is externally input is set as a reference value with which the pressure that turns the switch on or off can be shifted.
B	Bottom value display	Indicates the minimum pressure reached up to that moment.
C	Chattering	The problem of the switch output turning ON and OFF repeatedly around the set value at high frequency due to the effect of pulsation.
	Chattering preventing function	A function to delay the response time of switch output in order to prevent chattering.
D	Digit (Minimum setting unit)	Shows how precisely the pressure can be indicated or set by the digital Pressure switch. When 1 digit = 1 kPa, the pressure is given with an increment of 1 kPa, e.g., 1, 2, 3, ..., 99, 100.
E	Error indication	With the self-diagnostic function of the Pressure switch, this indicates that there is an error which could cause a switch failure.
F	Fine adjustment mode	Refer to "Fine adjustment of display value".
	Fine adjustment of display value	A displayed pressure value can be adjusted within the range of $\pm 5\%$ R.D. ( $\pm 5\%$ of the displayed value). It is used if a true pressure value is known or to correct the difference of a displayed value of the measurement equipment nearby which measures the same pressure.
	F.S. (full span/full scale)	Abbreviation for full span or full scale; this means the maximum fluctuation range of the Pressure switch rated value. For example, when the output voltage is 1 to 5[V], the F.S. will be $5-1=4$ [V]. (Ref: $1\% \text{ F.S.} = 4 \times 0.01 = 0.04$ [V])
	Function selection mode	This is a mode in which each function is set up, and is a separate menu from the pressure setup. If the setting needs to be changed, "F*", each item can be set up. The items to be set up are: display colour, operation mode, output type, response time, display resolution, fine adjustment of indicated value, auto preset, power-saving mode and security code number.
H	Hysteresis	The difference between the pressure switch ON and OFF points, used to prevent chattering
	Hysteresis mode	Refer to "List of output modes" on page 26.

	Terms	Meaning
I	Indication accuracy	The deviation between displayed pressure value and the true pressure.
	Indication colour	The colour of the digital display. There are four choices: normally green, normally red, green (off) to red (on), and red (off) to green (on).
	Indicator LED	The LED that turns on when the switch output is on.
	Insulation resistance	Insulation resistance of the product itself. The resistance between an electrical circuit and the pressure switch body.
	Indication resolution	How fine the rated pressure range can be segmented. (Example: If a product for 0 to 1 MPa can indicate pressure by 0.001 MPa, the display resolution is 1/1000.)
	Indication unit	The unit of pressure used on the display.
	Internal voltage drop	Refer to "Residual voltage".
K	Key lock (function)	A function that locks the setting buttons so that no accidental setting changes can be made.
L	Load impedance	Refer to "Max. load impedance".
M	Manual setup	Manual pressure set up without using auto preset. This term is used to distinguish from the pressure set up using auto preset.
	Max. applied voltage	The maximum value of applied voltage available to the output wire of the NPN output.
	Max. load current	The maximum current available to the output wire of the switch output.
	Max. (Min.) load impedance	The maximum (minimum) load (resistance value and impedance) which can be connected to the output (output wire) of the analogue current output.
	Measurement mode	The condition in which the pressure is detected and displayed and the switch output is operating. (Refer to "Measurement mode" on page 19.)
	Min. setting unit	Refer to "digit".
N	Normal output	The switch output operation in which the switch is turned on when pressure equal to or greater than the set value is detected. In the (hysteresis mode) window comparator mode, it is the operation in which the switch is turned on when pressure is within the switch output range (P1L to P1H or P2L to P2H). (Refer to "List of output modes" on page 26).
	NPN (open collector) output	The switch output which uses the NPN transistor for output.
O	Operating mode	There are two choices, hysteresis mode and window comparator mode.
	Orifice	A restriction.
	Output impedance	The resistance value of a component between the voltage output element and the analogue voltage output. It is indicated as a resistance value which is converted in accordance with the condition in which resistance is directly connected to the voltage output element. There may be an error in the output voltage depending on this output impedance and the input impedance of customers' equipment. (example: If the Pressure switch with output impedance of 1 k $\Omega$ is connected to the A/D converter to detect the analogue output of 5 V, the detected voltage by the A/D converter becomes $5(V) \times 1(M\Omega)/(1(k\Omega) + 1(M\Omega)) \doteq 4.995(V)$ , and there is an error of approximate 0.005 V).
	Output type	The operation type of the switch output. Either normal output or reversed output can be selected. (Refer to "List of output modes" on page 26).

	Terms	Meaning
P	Peak value display	Displays the maximum pressure reached up to that moment.
	Piping-port size	The size of the port on the switch body with which a device can be connected.
	PNP (open collector) output	The switch output that uses the PNP transistor for output.
	Power saving mode	The condition in which the display is turned off to reduce current consumption.
	Pressure-sensing part	The pressure-detecting part of a pressure-detecting element.
	Pressure setting	The setting of pressure to determine the point at which the Pressure switch turns on and off.
	Proof pressure	The pressure beyond which the Pressure switch will be damaged.
R	Rated pressure range	The pressure range in which the Pressure switch meets the specifications. Values outside of this range can be set if they are within the set pressure range, but cannot be guaranteed to meet the product specifications.
	Repeatability	Reproducibility of the displayed value for pressure and ON-OFF output operating point when the pressure changes.
	Residual voltage	The difference between the ideal ON voltage and the actual voltage when the switch output is on. It depends on present load current and ideally should be "0"..
	Resolution	Refer to "Indication resolution".
	Response time	The elapsed time until the ON-OFF output begins operating, since the pressure supplied to the Pressure switch has reached the set value. Generally, the shorter the response time, the better the performance.
	Reversed output	The switch output operation in which the switch is turned on when pressure equal to or less than the set value is detected. In the (hysteresis mode) window comparator mode, it indicates the operation in which a switch is turned on when pressure is outside the switch output range (n1L to n1H or n2L to n2H). (Refer to "List of output modes" on page 26).
	Ripple	A type of chattering.
S	Sampling cycle	The frequency in which the detected pressure should be reflected to the digital display.
	Setting of function	Refer to "Function selection mode".
	Setting pressure range	The pressure range within which the switch output can be set.
	Stainless steel diaphragm	A stainless steel pressure-detecting part of the pressure-detecting element. It is suitable for measuring fluid such as water.
	Switch output	Alternatively called "ON-OFF output".
T	TSJ fitting	Abbreviation for Tube Swage Joint. The recommended fitting is Swagelok fitting made by Swagelok.
U	URJ fitting	Abbreviation for Union Ring Joint. The recommended fitting is VCR fitting made by Swagelok.
	Units selection function	Function to change the unit in which the value of pressure is displayed. Only a product with this function can change the unit. A product with Units selection function cannot be purchased if it is used within Japan. Pressure is indicated only by SI units in Japan.
W	Wetted part (or part exposed to fluid)	The part of the Pressure switch which is in contact with the detected fluid, such as a pressure sensor, seal, or fitting.
	Window comparator mode	An output type which holds the output when the pressure is within a certain range. (Refer to "List of output modes" on page 26).
	Withstand voltage	The ability to withstand a voltage applied between an electrical circuit and the body. If more voltage is applied to the product, the product may be damaged. (voltage mentioned here is not power voltage to activate the product).
Z	Zero clear function	The function which can adjust the displayed pressure value to "0".

## Mounting and Installation

### ■ Installation

#### ○ Mounting

- Mount the optional bracket and panel mount adapter to the Pressure switch.
- When the Pressure switch is to be mounted in a place where water and dust splashes occur, insert a tube (O.D  $\phi$ 4 mm, I.D  $\phi$ 2.5 mm) into the atmospheric vent port of the Pressure switch.

#### ○ Mounting with bracket

- Fix the bracket to the Pressure switch with the set screws M3 x 5 L (2 pcs.) supplied.
- The required tightening torque is 0.5 to 0.7 Nm.

<Rear piping>

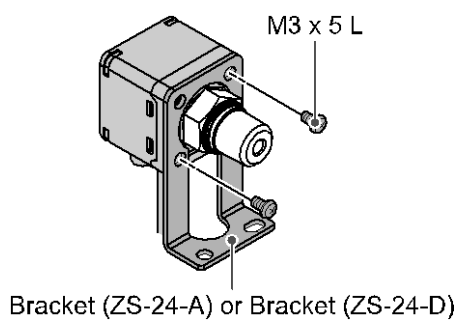

<Bottom piping>

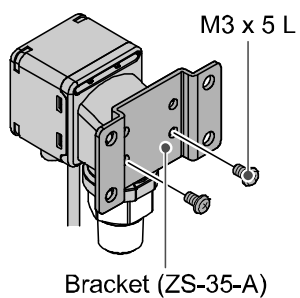

○Mounting with panel mount adapter  
<Rear piping>

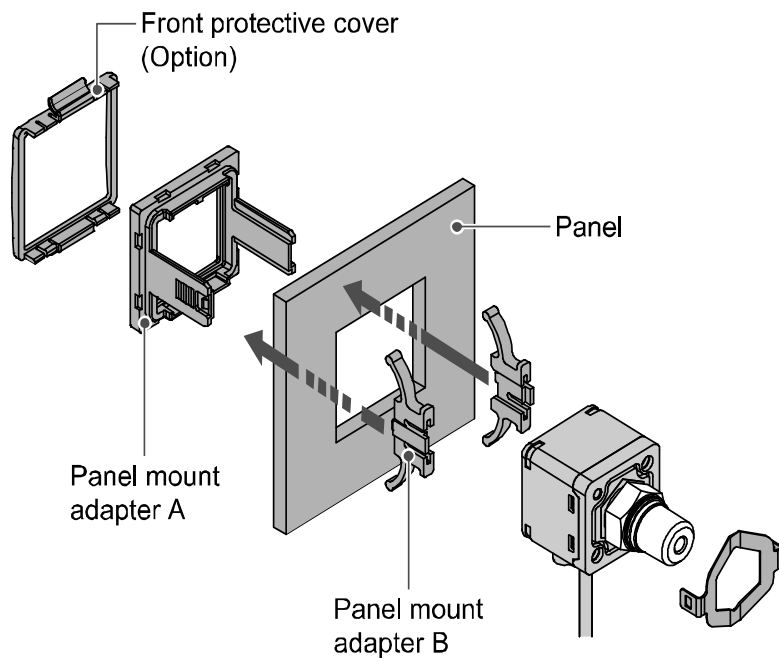

<Bottom piping>

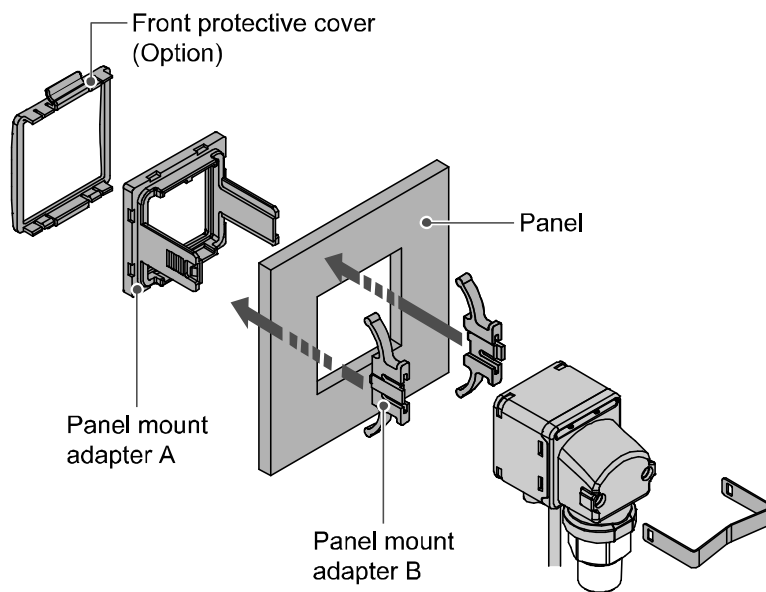



## ■ Piping

### ○ Connection using screw type piping

- Connect suitable piping to the port.
  - To connect the hexagon socket head plug or fitting to the pressure port, hold the hexagon part of the pressure port with a suitable spanner.
- The required tightening torque is 12 to 14 Nm.

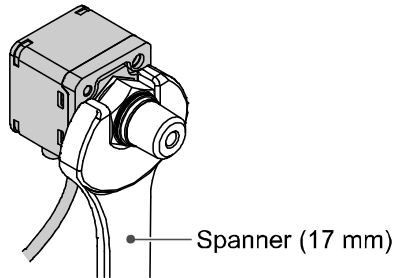

### ○ Tube attachment

- When the Pressure switch is used in a place where water and dust splashes may occur, insert a tube into the atmospheric vent port, and route the other end of the tube to a safe place away from water and dust. (refer to the figure below).

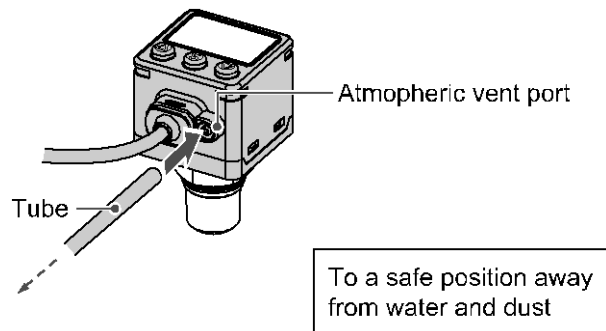

\*: Insert the tube into the atmospheric vent port until it bottoms out.

\*: SMC TU0425 (polyurethane, O.D  $\phi$ 4, I.D  $\phi$ 2.5) suits to the Pressure switch.

## ■Wiring

### ○Connection

- Connections should only be made with the power supply turned off.
- Use a separate route for the Pressure switch wiring and any power or high voltage wiring. Otherwise, malfunction may result due to noise.

### ○Internal circuit and wiring example

Z/ISE80-□-□-□□□□

● Output specification

#### -N

NPN open collector output type  
Max. 28 V, 80 mA  
Residual voltage 1 V or less

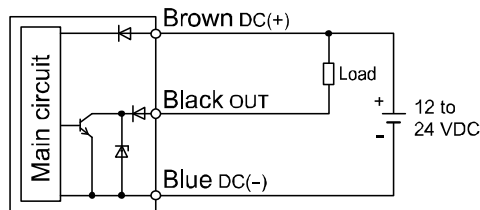

#### -P

PNP open collector output type  
Max. 80 mA  
Residual voltage 1 V or less

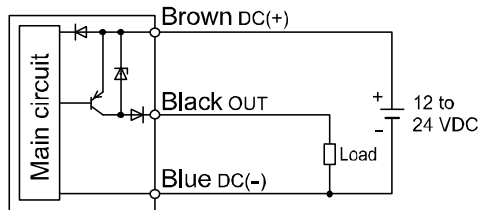

#### -S/-R

(Analogue output mode)

Switch output

NPN open collector output type 2 output

Max. 28 V, 8 mA

Residual voltage 1 V or less

R: Analogue output 1 to 5 V

Output impedance 1 kΩ

S: Analogue output 4 to 20 mA

Max. load impedance

Power supply voltage 12 V: 300 Ω

Power supply voltage 24 V: 600 Ω

Min. load impedance 50 Ω

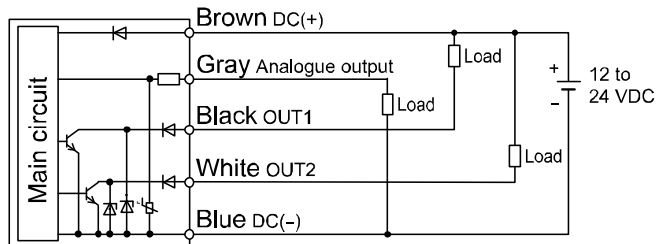

#### -S/-R

(Auto-shift input mode)

With auto-shift switch output

NPN open collector output type 2 output

Max. 28 V, 80 mA

Residual voltage 1 V or less

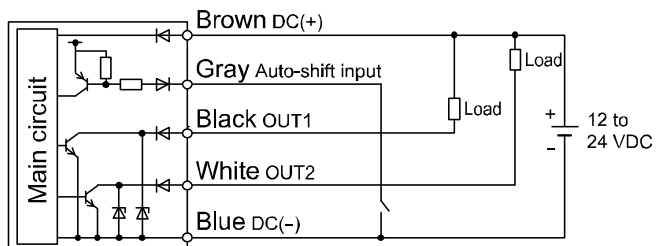

**-V/-T**

(Analogue output mode)

Switch output

PNP open collector output type 2 output

Max. 80 mA

Residual voltage 1 V or less

T: Analogue output 1 to 5 V

Output impedance 1 k $\Omega$

V: Analogue output 4 to 20 mA

Max. load impedance

Power supply voltage 12 V: 300  $\Omega$

Power supply voltage 24 V: 600  $\Omega$

Min. load impedance 50  $\Omega$

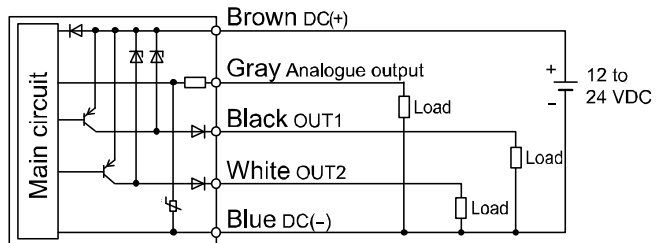

**-V/-T**

(Auto-shift input mode)

With auto-shift switch output

PNP open collector output type 2 output

Max. 80 mA

Residual voltage 1 V or less

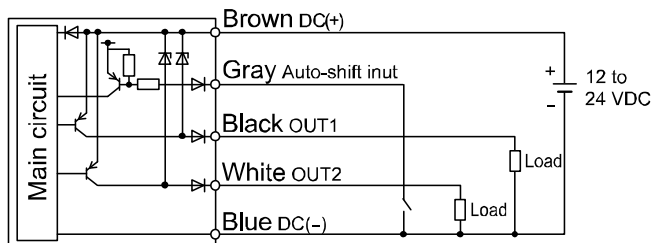

**-A**

NPN 2 output type

Max. 28 V, 80 mA

Residual voltage 1 V or less

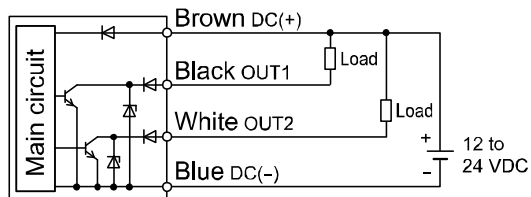

**-B**

PNP 2 output type

Max. 80 mA

Residual voltage 1 V or less

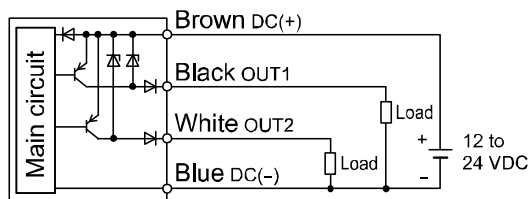

# Pressure Setting

## ■ Measurement mode

The measurement mode is the condition where the pressure is detected and displayed, and the switch function is operating.

This is the basic mode, and other modes should be selected for setting changes and other function settings.

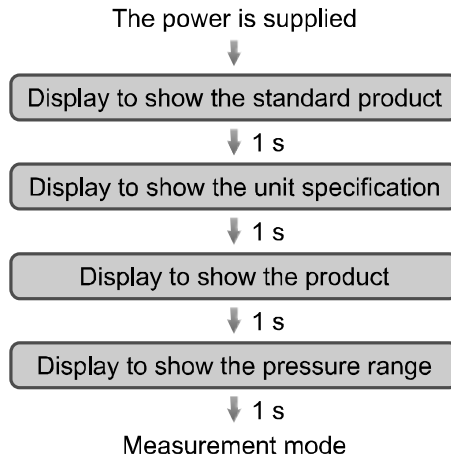

Setting the ON and OFF points of the Pressure switch.

### Operation (Hysteresis mode)

When the pressure exceeds a set point, the Pressure switch will be turned ON.

When the pressure falls below the set point by the amount of hysteresis or more, the Pressure switch will be turned OFF.

The default setting of the Pressure switch is adjusted to be turned on at the central value between atmospheric pressure and the upper limit of rated pressure range, and turned off when the pressure decreases by 5% of the span between atmospheric pressure and the upper limit of rated pressure range. (to change this setting, refer to page 20).

If this condition, shown below, is acceptable, then keep these settings.

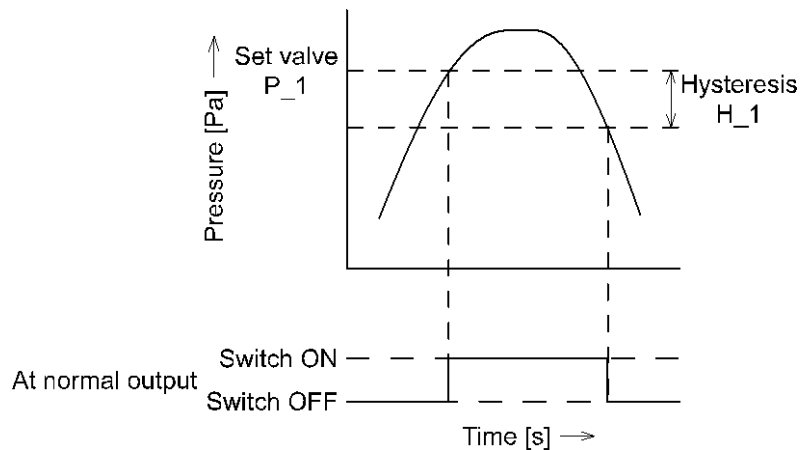

**<How to operate>** \*: The Pressure switch will also output during setting.

1, Press the  button once in measurement mode. (Page 19)



2, [P\_1] or [n\_1] and the set value are displayed in turn.



3, Press the  or  button to change the set value.

The  button is to increase and the  button is to decrease.

- Press the  button once to increase by one digit, and press it continuously to keep increasing the set value.

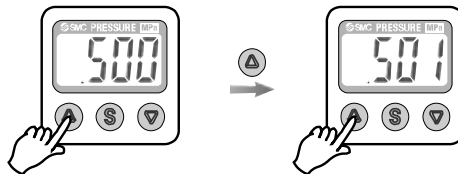

- Press the  button once to decrease by one digit, and press it continuously to keep decreasing the set value.

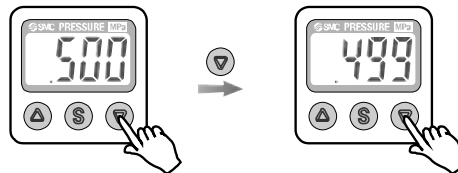



4, Press the  button to finish the setting.

For models with 2 outputs, [P\_2] or [n\_2] will be displayed. Set as above.

\*: If the  button is pressed for 2 seconds or longer, the setting is fixed and measurement mode returns.

The Pressure switch operates within a set pressure range (from P1L to P1H) during window comparator mode. Set P1L (switch lower limit) and P1H (switch upper limit) with the setting procedure above. (When reversed output is selected, [n1L] and [n1H] are displayed.) (to change to window comparator mode, refer to page 24).

#### Zero clear of Display

The display is reset to zero when the  and  buttons are pressed simultaneously for 1 second. For the first operation, always perform zero clear with no pressure applied.

## Function Setting

### ■ Function selection mode

In measurement mode, press the  button for 2 seconds or longer to display [F 0].

Select to display the function to be changed, [F□□].

Press the  button for 2 seconds or longer in function selection mode to return to measurement mode.

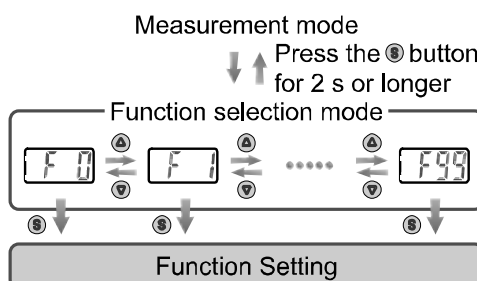

\*: Some functions are not available depending on part number. All functions are displayed with [F□□] followed by the function description. If a function is not available, the function is displayed as [- -].

### ■ Default setting

At the time of shipment, the following settings are provided.

If this condition is acceptable, then keep these settings.

To change the settings, enter function selection mode.

#### • [F 0] Units selection function Page 23

Symbol	Model	Default setting
Nil or M	ISE80(H)	MPa
	ZSE80(F)	kPa
P	ISE80(H)	psi
	ZSE80(F)	

#### • [F 1] Setting of OUT1 Page 24

Item	Description	Default setting
Output mode	Select hysteresis mode or window comparator mode.	Hysteresis mode
Reversed output	Select reversed output.	Normal output
Pressure setting	Set the ON or OFF point of the switch output.	ISE80: 0.500 MPa ZSE80: -50.5 kPa ZSE80F: 50.0 kPa ISE80H: 1.000 MPa
Hysteresis	Set the hysteresis to prevent chattering.	ISE80: 0.050 MPa ZSE80: 5.1 kPa ZSE80F: 5.0 kPa ISE80H: 0.100 MPa
Display colour	Select the display colour.	ON: Green OFF: Red

•[F 2] Setting of OUT2 ➡ Page 27

Same setting as [F 1] OUT1.

The display colour is linked to the setting of OUT1, and can not be set for OUT2.

•Other parameter settings

Item	Page	Default setting
[F 3] Response time	Page 27	2.5 ms
[F 4] Analogue output / Auto-shift input	Page 28	Analogue output
[F 5] Display resolution *	Page 30	1000-split
[F 7] Fine adjustment of display value	Page 31	0%
[F 8] Auto-preset function	Page 32	Manual
[F 9] Power saving mode	Page 34	OFF
[F10] Security code	Page 35	OFF
[F98] Setting of all functions	Page 36	OFF
[F99] Reset to the default setting	Page 38	OFF

\*: ISE80H cannot be set.

## ■ [F 0] Units selection function

Only the product with Units selection function can be set.

The displayed unit can be changed, and depends on the pressure range.

(Refer to the table below for the minimum indication unit).

(kPa/MPa units are available when the product does not have the units selection function.)

### <Operation>

Press the  $\Delta$  or  $\nabla$  button in function selection mode to display [F 0].

Press the  $\$$  button.  $\downarrow$  Move on to select the display unit.

#### Select the Display Unit

Press the  $\Delta$  or  $\nabla$  button to select the display unit.

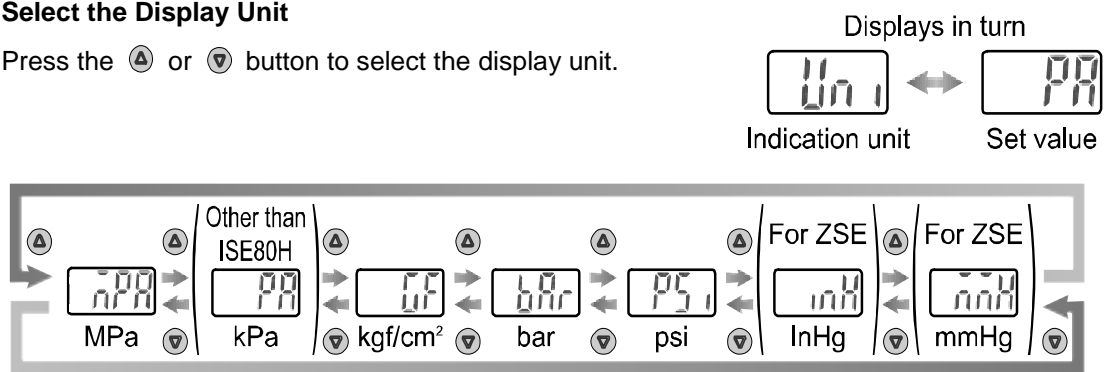

Press the  $\$$  button to set.  $\downarrow$  Return to function selection mode.

Setting of [F 0] Units selection function completed

### • Display unit and minimum setting unit

Unit	ZSE80F	ZSE80	ISE80	ISE80H
MPa	0.001	0.001	0.001	0.001 (to 1.999) 0.01 (2.00 to)
kPa	0.1	0.1	1	-
kgf/cm <sup>2</sup>	0.001	0.001	0.01	0.01 (to 19.99) 0.1 (20.0 to)
bar	0.001	0.001	0.01	0.01 (to 19.99) 0.1 (20.0 to)
psi	0.01	0.01	0.1	0.1 (to 199.9) 1 (200 to)
InHg	0.1	0.1	-	-
mmHg	1	1	-	-



## ■[F 1] Setting of OUT1

Set output method of OUT1.

The output turns on when the pressure exceeds the set value. The default setting of the output set value is the central value between the atmospheric pressure and the upper limit of the rated pressure range.

The display colour depends on the condition of OUT1.

The default setting of the display colour is as follows: green display when the output is ON and red display when the output is OFF.

For the operation of each setting, refer to "List of output modes" on page 26.

### <Operation>

Press the or button in function selection mode to display [F 1].

Press the button. Move on to setting output mode.

#### Select output mode

Press the or button to select output mode.

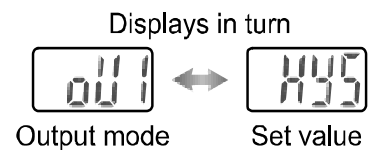
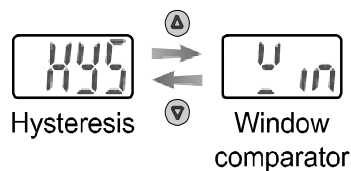

Press the button to set. Move on to setting of reversed output.

#### Select reversed output

Press the or button to select reversed output.

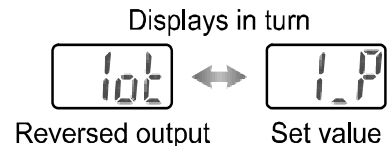
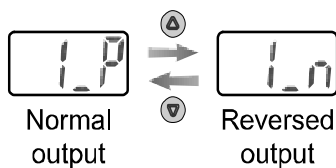

Press the button to set. Move on to setting of pressure.

#### Pressure Setting

Set the pressure based on the setting procedure on page 19.

"P" becomes "n" when reversed output is selected. ([P\_1] → [n\_1])

Hysteresis mode: [P\_1]

Window comparator mode: [P1L] [P1H]

Press the button to set. Move on to setting of hysteresis.



### Setting of hysteresis

Press the ▲ or ▼ button to select hysteresis.

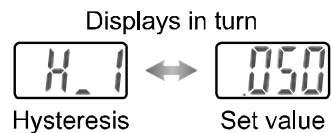

Press the Ⓢ button to set. ↓ Move on to setting of display colour.

### Setting of display colour

Press the ▲ or ▼ button to select display colour.

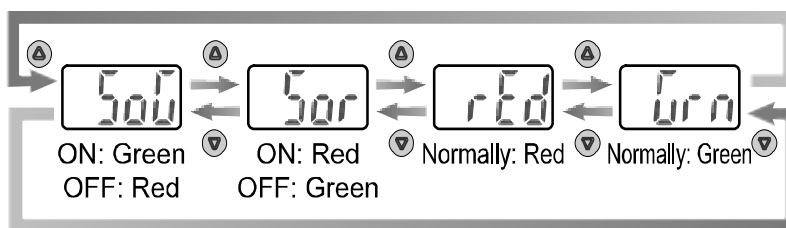
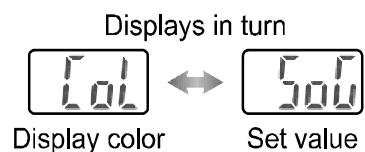

Press the Ⓢ button to set. ↓ Return to function selection mode.

Setting of [F 1] Setting of OUT1 completed

\*1: The selected parameter becomes effective after pressing the Ⓢ button.

\*2: After setting, it is possible to move to measurement mode by pressing the Ⓢ button again.

•List of output modes

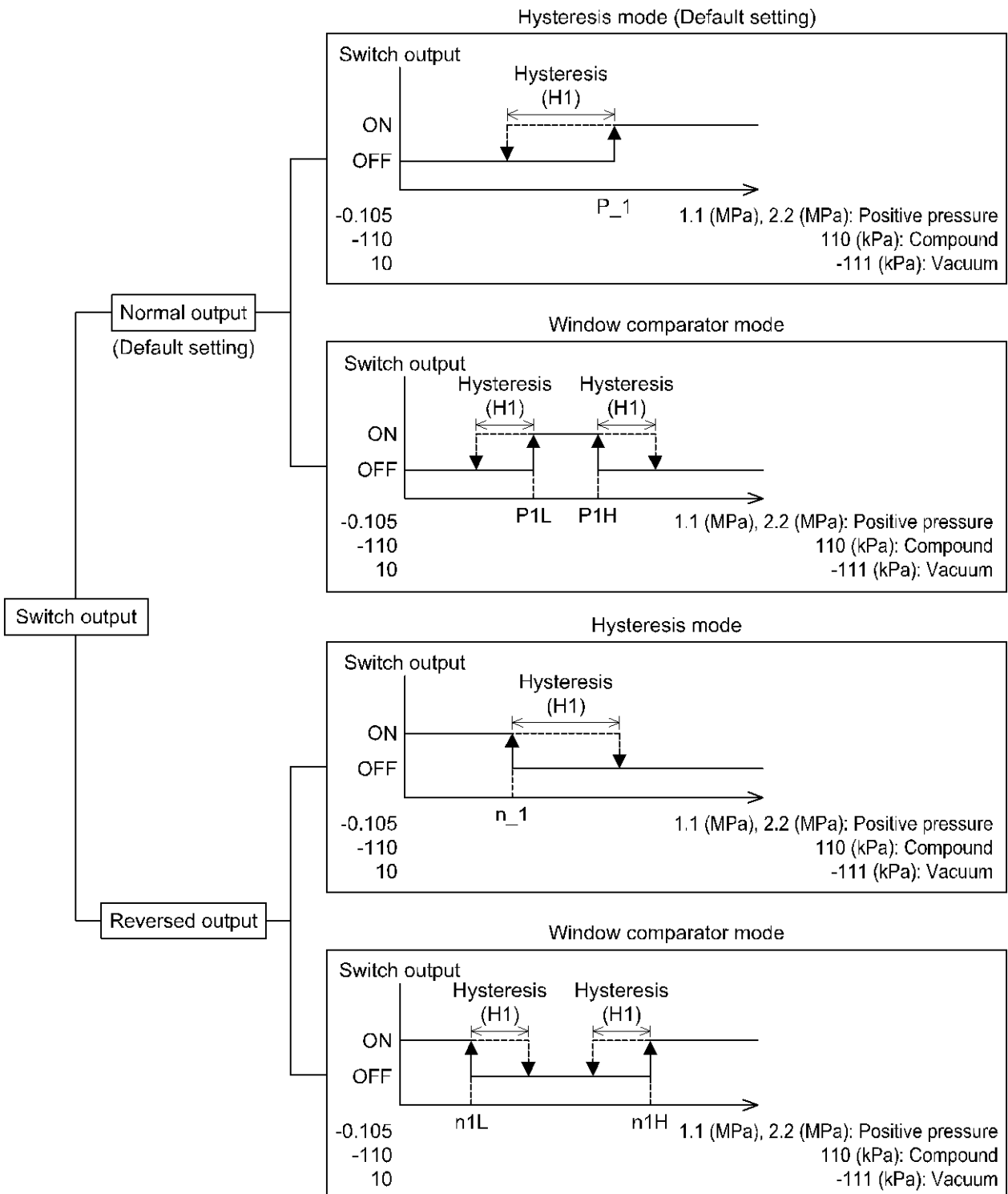

If the set point when the switch output is changed is outside the set pressure range due to switching between normal and reversed output, the hysteresis will automatically be compensated.

\*: The above figure shows the operation of OUT1.

For the operation of OUT2, "1" shown in the figure above becomes "2". (Ex)  $P_{-1} \rightarrow P_{-2}$

## ■[F 2] Setting of OUT2

Set output method of OUT2.

The display colour is linked to the setting of OUT1, and can not be set for OUT2

### <Operation>

Press the ▲ or ▼ button in function selection mode to display [F 2].

Press the Ⓢ button. ↓ Move on to setting output mode.

Set [F 2] based on [F 1] Setting of OUT1 (page 24 to 26).

## ■[F 3] Response time (chattering prevention function)

Select the response time of the switch output.

Output chattering can be prevented by setting the response time.

### <Operation>

Press the ▲ or ▼ button in function selection mode to display [F 3].

Press the Ⓢ button. ↓ Move on to setting of response time.

#### Setting of response time

Press the ▲ or ▼ button to select response time.

Displays in turn  
Response time ↔ Set value

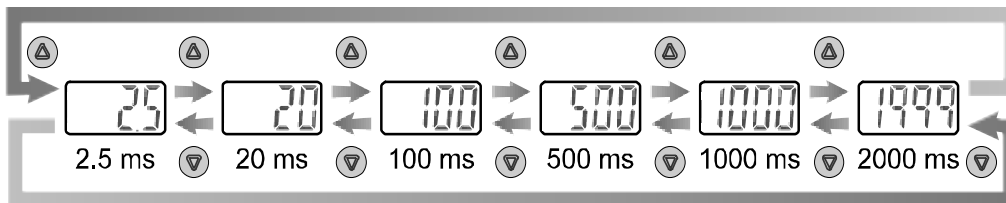

Press the Ⓢ button to set. ↓ Return to function selection mode.

Setting of [F 3] Response time completed

## ■[F 4] Analogue output / Auto-shift input

### Auto-shift function

This function is available when the analogue output / auto-shift input option has been selected.

Auto-shift: A function where the switch output is determined by the change in pressure, relative to a reference set value, when an external signal is input.

Auto-shift zero: A function where the switch output is determined by the change in pressure, relative to a reference set value, and the display reset to zero, when an external signal is input.

### <Operation>

Press the or button in function selection mode to display [F 4].

Press the button. Move on to setting of function.

#### Setting of function

Press the or button to select the function.

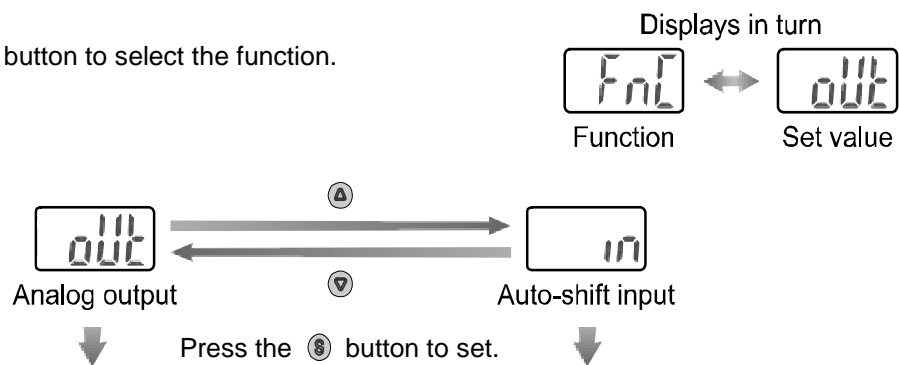

Move on to auto-shift function setting when auto-shift input is selected.

Return to function selection mode when analogue output is selected.

#### Setting of Auto-shift function

Press the or button to select auto-shift function.

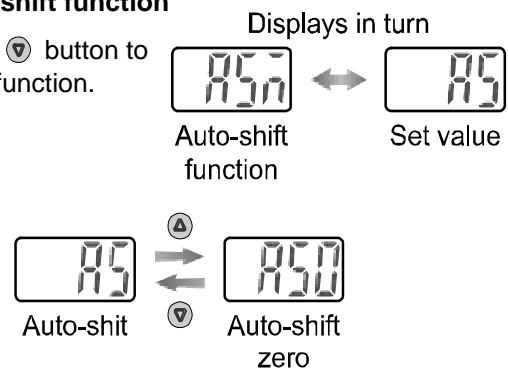

Press the button. Move on to setting of effective output.

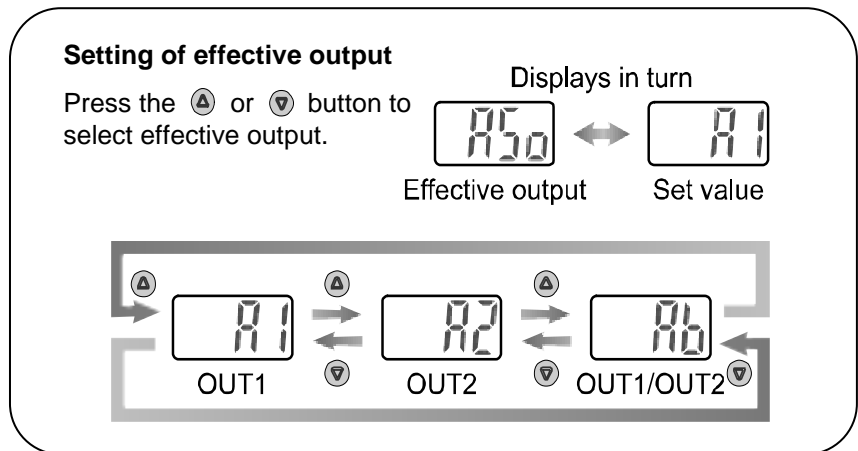

Press the Ⓢ button to set. ↓ Return to function selection mode.

Setting of [F 4] Analogue output/Auto-shift input completed

#### Conditions and explanations for auto-shift function

- Maintain a constant pressure for 5 ms or longer from the end of the auto-shift input signal.
- At auto-shift input, [000] is displayed for approximate 1 second. The measured pressure value at that time is stored as the corrected value [C\_5].
- With the corrected value stored, the set value is compensated.
- The switch output will start within 10 ms of the auto-shift input signal.
- If the measured pressure exceeds the set pressure range during auto-shift input signal, the corrected value will not be stored and [o.r] is displayed for approximately 1 second.
- If the pressure is within the set pressure range and beyond the set value corrected by auto-shift (including hysteresis) when the auto-shift input is applied, the set value is corrected to the upper limit or lower limit (whichever is closer) of the set pressure range automatically. (The correction is performed when the auto-shift input is applied at the pressure beyond the set pressure range. If the auto-shift input is applied again at the pressure within the set pressure range, the correction is released and the product operates according to the set value).
- After completing the pressure setting of OUT2, the corrected value and [C\_5] will be displayed in turn. Press the Ⓢ button to return to measurement mode.
- The corrected value [C\_5] after auto-shift input will disappear when the power is turned off, and will reset to zero (initial value) when the power is returned.

\*: The EEPROM is not used for the memory corrected value.

#### Using the Auto-shift input, the acceptable set range is as follows:

Range	Set pressure range	Accepted set range
Compound	-110.0 to 110.0 kPa	-220 to 220 kPa
1 MPa	-0.105 to 1.100 MPa	-1.205 to 1.205 MPa
2 MPa	-0.105 to 2.20 MPa	-2.31 to 2.31 MPa
Vacuum	10.0 to -111.0 kPa	-121.0 to 121.0 kPa



## ■[F 5] Display resolution

This function is used to change the pressure display resolution.



This can be used to prevent the digits from flickering on the display.

### <Operation>

Press the  or  button in function selection mode to display [F 5].

Press the  button.  Move on to setting of display resolution.

### Setting of display resolution

Press the  or  button to select display resolution.

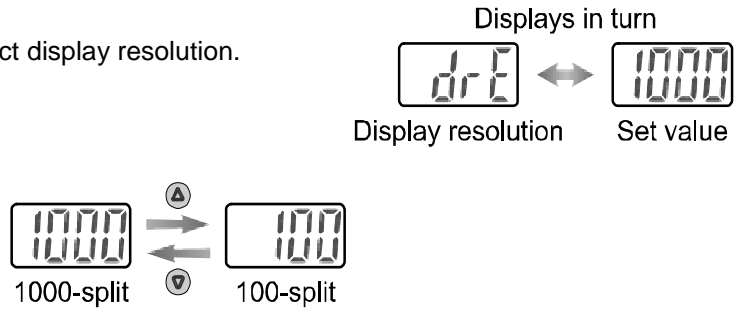

Press the  button to set.  Return to function selection mode.

Setting of [F 5] Display resolution completed

\*: ISE80H cannot be set.

Not selectable depending on the selected display units.

The display resolution selectable unit is MPa (only for ISE), kPa (only for ZSE), bar and psi.



(the units "bar" and "psi" are selectable only for models with the units selection function.



➡ [F 0] Units selection function on page 23.)

## ■[F 7] Fine adjustment of display value



This function is used to manually perform fine adjustment of the displayed pressure.  
It is adjustable within the range  $\pm 5\%$  R.D.

### <Operation>



Press the  or  button in function selection mode to display [F 7].

Press the  button.  Move on to setting of fine adjustment of display value.

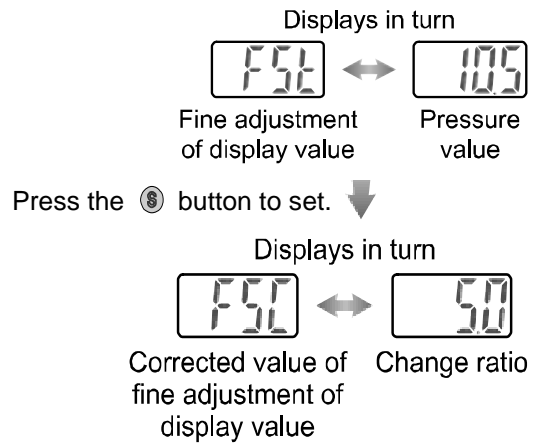

#### Setting of fine adjustment of display value

Press the  or  button to change the set pressure value.



Press the  button.  Move on to setting of adjustment initialize.

#### Setting of initializing of adjustment (to initialize the adjusted value)

Press the  or  button to select the initializing of adjustment.

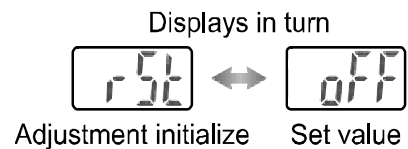
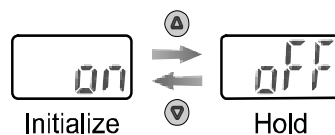

Press the  button.  Return to function selection mode.



Setting of [F 7] Fine adjustment of display value completed



## ■[F 8] Auto-preset function

When hysteresis mode is selected, the auto-preset function can calculate an optimum pressure value automatically based on the on-going operation.

### <Operation>

Press the  or  button in function selection mode to display [F 8].

Press the  button.  Move on to setting of auto-preset.

### Setting of Auto-preset

Press the  or  button to select auto-preset.

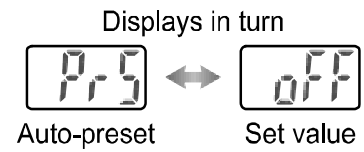
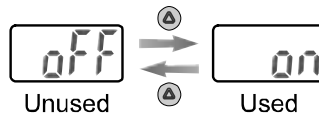

Press the  button to set.  Return to function selection mode.

Setting of [F 8] Auto-preset completed



Press the  button during measurement mode to set the pressure.

Then press the  button again to change the set pressure, while the display is flashing.

•Auto-preset

When auto-preset is selected in function selection mode, the set pressure can be calculated and stored from a measured pressure value. The set value is automatically optimized by repeated pressure changes to the Pressure switch.

1, Selection of auto-preset OUT1

Press the  button in measurement mode to display "AP1".  
(If OUT1 does not need to be set, press the  and  buttons simultaneously for 1 second or longer to move to "AP2").



Auto-preset is ready



2, Preparation of OUT1 device

Prepare the device for which the pressure of OUT1 is to be set.

3, Setting of auto-preset value of OUT1

Press the  button to display "A1L".



After measurement starts, operate the device and change the pressure. When the pressure change is detected, "A1H" will appear automatically, and so continue to operate the device.

(If the  and  buttons are pressed simultaneously for 1 second or longer while "A1L" is displayed, measurement is stopped and "AP2" will appear).



Auto-preset is being set



4, Selection of auto-preset OUT2

Press the  button to set "P\_1" and "H\_1" ("n\_1" and "H\_1" for reversed mode) and display "AP2".  
(If OUT2 does not need to be set, press the  and  buttons simultaneously for 1 second or longer return to measurement mode).

5, Preparation and setting of OUT2 device

Prepare the device for which the pressure of OUT2 is to be set, and perform the setting of OUT2 in the same way as for OUT1.

After "A2L" is displayed and measurements starts, the pressure change will be detected, and "A2H" will appear automatically.

(If the  and  buttons are pressed simultaneously for 1 second or longer when "A2L" is displayed, measurement is stopped and the display will return to measurement mode).

6, Completion of setting

Press the  button to set "P\_2" and "H\_2" ("n\_2" and "H\_2" for reversed mode) and complete auto-preset mode. After that, the display will return to measurement mode.

The set values for OUT1 are displayed in auto-preset mode as follows:

•Normal output

$$P_1 = A - (A - B)/4$$

$$H_1 = |(A - B)/2|$$

•Reversed output

$$n_1 = B + (A - B)/4$$

$$H_1 = |(A - B)/2|$$

A = Max. pressure

B = Min. pressure



The display of set values of OUT2 is changed at the number after "\_", i.e. "P\_2", "n\_2" and "H\_2".



## ■[F 9] Power saving mode

Power saving mode is selectable.

When the Pressure switch is left for 30 seconds with no key operation, it will enter power saving mode (the decimal point and indicator LED (only with the switch output ON) will flash during operation).



### <Operation>

Press the  or  button in function selection mode to display [F 9].

Press the  button.  Move on to setting of power saving mode.

### Setting of power saving mode

[ECo] and the set value are displayed in turn.

Press the  or  button to select power saving mode.

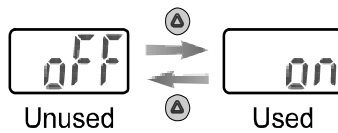
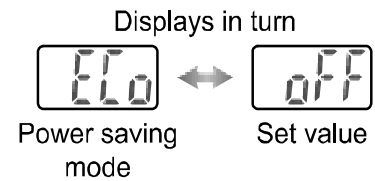

Press the  button to set.  Return to function selection mode.

Setting of [F 9] Power saving mode completed

In power saving mode, any key operation will return the normal display. If there is no key operation for 30 seconds, the display will return to power saving mode (only in measurement mode).

In power saving mode, only the decimal points and indicator LEDs will flash (the LEDs flash only when the switch is ON).

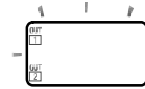



\*: The indicator LEDs will flash when the switch is ON, but it is not synchronized with the output.

## ■[F10] Security code

A security code can be selected, which must be entered to unlock the keys when the keys are locked.



### <Operation>

Press the  or  button in function selection mode to display [F10].

Press the  button.  Move on to setting of security code.

### Setting of security code

[Pin] and the set value are displayed in turn.

Press the  or  button to select security code.

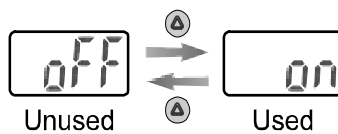
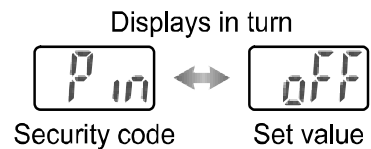

Press the  button to set.  Return to function selection mode.

Setting of [F10] Security code completed

If the security code is used, it becomes necessary to enter the security code to release the key lock.  
The security code can be decided optionally by the operator.  
The default setting is "000".

Refer to page 40 for the security code input.

■ Special function setting

■ [F98] Setting of all functions

All functions can be set, one after the other.

<Operation>

Press the ▲ or ▼ button in function selection mode to display [F98].

Press the Ⓢ button. ↓ Move on to setting of all functions.

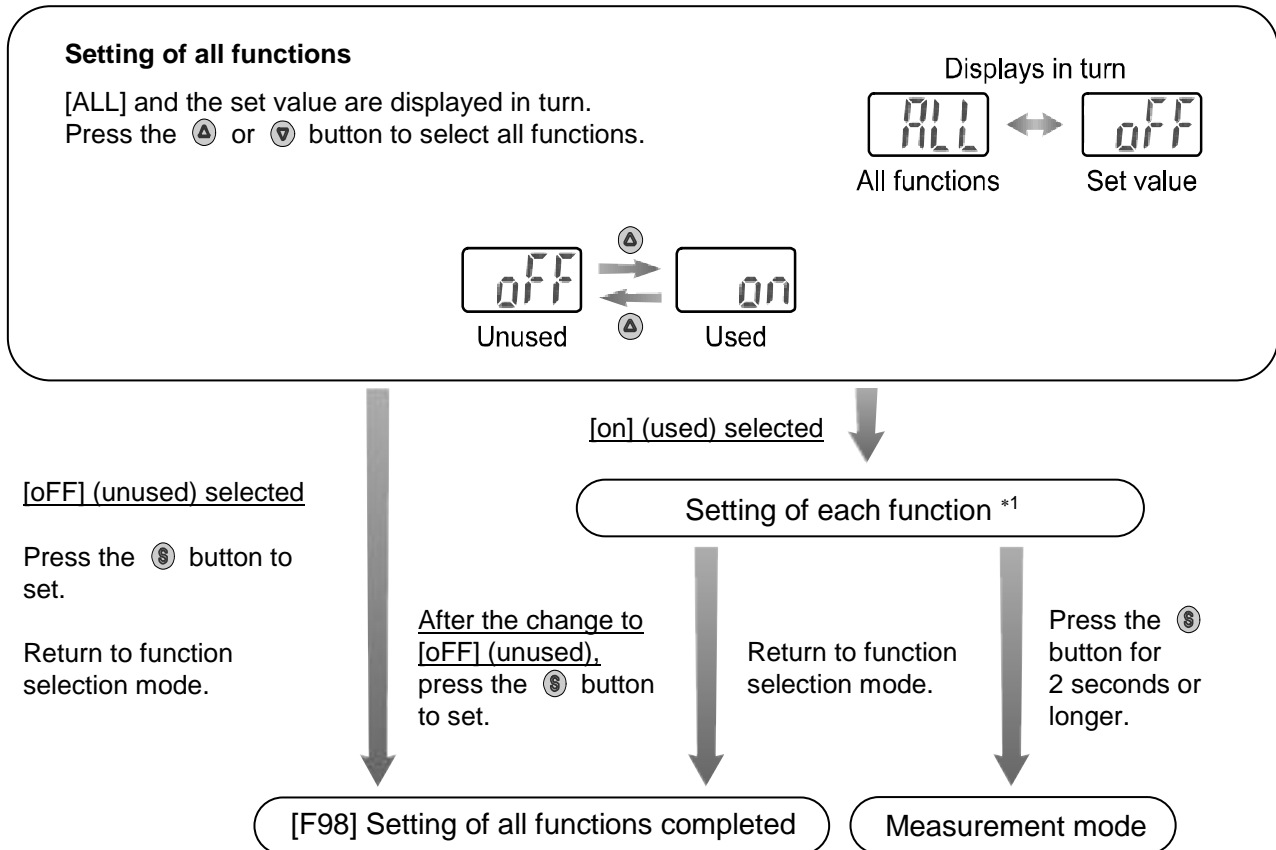

\*1: Setting of functions

Every time the Ⓢ button is pressed, the function steps in the "Order of Function setting" on page 37.

Set using the ▲ or ▼ buttons.

Refer to each section for further details of the setting.

•Order of function setting

Order	Function	Applicable model
1	Selection of display unit	Model with units selection function
2	Select output mode (OUT1)	All models
3	Select reversed output (OUT1)	All models
4	Setting of pressure (OUT1)	All models
5	Setting of hysteresis (OUT1)	All models
6	Setting of display colour	All models
7	Select output mode (OUT2)	Output for types other than N and P
8	Select reversed output (OUT2)	
9	Setting of pressure (OUT2)	
10	Setting of hysteresis (OUT2)	
11	Response time	All models
12	Grey wire function	Only for output types R, S, T, and V
13	Auto-shift function	
14	Effective output	
15	Display resolution	Other than ISE80H
16	Fine adjustment of display value	All models
17	Initialization of fine adjustment of display value	All models
18	Auto-preset	All models
19	Power saving mode	All models
20	Security code	All models

↓ Press the  button for 2 seconds or longer.

Measurement mode



\*: Measurement mode will return from any setting by pressing the  button for 2 seconds or longer.



\*: Function that will be set by the return to measurement mode.

## ■[F99] Reset to the default setting



If the setting of the pressure switch becomes unknown, the default setting can be restored.

### <Operation>

Press the  or  button in function selection mode to display [F99].

Press the  button.  Move on to reset to the default setting.

### Reset to the default setting

Set the display [ON] by pressing the  or  button, then press the  and  buttons simultaneously for 5 seconds or longer.

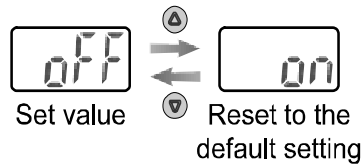
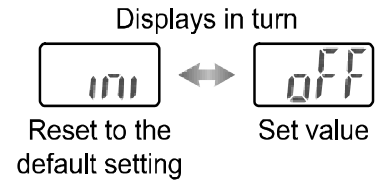

[oFF] (unused) selected

Press the  button to set

Return to function selection mode.

The setting is reset to the default setting, and the mode returns to the function selection mode.

Setting of [F99] Reset to the default setting completed

## Other Settings

### ○Peak/Bottom value display

The maximum (minimum) pressure from when the power was supplied to this moment is detected and updated.



In peak/bottom display mode, this pressure is displayed.

For peak display, when the  button is pressed for 1 second or longer, the maximum pressure and "Hi" starts flashing, and is held.

To release holding the display of the maximum pressure, press the  button for 1 second or longer again to return to measurement mode.



For bottom display, when the  button is pressed for 1 second or longer, the minimum pressure and "Lo" starts flashing and is held.

To release holding the display of the minimum pressure, press the  button for 1 second or longer again to return to measurement mode.

If the  and  buttons are pressed simultaneously for 1 second or longer while the pressure is being held, the maximum (minimum) values are reset.

### ○Zero Clear

The displayed value can be adjusted to zero when the measured pressure is within 10% of the span between atmospheric pressure and upper limit of rated pressure range, from the default value of pressure. (A tolerance range of  $\pm 1\%$  digit may apply due to individual product differences).

Press the  and  buttons simultaneously for 1 second or longer, to clear the display to "0".

The display will return to measurement mode automatically.

For analogue output, the analogue output will be changed along with the display.

### ○Key Lock

The key lock function is used to prevent errors occurring due to unintentional changes of the set values. If a button operation is performed while the key lock setting is ON, "LoC" is displayed for approximately 1 second.

The set value can be displayed by pressing the  button (It cannot be changed).



### <Operation - Without security code input- >

1, Press the  button for 5 seconds or longer in measurement mode.

The current setting "LoC" or "UnL" is displayed.

(selecting or releasing the key lock is carried out in a similar way).



2, Press the  or  button to select key lock (or key unlock).

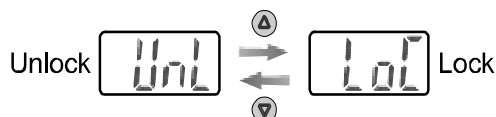

3, Press the  button to store the setting.



<Operation - With security code input- >

•Locking

- 1, Press the  button for 5 seconds or longer in measurement mode.  
The current setting “UnL” is displayed.

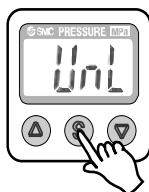

- 2, Press the  or  button to select keys lock “LoC”.

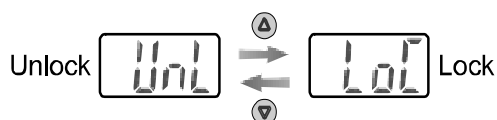

- 3, Press the  button to store the setting.

•Unlocking

- 1, Press the  button for 5 seconds or longer in measurement mode.  
The current setting “LoC” is displayed.



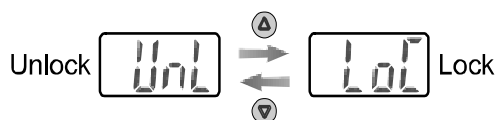

- 2, Press the  or  button to select keys unlock “UnL”.



- 3, When the  button is pressed, input of the security code will be requested.  
For how to enter the security code, refer to "How to enter the security code" on page 41.







- 4, If the security code entered is correct, the display will change to “UnL”. Press any of the ,  or  buttons to release the key lock and return to measurement mode.  
If the security code entered is incorrect, “FAL” will be displayed and the security code must be entered again. If an incorrect security code is entered three times, “LoC” is displayed and the display will return to measurement mode.

### •How to change the security code

At the time of shipment, the security code is set to “000”, but this can be changed to any number.



#### <Operation>

- 1, After the Key lock setting has been completed, perform the first three steps in the unlocking procedure (page 40).
- 2, After the security code has been entered and the display changes to “UnL”, press the  and  buttons simultaneously for 5 seconds or longer.  
“000” is displayed and a new security code can now be entered.  
For how to enter the security code, refer to “How to enter the security code”.  
The new security code will be displayed.
- 3, After checking the security code is as required, press the  button for 1 second or longer.  
The display will return to measurement mode.  
At this time, if the  or  button is pressed, any security code changes are lost, and the change of security code procedure must be repeated.





#### •How to enter the security code

The first digit will start flashing.

Press the  or  button to select a value.

Press the  button to set and the next digit will start flashing.

(If the  button is pressed at the last digit, the first digit will start flashing again).

After the setting is completed, press the  button for 1 second or longer.

(If a key operation is not performed for 30 seconds, while entering the security code, the measurement mode will return).

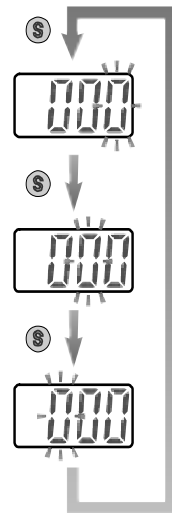

## Maintenance

How to reset the product after a power cut or forcible de-energizing

The setting of the product will remain as it was before a power cut or de-energizing.

The output condition is also basically recovered to that before a power cut or de-energizing, but may change depending on the operating environment.

Therefore, check the safety of whole installation before operating the product.

If the installation is using accurate control, wait until the product has warmed up (approximately 10 to 15 minutes).

## If the security code is forgotten



The following procedure can be used when the security code has been forgotten.



### <Operation>

Press the  button for 5 seconds or longer in measurement mode.

The current setting "UnL" or "LoC" is displayed.





Press the  and  buttons simultaneously for 5 seconds or longer.

Then, press the  and  buttons simultaneously for 5 seconds or longer.

\*: There will be no change to the display.

(at this time, if another operation is performed or no key operation is performed for 30 seconds, the display will return to measurement mode).



Press the  and  buttons simultaneously for 5 seconds or longer. The display will change to "000" and the security code change mode will return.

Refer to "How to enter the security code" (page 41) and select a new security code.

The new security code will be displayed.

Check the security code is as required, and press the  button for 1 second or longer.

The display will return to measurement mode.

At this time, if the  or  button is pressed, any security code changes will be lost, and the change of security code procedure must be repeated.



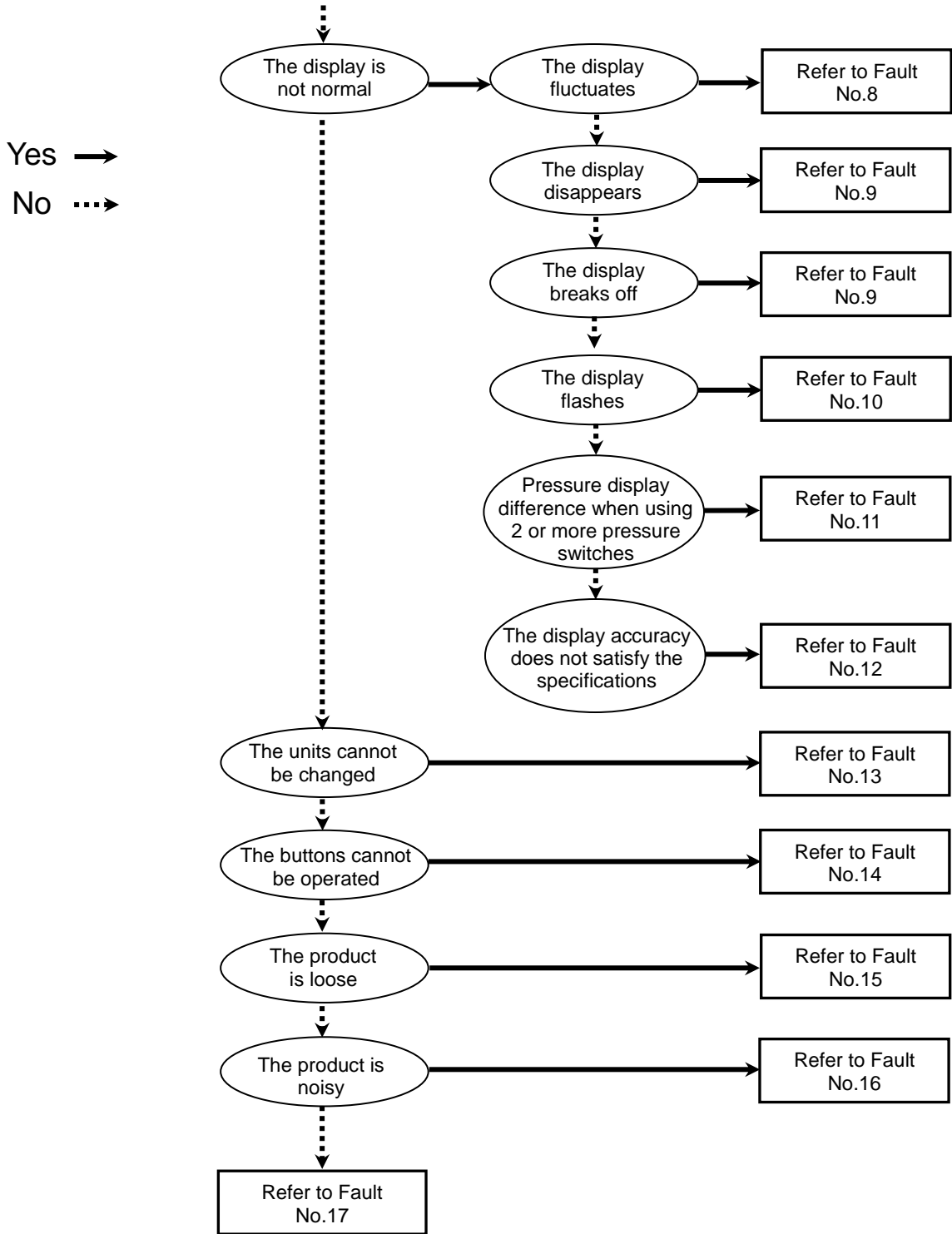

○Faults and countermeasures

Fault No.	Fault	Possible cause	Investigation method	Countermeasure
1	<ul style="list-style-type: none"> <li>●Output remains ON. Indicator LED remains ON.</li> <li>●Output remains OFF. Indicator LED remains OFF.</li> </ul>	Incorrect pressure setting	(1) Check the set pressure. (2) Check the operation mode, hysteresis and output type. (hysteresis mode / window comparator mode, normal / reversed output)	(1) Reset the pressure setting. (2) Reset the function settings.
		Product failure		Replace the product.
2	Output remains ON. Indicator LED works correctly.	Incorrect wiring	Check the wiring of the output line. Check if the load is connected directly to DC(+) or DC(-).	Correct the wiring.
		Product failure		Replace the product.
3	Output remains OFF. Indicator LED works correctly.	Incorrect wiring	Check the wiring of the output line. Check if the load is connected directly to DC(+) or DC(-).	Correct the wiring.
		Unsuitable model selection	Check if PNP is used when NPN should have been selected, or the other way around.	Review the selected model (output type).
		Broken lead wire	Check if there is bending stress applied to any parts of the lead wire. (bending radius and tensile force applied).	Correct the wiring conditions. (adjust the tensile force and increase the bending radius).
		Product failure		Replace the product.
4	Switch output generates chattering.	Incorrect wiring	Check the wiring. Check that the brown and blue wires are connected to DC(+) and DC(-) respectively, and if the output wiring is loose (contact failure).	Correct the wiring.
		Incorrect settings	(1) Check the set pressure. (2) Check that the hysteresis range is not too narrow. (3) Check the response time set at initial setting. Check that the response time is not too short.	(1) Reset the pressure setting. (2) Increase the hysteresis. (3) Reset the function settings.
		Product failure		Replace the product.
5	Slow switch output response	Incorrect pressure setting	Check the pressure setting. Check that the detected pressure and the set pressure value are not the same or not too close.	Reset the pressure setting. Set the pressure setting value so it is not too close to the detected pressure.

Fault No.	Fault	Possible cause	Investigation method	Countermeasure
6	Analogue output is not provided. (specified accuracy is not satisfied.)	Incorrect wiring	Check that the analogue output is connected to a load.	Correct the wiring.
		Non-compliance with the load specification	(1) Check that the correct load is connected. (2) Check that the impedance of the input equipment (A/D transformer) is suitable.	Connect a suitable load.
		Insufficient warm-up time	Check if the product satisfies the specified accuracy after 10 minutes warm up time.	After energizing, the display and output can drift. For detecting fine pressures, warm up the product for 10 to 15 minutes.
		Product failure		Replace the product.
7	<ul style="list-style-type: none"> <li>•An over current error (Er1, Er2) is displayed.</li> <li>•System error (Er0, Er4, Er6 or Er7) is displayed.</li> <li>•The display shows "HHH".</li> <li>•The display shows "LLL".</li> <li>•Residual pressure error (Er3) is displayed.</li> </ul>	Over current to the output (Er1, Er2)	(1) Check that the switch output load current is not more than 80 mA. (2) Check that the connected load satisfies the specifications, and check the load for short circuits. (3) Check that any relay is connected with a surge voltage suppressor. (4) Check if the wiring is not in the same route as (or bundled together with) a high voltage cable or power cable.	(1), (2) Connect the load as specified. (3) Use a relay with a surge voltage suppressor or take measures to prevent noise. (4) Separate the wiring route from any high voltage cable or power cable.
		Incorrect operation of the internal data of the Pressure switch (Er0, Er4, Er6,Er7)	(1) Check that there is no noise interference such as static electricity, and check for noise sources. (2) Check that the power supply voltage is within the range 12 to 24 VDC $\pm 10\%$ .	(1) Remove the noise and the noise source (or take measures to prevent noise interference), and reset the product, or turn off the power supply and turn it on again. (2) Supply a correct voltage of 12 to 24 VDC $\pm 10\%$ .
		Applied pressure is over the upper limit (HHH).	(1) Check that the pressure is not above the upper limit of the set pressure range. (2) Check that foreign matter has not entered the piping.	(1) Adjust the pressure within the set pressure range. (2) Take measures to prevent foreign matter from entering the piping.
		Applied pressure is under the lower limit (LLL).	(1) Check that the pressure is not below the lower limit of the set pressure range. (2) Check that foreign matter has not entered the piping.	(1) Adjust the pressure within the set pressure range. (2) Take measures to prevent foreign matter from entering the piping.
		Pressure is not atmospheric pressure at zero-clear operation (Er3)	Check that during the zero clear operation, pressure above $\pm 10\%$ F.S. (from atmospheric pressure to the upper limit of rated pressure) of atmospheric pressure was not applied.	Return the applied pressure to atmospheric pressure, and retry the zero clear operation.
		Product failure		Replace the product.

Fault No.	Fault	Possible cause	Investigation method	Countermeasure
8	Displayed value fluctuates.	Incorrect power supply	Check if the power supply voltage is within the range of 12 to 24 VDC $\pm 10\%$ .	Supply the correct voltage of 12 to 24 VDC $\pm 10\%$ .
		Incorrect wiring	Check the wiring to the power supply. Check if the brown and blue wires are connected to DC(+) and DC(-) respectively and if the output line is about to come off (contact failure).	Correct the wiring.
		Factory pressure change	Check if the factory pressure has changed.	If the fluctuation is not acceptable, the pressure switch display resolution can be changed.
9	<ul style="list-style-type: none"> <li>•Display turns OFF.</li> <li>•Part of the display is missing.</li> </ul>	Incorrect power supply	Check that the power supply voltage is within the range of 12 to 24 VDC $\pm 10\%$ .	Supply the correct voltage of 12 to 24 VDC $\pm 10\%$ .
		Power saving mode	Check if the power saving mode is selected.	Reset the function settings.
		Incorrect wiring	Check the power supply wiring. Check that the brown and blue wires are connected to DC(+) and DC(-) respectively and that the output wiring is not loose (contact failure).	Correct the wiring.
		Product failure		Replace the product.
10	Display is flashing.	The peak / bottom value display mode is selected.	Check if the peak value or bottom value display mode has been selected.	Turn off the peak / bottom value display mode if not required.
		Wiring failure	(1) Check the power supply wiring. (2) Check if there is bending stress applied to any parts of the lead wire.	(1) Correct the wiring (2) Correct the wiring conditions (reduce the tensile force and increase the bending radius).
11	Pressure display difference when using 2 or more Pressure switches.	Dispersion within the display accuracy range	Check if the dispersion is within the display accuracy range.	Use the fine adjustment mode to adjust the display if the dispersion is within the display accuracy range.
		Product failure		Replace the product.



Fault No.	Fault	Possible cause	Investigation method	Countermeasure
12	The pressure display accuracy does not satisfy the specifications.	Foreign matter	Check if any foreign matter has entered the pressure port.	Install a 5 μm filter to prevent foreign matter from entering the pressure port. Also, clean the filter regularly to prevent drainage deposits.
		Air and fluid leakage	Check if air or fluid are leaking from the piping.	Rework the piping. If an excessive tightening torque is applied, the mounting bracket, screws or the product may be damaged.
		Insufficient warm-up time	Check if the product satisfies the specified accuracy after 10 minutes warm up time.	After energizing, the display and output can drift. For detecting fine pressures, warm up the product for 10 to 15 minutes.
		Product failure		Replace the product.
13	The display units cannot be changed.	Improper model selection (selection of model "without units selection function")	Check if there is an "-M" at the end of the part number printed on the product	"M" in the part number means that the units cannot be changed. (kPa↔MPa can be selected) *: The units selection function is not available in Japan due to a new measurement law. *: It is fixed to the SI unit "kPa", "MPa".
		Product failure		Replace the product.
14	The buttons cannot be operated.	Key lock mode	Check if the key lock mode is turned on.	Turn off the key lock mode.
		Product failure		Replace the product.
15	The product is loose.	Incorrect installation	Check that the panel mount adapter and the product are correctly assembled.	Mount the product on the panel correctly.
		Product failure		Replace the product.
16	The product is noisy.	Air or fluid leakage	Check if air or fluid are leaking from the piping.	Rework the piping. If an excessive tightening torque is applied, the mounting bracket, screws or the product may be damaged.
		Product failure		Replace the product.
17	The operation is unstable. (chattering)	Pressure source fluctuation, small hysteresis or the response time is too short.	(1) Check the set pressure (hysteresis) (2) Check the response time	(1) Check the pressure setting. (2) Reset the function settings.
		Incorrect wiring or broken lead wire	(1) Check the power supply wiring. (2) Check if there is bending stress applied to any parts of the lead wire.	(1) Correct the wiring conditions (reduce the tensile force and increase the bending radius). (2) Correct the wiring conditions (reduce the tensile force and increase the bending radius).
		Product failure		Replace the product.

○Error indication

This function is to display error location and content when a problem or an error occurs.

Error Name	Error Display	Error Type	Troubleshooting Method
Over current Error	Er1 Er2	The switch output load current is more than 80 mA.	Turn the power off and remove the cause of the over current. Then turn the power on.
Residual Pressure Error	Er3	During zero clear operation, pressure above $\pm 10\%$ of the span between atmospheric pressure and upper limit of rated pressure has been applied. After 1 second, the mode will return to measurement mode. The zero clear range can vary $\pm 1$ digit with individual product differences.	Perform zero clear operation again after restoring the applied pressure to an atmospheric pressure condition.
Pressurizing Error	HHH	Pressure has exceeded the upper limit of the set pressure range.	Reset applied pressure to a level within the set pressure range.
	LLL	Pressure has exceeded the lower limit of the set pressure range.	
Auto-shift Error	OF	The measured pressure at auto-shift input exceeded the set pressure range. *: After 1 second, measurement mode will return automatically.	Auto-shift input signal is invalid. Check the connected equipment and correct the signal.
System Error	Er4 Er6 Er7 Er0	Displayed in the case of an internal data error.	Turn the power off and turn it on again. If resetting fails, an investigation by SMC Corporation will be required.

If the error can not be reset after the above measures are taken, then please contact SMC.

# Specification

## ■ Specifications

Model No.	ISE80 (positive pressure)	ISE80H (positive pressure)	ZSE80 (vacuum)	ZSE80F (compound)	
Rated pressure range	-0.1 to 1 MPa	-0.1 to 2 MPa	0 to -101 kPa	-100 to 100 kPa	
Set pressure range	-0.105 to 1.1 MPa	-0.105 to 2.2 MPa	10 to -111 kPa	-110 to 110 kPa	
Withstand pressure	2 MPa	4 MPa	500 kPa		
Setting and display resolution	0.001 MPa	0.001 MPa (1.999 MPa) 0.01 MPa (2.00 to 2.20 MPa)	0.1 kPa		
Port material	Pressure sensor: SUS630, Fitting: SUS304				
Fluid	Fluid which has no corrosive effect on SUS630, SUS304				
Connection port	R1/4, NPT1/4, G1/4, URJ1/4, TSJ1/4, Rc1/8 Piping direction: Rear or Bottom				
Power supply voltage	12 to 24 VDC $\pm 10\%$ with voltage ripple or less				
Current consumption	45 mA or less				
Protection	Protected against reverse connection				
Switch output	NPN1 output, NPN2 output, PNP1 output, PNP2 output				
	Max. load current	80 mA			
	Max. applied voltage	28 V (NPN output)			
	Residual voltage	1 V or less (80 mA load current)			
	Response time	2.5 ms (with anti-chatter function: 20, 100, 500, 1000, 2000 ms selectable)			
	Short circuit protection	Provided			
Repeatability	$\pm 0.2\%$ F.S. $\pm 1$ digit				
Hysteresis	Hysteresis mode	0 to variable *1			
	Window comparator mode				
Analogue output	Voltage output *2	Output voltage	0.6 to 5 V $\pm 2.5\%$ F.S. Linearity: $\pm 1\%$ F.S.	0.8 to 5V $\pm 2.5\%$ F.S. Linearity: $\pm 1\%$ F.S.	1 to 5V $\pm 2.5\%$ F.S. Linearity: $\pm 1\%$ F.S.
		Output impedance	Approx. 1 k $\Omega$		
	Current output *3	Output current	2.4 to 20 mA $\pm 2.5\%$ F.S. Linearity: $\pm 1\%$ F.S.	3.2 to 20 mA $\pm 2.5\%$ F.S. Linearity: $\pm 1\%$ F.S.	4 to 20 mA $\pm 2.5\%$ F.S. Linearity: $\pm 1\%$ F.S.
		Load impedance	Max. load impedance: 300 $\Omega$ (power supply voltage of 12 V) : 600 $\Omega$ (power supply voltage of 24 V) Min. load impedance: 50 $\Omega$		
Auto shift input	Non-voltage input (reed or solid state), Low level 0.4 V or less, input times 5 ms or more				
Display	3 1/2 digits, 7-segment display, dual-colour display (red/green)				
Display accuracy	$\pm 2\%$ F.S. $\pm 1$ digit (ambient temperature 25 $\pm 3$ $^{\circ}\text{C}$ )				
Indicator LED	OUT1/OUT2: ON when LED is ON (Orange)				
Functions	Anti-chatter function, Zero clear, Key lock, Auto pre-set, Display unit selection, Power saving mode, Auto shift				

\*1: If the applied voltage fluctuates around the set value, the hysteresis must be set to more than the fluctuation width. Otherwise, chattering will occur.

\*2: If analogue voltage output is selected, the analogue current output cannot be selected.

\*3: If analogue current output is selected, the analogue voltage output cannot be selected.

Model No.		ISE80 (positive pressure)	ISE80H (positive pressure)	ZSE80 (vacuum)	ZSE80F (compound)
Environment	Enclosure	IP65			
	Ambient temperature	Operation: 0 to 50 °C, Storage: -10 to 60 °C (No condensation or freezing)			
	Ambient humidity	Operation, Storage: 35 to 85% RH (No condensation)			
	Withstand voltage	250 VAC for 1 minute Between wires and case			
	Insulation resistance	2 MΩ or more (50 VDC by megameter) Between wires and case			
Temperature characteristic		±3% F.S. (25 °C Ambient temperature range))			
Lead wire		Oil resistant vinyl cabtyre cable 3 cores (N.P) φ3.5, 2 m 4 cores (A.B) Sectional area of conductor: 0.15 mm <sup>2</sup> (AWG26) 5 cores (R.T.S.V) Outside diameter of insulator: 0.95 mm			
Standard		CE marked (EMC directive/RoHS directive), UL/CSA			

○Piping specifications

Model No.	O2	N02	F02	C01	A2	B2
Port size	R1/4	NPT1/4	G1/4	Rc1/8	URJ1/4	TSJ1/4
Mass (Bottom ported)	117 g	118 g	-	114 g	120 g	111 g
Mass (Rear ported)	89 g	90 g	86 g	86 g	92 g	83 g
Leakage	1x10 <sup>-5</sup> Pa•m <sup>3</sup> /s			1x10 <sup>-10</sup> Pa•m <sup>3</sup> /s		

○Analogue output

Voltage output

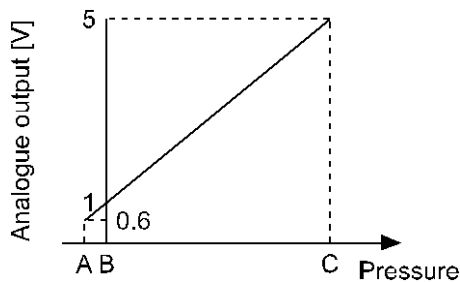

Current output

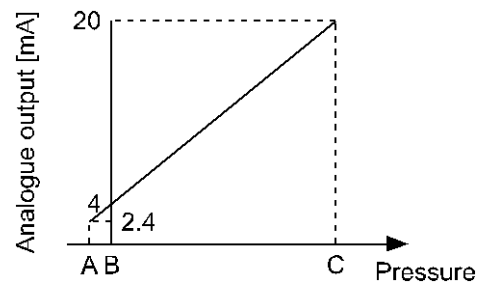

Range	Rated pressure range	A	B	C
Vacuum	0.0 to -101.0 kPa	-	0	-101.0 kPa
Compound	-100.0 to 100.0 kPa	-	-100 kPa	100 kPa
Positive pressure	-0.100 to 1.000 MPa	-0.1 MPa	0	1 MPa
	-0.100 to 2.00 MPa	-0.1 MPa *	0	2 Mpa

\*: Analogue output is 0.8 [V] or 3.2 [mA] at the pressure A.

## ■Dimensions

●Z/ISE80(F)-02/N02/F02/C01/A2/B2/-\*

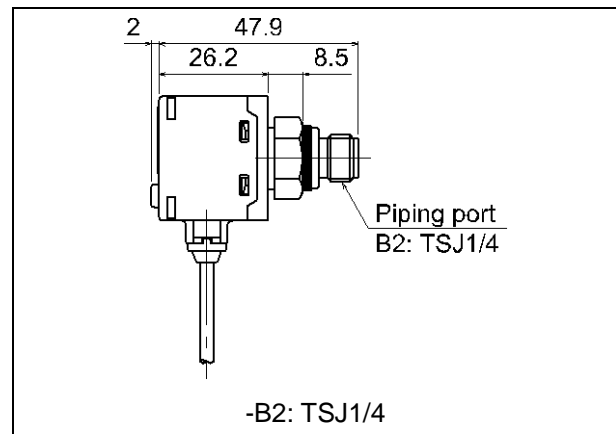
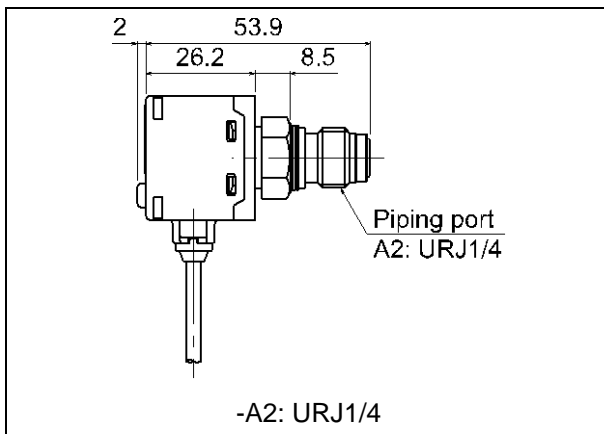
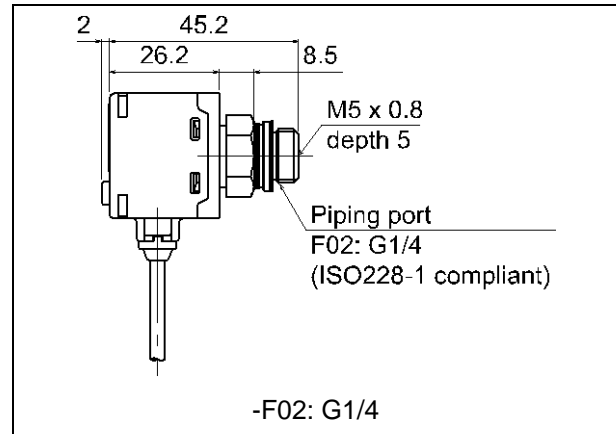
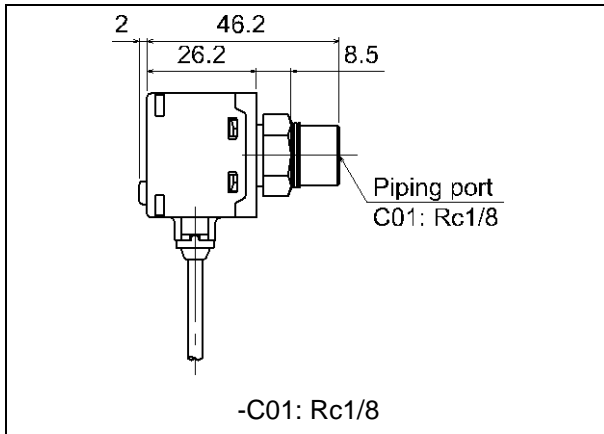
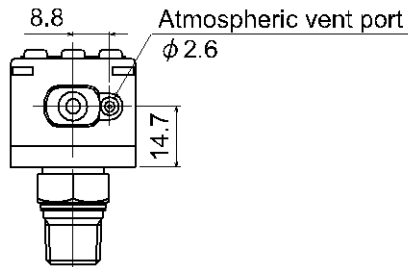
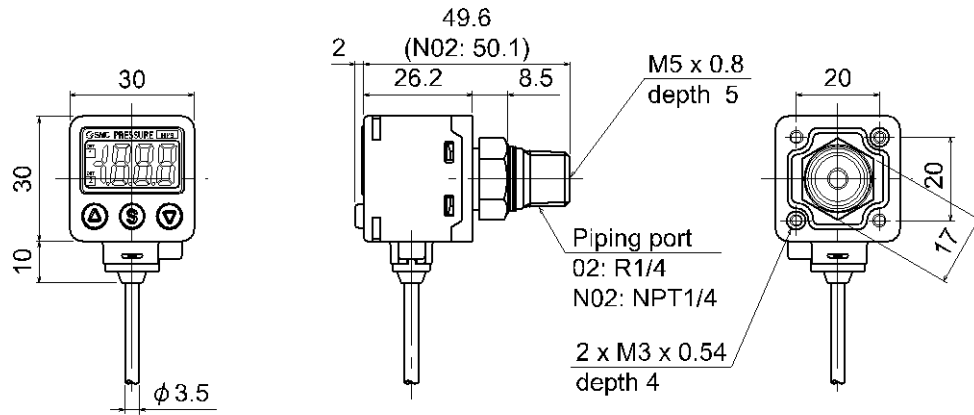

•Z/ISE80(F)-02L/N02L/C01L/A2L/B2L/-\*

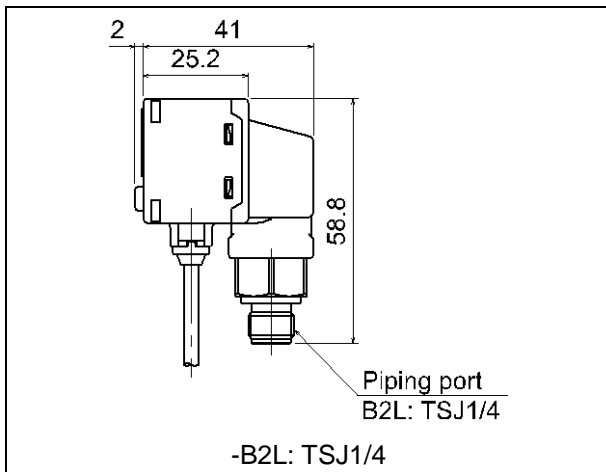
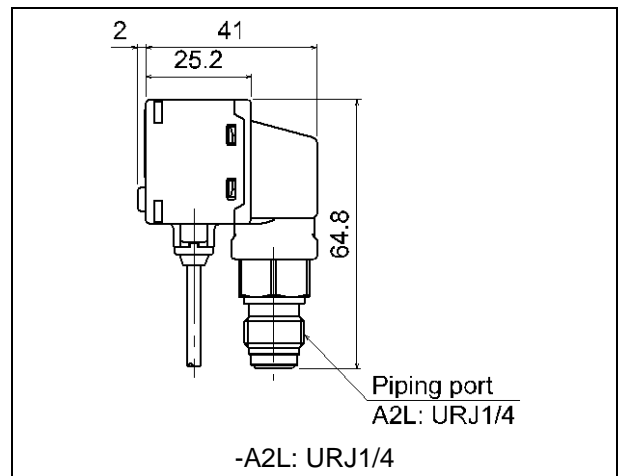
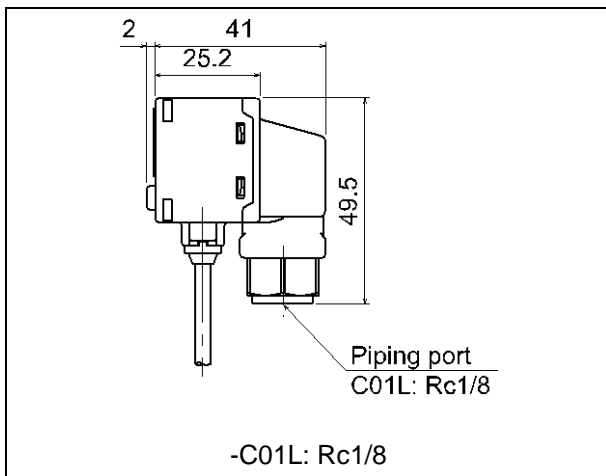
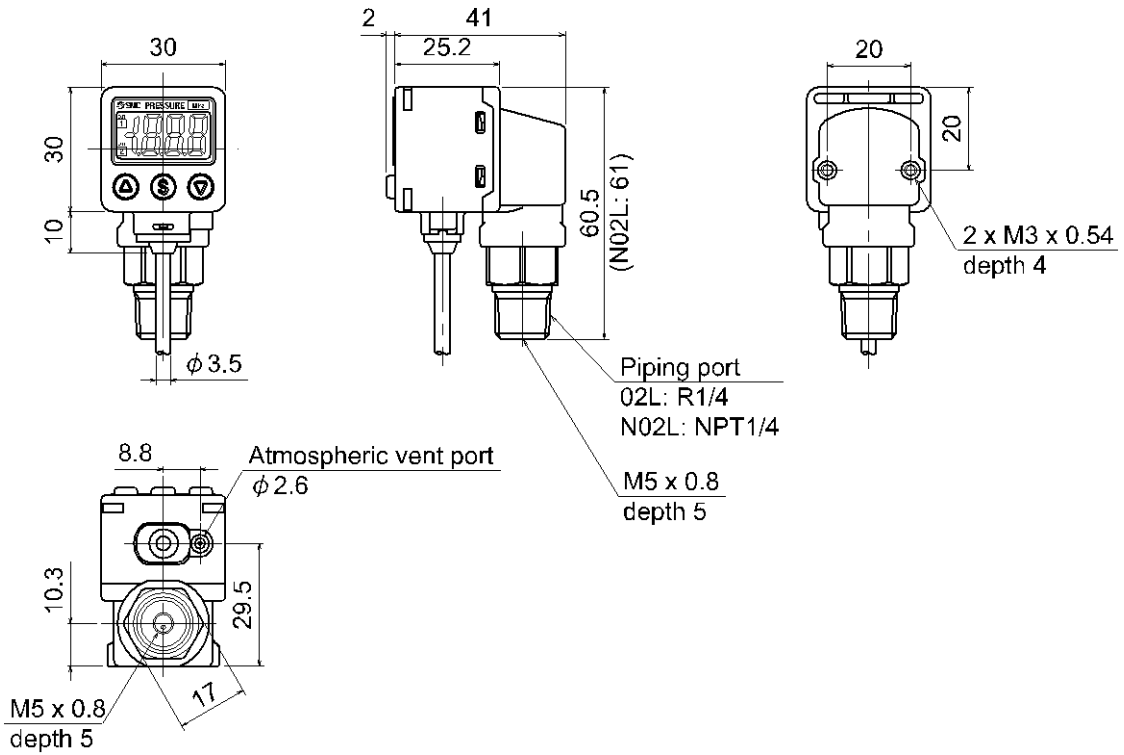

○With bracket (Rear piping)

●ZS-24-A

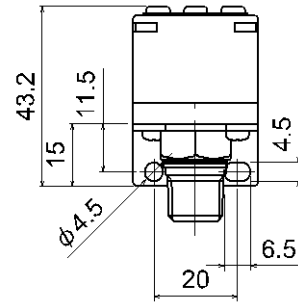
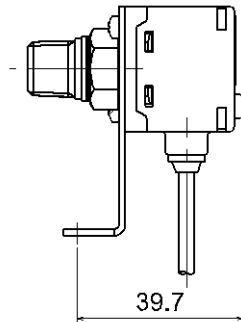
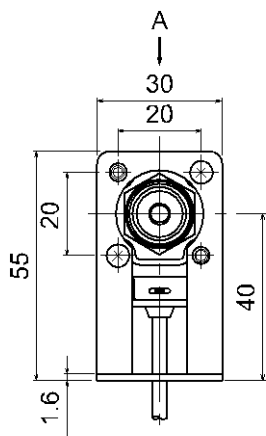

View A

○With bracket (Rear piping)

●ZS-24-D

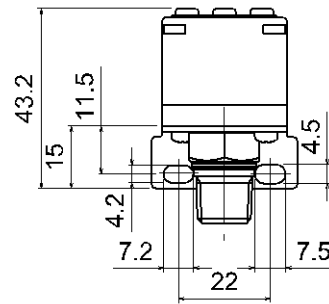
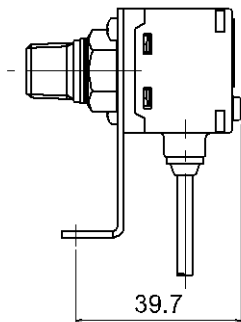
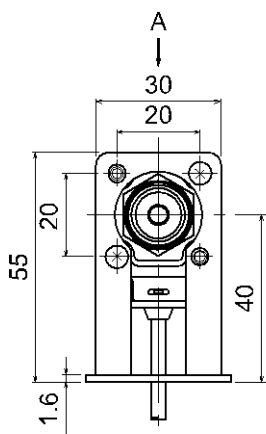

View A

○With bracket (Bottom piping)

●ZS-35-A

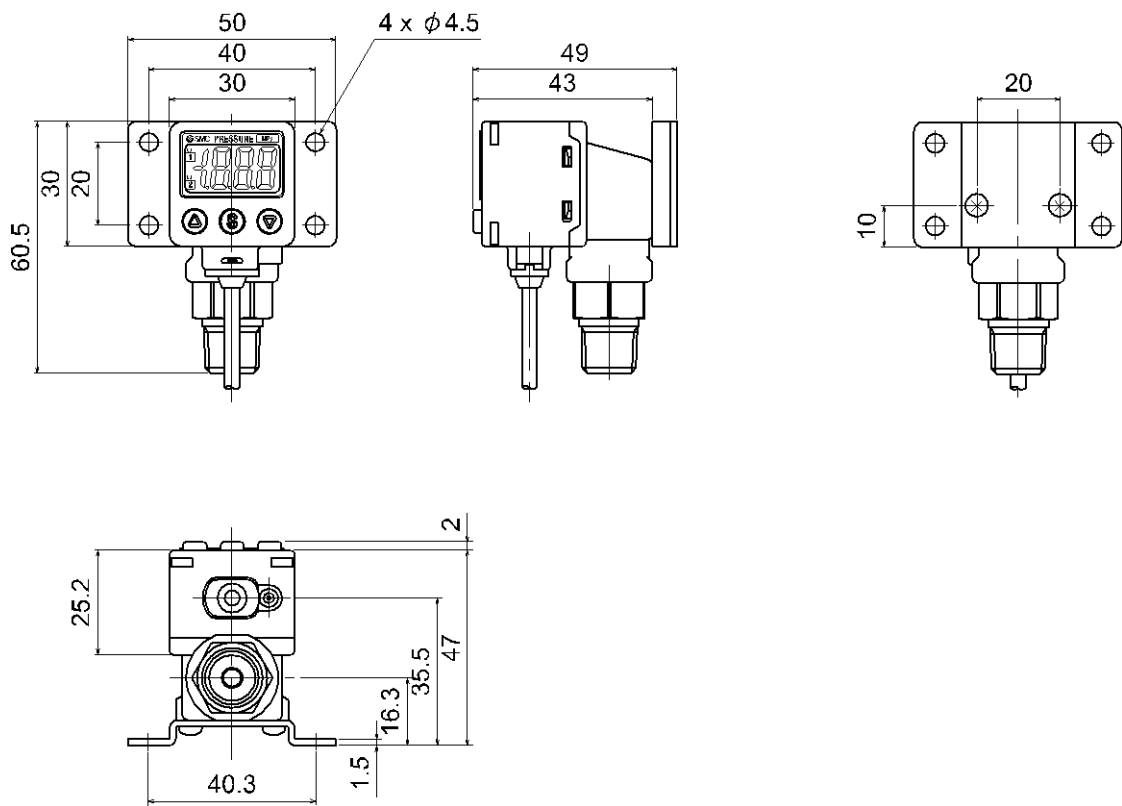



- Panel mount adapter (Rear piping)
- ZS-35-C

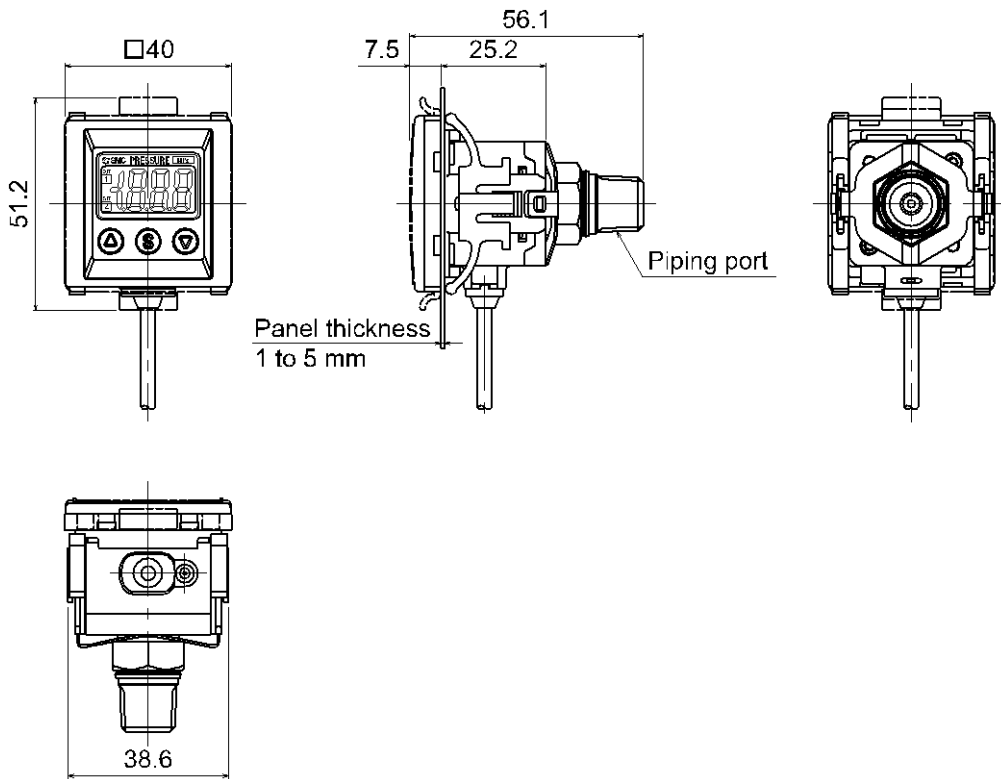

- Panel cut-out dimensions

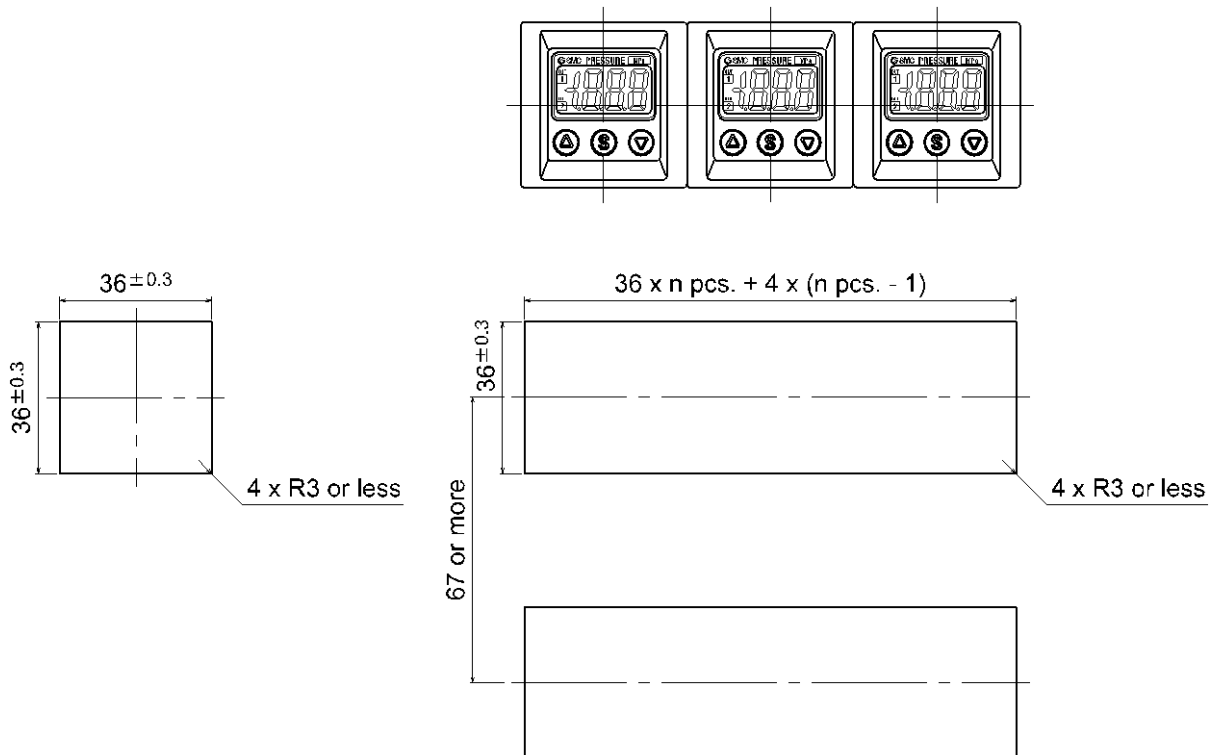

- Panel mount adapter (Bottom piping)
- ZS-35-B

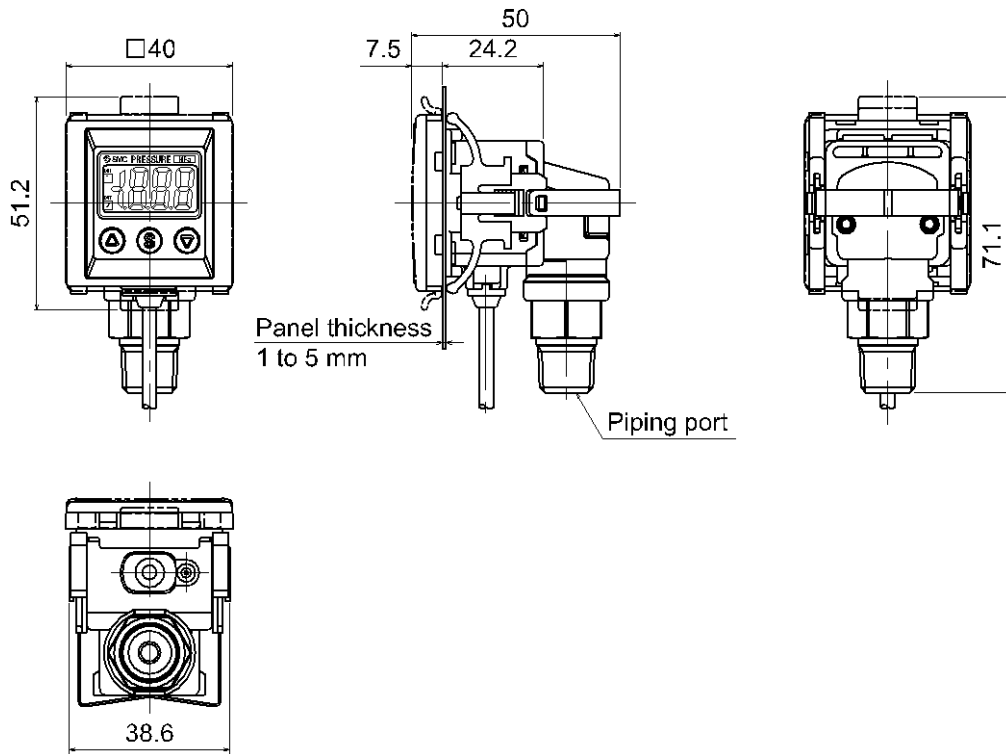

- Panel cut-out dimensions

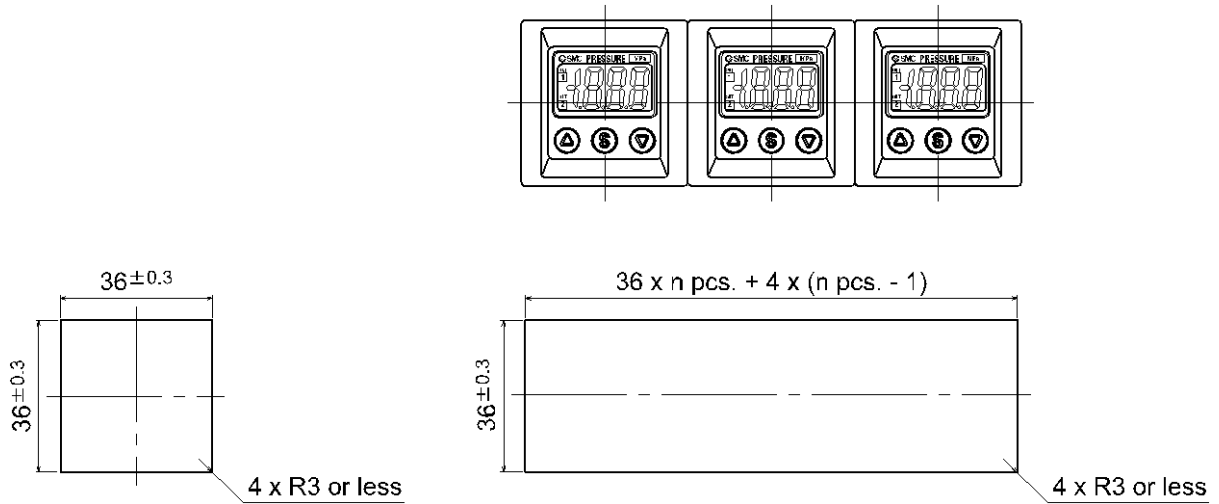

#### Revision history

A: Revision  
B: Modified errors in text  
C: Additional model  
D: Modified errors in text  
E: The following item is deleted  
    "The Pressure switch is compulsory turned off  
    for 4 seconds after power supplied."  
    Change of limited warranty and Disclaimer  
F: Measurement laws are added.  
G: Contents revised in several places.  
H: Contents revised in several places. [July 2018]  
I: Contents are added. [April 2019]

## SMC Corporation

4-14-1, Sotokanda, Chiyoda-ku, Tokyo 101-0021 JAPAN

Tel: + 81 3 5207 8249 Fax: +81 3 5298 5362

URL <https://www.smcworld.com>

---

Note: Specifications are subject to change without prior notice and any obligation on the part of the manufacturer.  
© 2008-2019 SMC Corporation All Rights Reserved

