



# Operation Manual

PRODUCT NAME

High-precision Digital Pressure Switch

MODEL / Series / Product Number

*ISE70-#-AB*

*ISE71-#-AB*

**SMC Corporation**

## Table of Contents

Safety Instructions	2
Model Indication and How to Order	8
Summary of Product parts	9
Definition and terminology	10
Mounting and Installation	13
Installation	13
Piping	14
Wiring	16
Outline of Settings [Measurement mode]	18
Pressure Setting	19
3-Step Setting Mode	20
Simple Setting Mode	22
Function Selection Mode	24
Function selection mode	24
Default setting	24
F 0 Display units and switch output specifications function	26
F 1 Setting of OUT1	27
F 2 Setting of OUT2	30
F 3 Digital filter setting	32
F 4 Auto-preset function	33
F 6 Fine adjustment of display value	35
F10 Sub display setting	36
F11 Display resolution setting	42
F14 Zero cut-off setting	43
F80 Power saving mode	44
F81 Security code	45
F90 Setting of all functions	47
F96 Number of pressurizing error	49
F98 Output check	50
F99 Reset to default settings	52
Other Settings	53
Maintenance	58
Forgotten the security code	58
Troubleshooting	59
Specifications	66
Dimensions	68



# Safety Instructions

These safety instructions are intended to prevent hazardous situations and/or equipment damage. These instructions indicate the level of potential hazard with the labels of "Caution", "Warning" or "Danger". They are all important notes for safety and must be followed in addition to International Standards (ISO/IEC)\*1), and other safety regulations.

\*1) ISO 4414: Pneumatic fluid power -- General rules relating to systems.

ISO 4413: Hydraulic fluid power -- General rules relating to systems.

IEC 60204-1: Safety of machinery -- Electrical equipment of machines. (Part 1: General requirements)

ISO 10218: Manipulating industrial robots -Safety.

etc.



## Caution

**Caution** indicates a hazard with a low level of risk which, if not avoided, could result in minor or moderate injury.



## Warning

**Warning** indicates a hazard with a medium level of risk which, if not avoided, could result in death or serious injury.



## Danger

**Danger** indicates a hazard with a high level of risk which, if not avoided, will result in death or serious injury.

## Warning

### 1. The compatibility of the product is the responsibility of the person who designs the equipment or decides its specifications.

Since the product specified here is used under various operating conditions, its compatibility with specific equipment must be decided by the person who designs the equipment or decides its specifications based on necessary analysis and test results.

The expected performance and safety assurance of the equipment will be the responsibility of the person who has determined its compatibility with the product.

This person should also continuously review all specifications of the product referring to its latest catalog information, with a view to giving due consideration to any possibility of equipment failure when configuring the equipment.

### 2. Only personnel with appropriate training should operate machinery and equipment.

The product specified here may become unsafe if handled incorrectly.

The assembly, operation and maintenance of machines or equipment including our products must be performed by an operator who is appropriately trained and experienced.

### 3. Do not service or attempt to remove product and machinery/equipment until safety is confirmed.

1. The inspection and maintenance of machinery/equipment should only be performed after measures to prevent falling or runaway of the driven objects have been confirmed.

2. When the product is to be removed, confirm that the safety measures as mentioned above are implemented and the power from any appropriate source is cut, and read and understand the specific product precautions of all relevant products carefully.

3. Before machinery/equipment is restarted, take measures to prevent unexpected operation and malfunction.

### 4. Contact SMC beforehand and take special consideration of safety measures if the product is to be used in any of the following conditions.

1. Conditions and environments outside of the given specifications, or use outdoors or in a place exposed to direct sunlight.

2. Installation on equipment in conjunction with atomic energy, railways, air navigation, space, shipping, vehicles, military, medical treatment, combustion and recreation, or equipment in contact with food and beverages, emergency stop circuits, clutch and brake circuits in press applications, safety equipment or other applications unsuitable for the standard specifications described in the product catalog.

3. An application which could have negative effects on people, property, or animals requiring special safety analysis.

4. Use in an interlock circuit, which requires the provision of double interlock for possible failure by using a mechanical protective function, and periodical checks to confirm proper operation.



# Safety Instructions

## Caution

### **1. The product is provided for use in manufacturing industries.**

The product herein described is basically provided for peaceful use in manufacturing industries. If considering using the product in other industries, consult SMC beforehand and exchange specifications or a contract if necessary. If anything is unclear, contact your nearest sales branch.

## **Limited warranty and Disclaimer/Compliance Requirements**

The product used is subject to the following "Limited warranty and Disclaimer" and "Compliance Requirements".

Read and accept them before using the product.

### **Limited warranty and Disclaimer**

#### **1. The warranty period of the product is 1 year in service or 1.5 years after the product is delivered, whichever is first.\*2)**

**Also, the product may have specified durability, running distance or replacement parts. Please consult your nearest sales branch.**

#### **2. For any failure or damage reported within the warranty period which is clearly our responsibility, a replacement product or necessary parts will be provided.**

**This limited warranty applies only to our product independently, and not to any other damage incurred due to the failure of the product.**

#### **3. Prior to using SMC products, please read and understand the warranty terms and disclaimers noted in the specified catalog for the particular products.**

**\*2) Vacuum pads are excluded from this 1 year warranty.**

**A vacuum pad is a consumable part, so it is warranted for a year after it is delivered.**

**Also, even within the warranty period, the wear of a product due to the use of the vacuum pad or failure due to the deterioration of rubber material are not covered by the limited warranty.**

### **Compliance Requirements**

#### **1. The use of SMC products with production equipment for the manufacture of weapons of mass destruction (WMD) or any other weapon is strictly prohibited.**

#### **2. The exports of SMC products or technology from one country to another are governed by the relevant security laws and regulation of the countries involved in the transaction. Prior to the shipment of a SMC product to another country, assure that all local rules governing that export are known and followed.**

## Caution

### **SMC products are not intended for use as instruments for legal metrology.**

Products that SMC manufactures or sells are not measurement instruments that are qualified by pattern approval tests relating to the measurement laws of each country.

Therefore, SMC products cannot be used for business or certification ordained by the measurement laws of each country.

## Operator

- ◆ This operation manual is intended for those who have knowledge of machinery using pneumatic equipment, and have sufficient knowledge of assembly, operation and maintenance of such equipment. Only those persons are allowed to perform assembly, operation and maintenance.
- ◆ Read and understand this operation manual carefully before assembling, operating or providing maintenance to the product.

### ■ Safety Instructions

#### **Warning**

- Do not disassemble, modify (including changing the printed circuit board) or repair.  
An injury or failure can result.
- Do not operate the product outside of the specifications.  
Do not use for flammable or harmful fluids.  
Fire, malfunction, or damage to the product can result.  
Verify the specifications before use.
- Do not operate in an atmosphere containing flammable or explosive gases.  
Fire or an explosion can result.  
This product is not designed to be explosion proof.
- Do not use the product in a place where static electricity is a problem.  
Otherwise it can cause failure or malfunction of the system.
- If using the product in an interlocking circuit:
  - Provide a double interlocking system, for example a mechanical system
  - Check the product regularly for proper operationOtherwise malfunction can result, causing an accident.
- The following instructions must be followed during maintenance:
  - Turn off the power supply
  - Stop the air supply, exhaust the residual pressure and verify that the air is released before performing maintenanceOtherwise an injury can result.

## Caution

- Do not touch the terminals and connectors while the power is on.  
Otherwise electric shock, malfunction or damage to the product can result.
- After maintenance is complete, perform appropriate functional inspections and leak tests.  
Stop operation if the equipment does not function properly or there is a leakage of fluid.  
When leakage occurs from parts other than the piping, the product might be faulty.  
Disconnect the power supply and stop the fluid supply.  
Do not apply fluid under leaking conditions.  
Safety cannot be assured in the case of unexpected malfunction.

## ■ NOTE

- Follow the instructions given below when designing, selecting and handling the product.
- The instructions on design and selection (installation, wiring, environment, adjustment, operation, maintenance, etc.) described below must also be followed.
- \*Product specifications
  - The direct current power supply to be used should be UL approved as follows:  
Circuit (of Class 2) which is of maximum 30 Vrms (42.4 V peak), with UL1310 Class 2 power supply unit or UL1585 Class 2 transformer.
  - The product is a UL approved product only if it has a  mark on the body.
  - Use the specified voltage.  
Otherwise failure or malfunction can result.
  - Do not exceed the specified maximum allowable load.  
Otherwise it can cause damage or shorten the lifetime of the Pressure switch.
  - Design the product to prevent reverse current when the circuit is opened or the product is forced to operate for operational check.  
Reverse current can cause malfunction or damage to the product.
  - Input data to the Pressure switch is not deleted, even if the power supply is cut off.  
(Writing time: 10,000 times, Data duration: 20 years after power off)
  - Use the clean air.  
This can cause operating failure.  
If compressed air containing condensate is used, install an air dryer or drain catch before the filter and perform drainage regularly.  
If drainage is not performed regularly and condensate enters the secondary side, it can cause operating failure of pneumatic equipment.  
If regular drainage is difficult, the use of a filter with an auto drain is recommended.
  - Applicable fluid is air, inert gases and incombustible gases.  
Do not use a fluid containing chemicals, synthetic oils including organic solvent, salt and corrosive gases.  
Otherwise, damage to the product and malfunction can result.  
Check the details of the specifications before using.
  - Use the specified measurement flow rate and operating pressure.  
Otherwise it can cause damage to the pressure switch or inability to measure correctly.
  - Reserve a space for maintenance.  
Allow sufficient space for maintenance when designing the system.

## ●Product handling

### \*Installation

- Tighten to the specified tightening torque.  
If the tightening torque is exceeded the mounting screws and brackets may be broken.  
If the tightening torque is insufficient, the product can be displaced and loosen the mounting screws.
- Be sure to ground terminal FG when using a commercially available switch-mode power supply.
- Do not drop, hit or apply shock to the Pressure switch.  
Otherwise damage to the internal parts can result, causing malfunction.
- Do not pull the lead wire forcefully, not lift the product by pulling the lead wire. (Tensile force 35 N or less)  
Hold the body when handling to avoid the damage of the Pressure switch which lead to cause the failure and malfunction.
- For piping of the Pressure switch, hold the piping with a spanner on the metal part of the piping (Piping attachment).  
Holding other part with spanner leads to damage the Pressure switch.
- Eliminate any dust left in the piping by air blow before connecting the piping to the product.  
Otherwise it can cause damage or malfunction.
- Do not insert metal wires or other foreign matter into the pressure measurement port.  
It can damage the pressure sensor causing failure or malfunction.
- Never mount a Pressure switch in a location that will be used as a foothold.  
The product may be damaged if excessive force is applied by stepping or climbing onto it.
- If the entering of foreign material to the fluid is possible, install and pipe the filter or the mist separator to the inlet to avoid failure and malfunction.

### \*Wiring

- Do not pull the lead wires.  
In particular, never lift a Pressure switch equipped with fitting and piping by holding the lead wires.  
Otherwise damage to the internal parts can result, causing malfunction or to be off the connector.
- Avoid repeatedly bending or stretching the lead wire, or placing heavy load on them.  
Repetitive bending stress or tensile stress can cause the sheath of the wire to peel off, or breakage of the wire.  
If the lead wire can move, fix it near the body of the product.  
The recommended bend radius of the lead wire is 6 times the outside diameter of the sheath, or 33 times the outside diameter of the insulation material, whichever is larger.  
Replace the damaged lead wire with a new one.
- Wire correctly.  
Incorrect wiring can break the Pressure switch.
- Do not perform wiring while the power is on.  
Otherwise damage to the internal parts can result, causing malfunction.
- Do not route wires and cables together with power or high voltage cables.  
Otherwise the product can malfunction due to interference of noise and surge voltage from power and high voltage cables to the signal line. Route the wires (piping) of the product separately from power or high voltage cables.
- Confirm proper insulation of wiring.  
Poor insulation (interference from another circuit, poor insulation between terminals, etc.) can lead to excess voltage or current being applied to the product, causing damage.
- Design the system to prevent reverse current when the product is forced to operate for operational check.  
Depending on the circuit used, insulation may not be maintained when operation is forced, allowing reverse current to flow, which can cause malfunction and damage the product.
- Keep wiring as short as possible to prevent interference from electromagnetic noise and surge voltage.  
Do not use a cable less than 30 m.  
Wire the DC(-) line(blue) as close as possible to the power supply.

### \*Environment

- Do not use the product in area that is exposed to corrosive gases, chemicals, sea water, water or steam.  
Otherwise failure or malfunction can result.
- Do not use in a place where the product could be splashed by oil or chemicals.  
If the product is to be used in an environment containing oils or chemicals such as coolant or cleaning solvent, even for a short time, it may be adversely affected (damage, malfunction, or hardening of the lead wires).

- Do not use in an area where surges are generated.  
If there is equipment which generates a large amount of surge (solenoid type lifter, high frequency induction furnace, motor, etc.) close to the Pressure switch, this may cause deterioration or breakage of the internal circuit of the Pressure switch. Avoid sources of surge generation and crossed lines.
- Do not use a load which generates surge voltage.  
When a surge-generating load such as a relay or solenoid is driven directly, use a Pressure switch with a built-in surge absorbing element.
- The product is CE marked, but not immune to lightning strikes. Take measures against lightning strikes in the system.
- Mount the product in a place that is not exposed to vibration or impact.  
Otherwise failure or malfunction can result.
- Prevent foreign matter such as remnant of wires from entering the Pressure switch.  
Take proper measures for the remnant not to enter the Pressure switch in order to prevent failure or malfunction.
- Do not use the product in an environment that is exposed to temperature cycle.  
Heat cycles other than ordinary changes in temperature can adversely affect the inside of the product.
- Do not expose the product to direct sunlight.  
If using in a location directly exposed to sunlight, shade the product from the sunlight.  
Otherwise failure or malfunction can result.
- Keep within the specified fluid and ambient temperatures range.  
The fluid and ambient temperatures should be 0 to 50 °C. Operation under low temperature (5 °C or less) leads to cause damage or operation failure due to frozen moist in the fluid or air.  
Protection against freezing is necessary. Air dryer is recommended for elimination of drain and water.  
Avoid sudden temperature change even within specified temperature.
- Do not operate close to a heat source, or in a location exposed to radiant heat.  
Otherwise malfunction can result.
- When the Pressure switch is used in a place which is exposed to the splash of oil and solvent all the time, protect the Pressure switch from direct splash.  
It can corrode and swell the seal (FKM, HNBR) which causes the malfunction of the Pressure switch.

#### \*Adjustment and Operation

- Turn the power on after connecting a load.  
Otherwise it can cause excess current causing instantaneous breakage of the Pressure switch.
- Do not short-circuit the load.  
Although error is displayed when the Pressure switch load is short circuit, generated excess current lead to cause the damage of the Pressure switch.
- Do not press the setting buttons with a sharp pointed object.  
It may damage the setting buttons.
- If using the product to detect very small pressure rates, warm up the product for 10 to 15 minutes first.  
There will be a drift on the display of approximate  $\pm 1\%$  immediately after the power supply is turned on, within 10 minutes.
- Perform settings suitable for the operating conditions.  
Incorrect setting can cause operation failure.  
For details of each setting, refer to page 18 to 57 of this manual.
- Do not touch the LCD during operation.  
The display can vary due to static electricity.

#### \*Maintenance

- Turn off the power supply, stop the supplied air, exhaust the residual pressure and verify the release of air before performing maintenance.  
There is a risk of unexpected malfunction.
- Perform regular maintenance and inspections.  
There is a risk of unexpected malfunction.
- Perform drainage regularly.  
If condensate enters the secondary side, it can cause operating failure of pneumatic equipment.
- Do not use solvents such as benzene, thinner etc. to clean the Pressure switch.  
They could damage the surface of the body and erase the markings on the body.  
Use a soft cloth to remove stains. For heavy stains, use a cloth soaked with diluted neutral detergent and fully squeezed, then wipe up the stains again with a dry cloth.



## Model Indication and How to Order

**ISE70** - **02** - **AB** - **M** □ □ □

Pressure range

	Symbol	Content
Positive pressure	ISE70	0 to 1 MPa
	ISE71	0 to 1.6 MPa

Piping specification

Symbol	Content
02	Rc1/4
N02	NPT1/4
F02	G1/4 *

\*: ISO1179-1 compliant

Output specification

Symbol	Content
AB	Switch output 1 + Switch output 2 (Switch output can be selected, NPN or PNP)

Option 3

Symbol	Content
Nil	With operation manual
Y	None
K	With operation manual + calibration certificate
T	With calibration certificate

Option 2

Symbol	Content
Nil	Without bracket
A	Bracket A
B	Bracket B

Option 1

Symbol	Content
Nil	Without lead wire
S	Lead wire with M12 connector (Straight: 5 m)
L	Lead wire with M12 connector (Right angle: 5 m)

Unit specification

Symbol	Content
Nil	With units selection function *1
M	Fixed SI unit *2

\*1: The new Measurement Law prohibits the use of pressure switch with the units selection function in Japan.  
A unit label is attached.

\*2: Fixed unit kPa, MPa

### ○Accessories/Part numbers

If an option is required independently, order with the following part numbers.

Items	Part No.	Remarks
Bracket A	ZS-50-A	With 2 mounting screws M4 x 6
Bracket B	ZS-50-B	With 2 mounting screws M4 x 6
Lead wire with M12 connector	ZS-31-B	Straight: 5 m
	ZS-31-C	Right angle: 5 m

## Summary of Product parts

### ○Names of individual parts

#### •Body

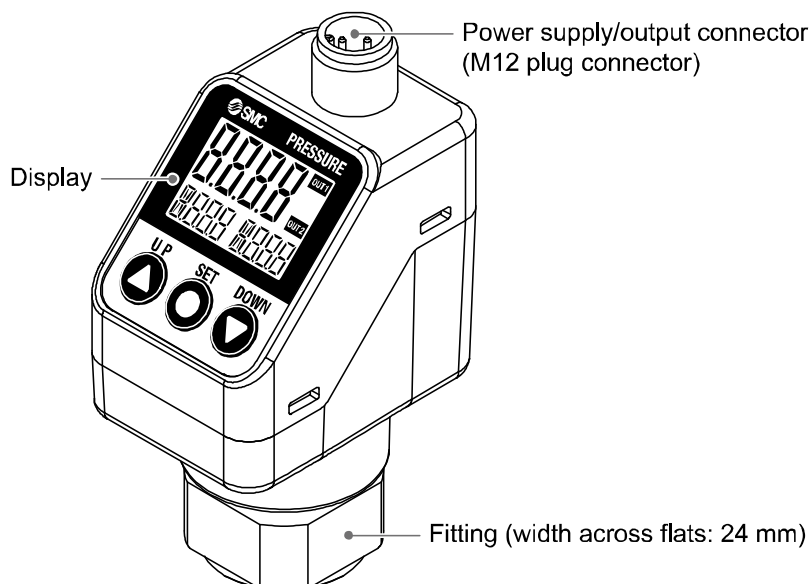

Power supply/ output connectors: Connects the power supply/ output lead wire.

Operation/Display: Refer to the table below.

#### •Operation/Display

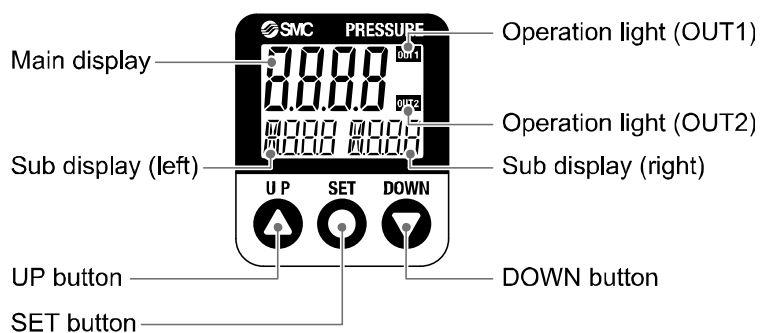

Operation light: Displays the switch operating condition.

Main display: Displays pressure measurement values and error codes. (2-colour display)

Sub display (left): Displays items. (Orange)

Sub display (right): Displays set values, peak and bottom values. (Orange)

UP button: Increases mode and ON/OFF set values.

DOWN button: Decreases mode and ON/OFF set values.

SET button: Press this button to change mode and to confirm settings.

## ■ Definition and terminology

	Term	Definition
A	Auto-preset	Performs pressure setting automatically by detecting the increase and decrease in pressure. For example, if this function is used for a suction test, the pressure setting will be completed by performing suction and release of the workpiece.
B	Bottom value display (mode)	Shows the minimum pressure from when the power was supplied to the current time.
C	Chattering	The problem of the switch output turning ON and OFF repeatedly around the set value at high frequency due to the effect of pulsation.
	Chattering prevention function	A function to delay the response time of switch output in order to prevent chattering.
D	Delay time	The setting time from when the pressure applied to the pressure switch reaches the set value, to when the ON-OFF output actually begins working. Delay time setting can prevent the output from chattering. The response time indicates when the set value is 90% in relation to the step input.
	digit (Min. setting unit)	Shows how precisely the pressure can be displayed or set by the digital pressure switch. When 1 digit = 1 kPa, the pressure is displayed in increments of 1 kPa, e.g., 1, 2, 3, ..., 99, 100.
	Digital filter	Function to add digital filtering to the fluctuation of pressure value. Smooth the fluctuation of displayed value for sharp start up or fall of the pressure. When the function is valid, digital filtering is reflected to the ON/OFF of the switch output. Output chattering or flicker in the measurement mode display can be reduced by setting the digital filter.
	Display accuracy	Shows The maximum deviation between the displayed pressure value and the true pressure.
	Display colour	Indicates the colour of the number of digital display. Always green, always red, green (switch OFF) → red (switch ON), red (switch OFF) → green (switch ON) are available.
	Display resolving power	Indicate in how many the rated pressure range can be divided to display. (Example: When the value can be displayed down to 0.001 MPa for the product for 0 to 1 Mpa, the resolution is 1/1000)
	Display value fine adjustment (function)	Displayed pressure value can be adjusted within the range of $\pm 5\%$ R.D. ( $\pm 5\%$ of displayed value). It is used if the true pressure value is known, or to eliminate differences between the displayed values of different instruments that are measuring the same pressure.
E	Error displayed	The code number displayed, identifying the error detected by the self-diagnosis function of the pressure switch. Refer to "Error indication function" on page 65 for details of the errors.
	Error output	Switches the switch output to ON/OFF when an error is displayed. Refer to "List of output modes" on page 29 for operating conditions. Refer to "Error indication function" on page 65 for details of the errors.

	Term	Definition
F	F.S. (full span/full scale)	Abbreviation of full span and full scale; difference between the minimum and maximum rated pressure values. means the maximum fluctuation range of the pressure switch rated value. For example, when the rated pressure range is -0.100 to 1.000 [MPa]: F.S. = 1.000 - (-0.100) = 1.100 [MPa] (Reference: 1%F.S. = 1.100 x 0.01 = 0.011 [MPa])
	Fine adjustment mode	Refer to "Display value fine adjustment (function)".
	Fluid contact part (or wetted part)	Part of the pressure switch which contacts detected fluid. Pressure sensor, seal and fitting are included.
	Function selection mode	A mode in which setting of functions is performed. It is a separate menu from the pressure setting. If any function settings need to be changed from the factory default, each setting can be selected with "F*". The setting items are: display colour, operation mode, output type, digital filter, display resolution, display value fine adjustment, use of auto preset, use of power saving mode, security code, etc.
H	Hysteresis	Difference between the points at which the pressure switch is turned ON and OFF.
	Hysteresis mode	Refer to the "List of output modes" on page 29.
I	Insulation resistance	Insulation resistance of the product. The resistance between the electrical circuit and the case.
K	Key-lock function	Function that prevents changes to the settings of the Pressure switch (disables button operation).
M	Manual setting	Manual pressure setup without using auto preset. This term is used to distinguish between manual and auto preset pressure setup.
	Maximum applied voltage	The maximum voltage that can be connected to the output of an NPN device.
	Maximum load current	The maximum current that can flow to the output (output line) of the switch output.
	Measurement mode	Operating condition in which pressure is being detected and displayed, and the switch function is working.
	Min. setting unit	Refer to "digit".
N	Normal output	One of the switch output types. In hysteresis mode the switch output is turned ON when pressure equal to or greater than the switch output set value is detected. In window comparator mode, the switch output is turned ON when pressure between the switch output set values (P1L to P1H) is detected. (Refer to the "List of output modes" on page 29.)
O	Operation light	A light that turns on when the switch output is ON.
	Operation mode	Either hysteresis mode or window comparator mode can be selected.
	Output style	The operation principle of the switch output. Normal output and reverse output can be selected. Please refer to the "List of output modes" on page 29 operating conditions.

	Term	Definition
P	Peak value display (mode)	Shows the maximum pressure from when the power was supplied to the current time.
	Port size	The diameter of the connecting part of the switch for connecting with the object to be measured.
	Power saving mode	Operating mode in which the digital display turns off and power consumption is reduced.
	Pressure setting	The set pressure value that determines the point at which the pressure switch turns ON and OFF.
	Proof pressure	Pressure limit that if exceeded will result in mechanical and/or electrical damage to the product.
R	R.D.	Current read value For example, when the display value is 1.000[MPa], $\pm 5\%$ R.D. is $\pm 5\%$ of 1.000[MPa], which becomes $\pm 0.05$ [MPa]. When the display value is 0.800[MPa], $\pm 5\%$ R.D. is $\pm 5\%$ of 0.800[MPa], which becomes $\pm 0.04$ [MPa].
	Rated pressure range	The pressure range within which the product will meet all published specifications. Values outside of this range can be set as long as they are within the set pressure range, but the specifications cannot be guaranteed.
	Repeatability	Variation in repeated measurement of pressure display or ON-OFF output point when the pressure changes at 25 centigrade.
	Residual voltage	The difference between the ideal ON voltage and the actual voltage when the switch output is on. Varies with load current. Ideally should be 0 V.
	Resolution	Refer to "Display resolution".
	Reversed output	One of the switch output types. In hysteresis mode the switch output is turned ON when pressure less than or equal to the switch output set value is detected. In window comparator mode, the switch output is turned ON when pressure is outside the switch output set values (n1L to n1H) is detected. (Refer to the "List of output modes" on page 29.)
	Ripple	A type of chattering.
S	Set pressure range	The pressure range that can be set for switch output.
	Switch output	Sometimes referred to as "ON-OFF output".
U	Units selection function	A function to change the units in which the measured pressure value is displayed. The display units can only be changed if the product is equipped this function. It is not possible to purchase the product with this function if the product is used in Japan. The product for Japan is displayed in SI only.
W	Window comparator mode	An operating mode in which the switch output is turned on and off depending on whether the flow is inside or outside the range of two set values. (Refer to the "List of output modes" on page 29.)
	Withstand voltage	A measure of the product's resistance to a voltage applied between the electrical circuit and case. Durability in withstanding voltage. The product may be damaged if a voltage over this value is applied. (The withstand voltage is not the supply voltage used to power the product.)
Z	Zero-clear function	This function to adjust the displayed pressure to zero.

# Mounting and Installation

## ■ Installation

### ○ Mounting with bracket

- Mount the bracket to the body with mounting screws (Cross recessed round head screw: Nominal size M4 x 6L (2 pcs)), then set the body to the specified position.

\*: Tighten the bracket mounting screws to a torque of  $0.76 \pm 0.1$  Nm.

- Bracket A (Part No.: ZS-50-A)

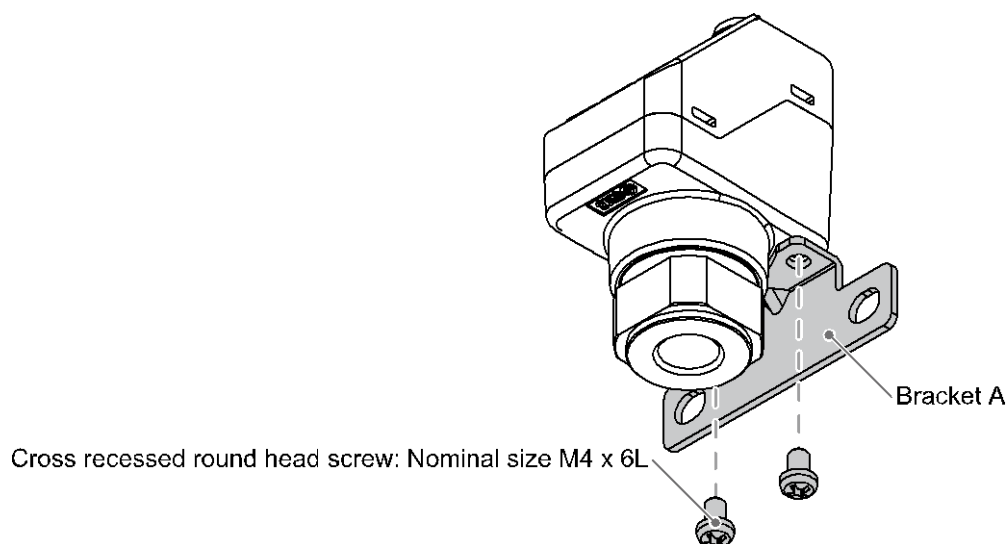

- Bracket B (Part No.: ZS-50-B)

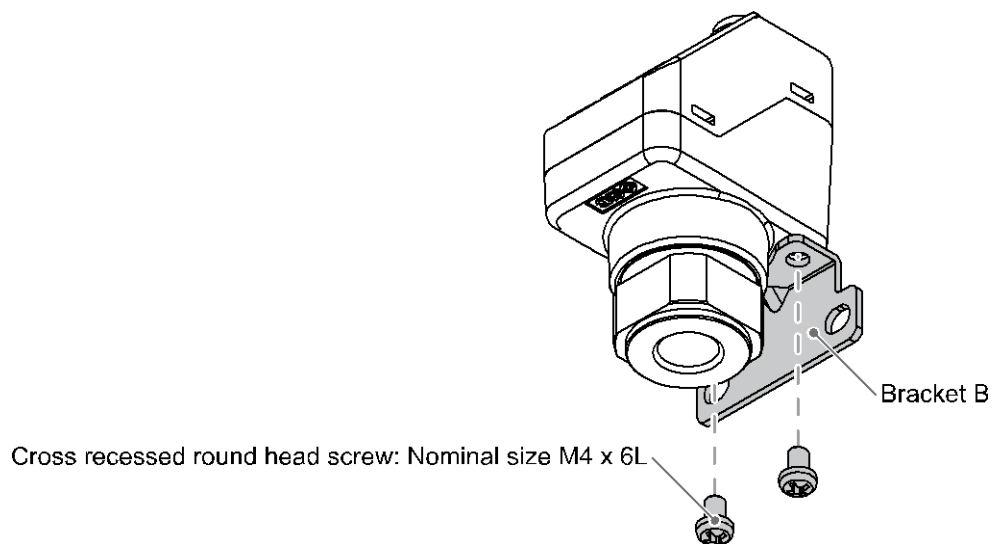

## ■Piping

- Piping specification: -02 and -N02

After hand tightening, tighten the fitting using a spanner on the flat surfaces of the fitting. The tightening torque must be 8 to 12 Nm.

- Piping specification: -F02

After hand tightening, tighten the fitting using a spanner on the flat surfaces of the fitting. The tightening torque must be 4 to 5 Nm.

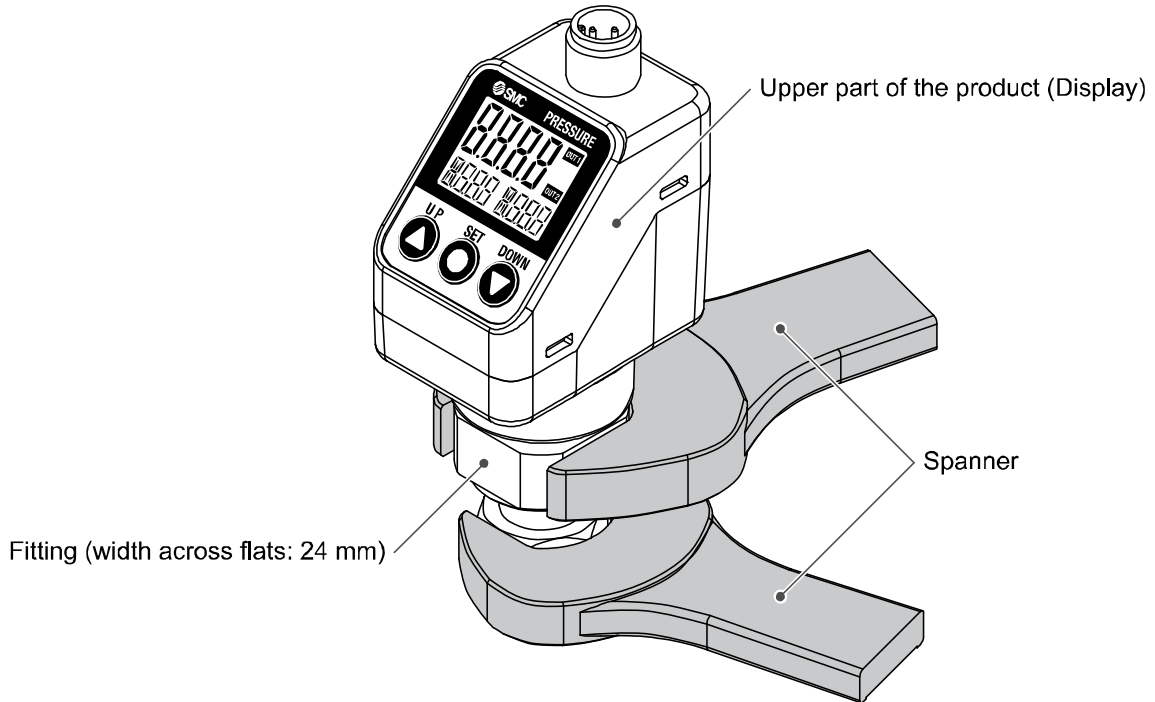

When tightening, do not hold the upper part of the product (Display) with a spanner.

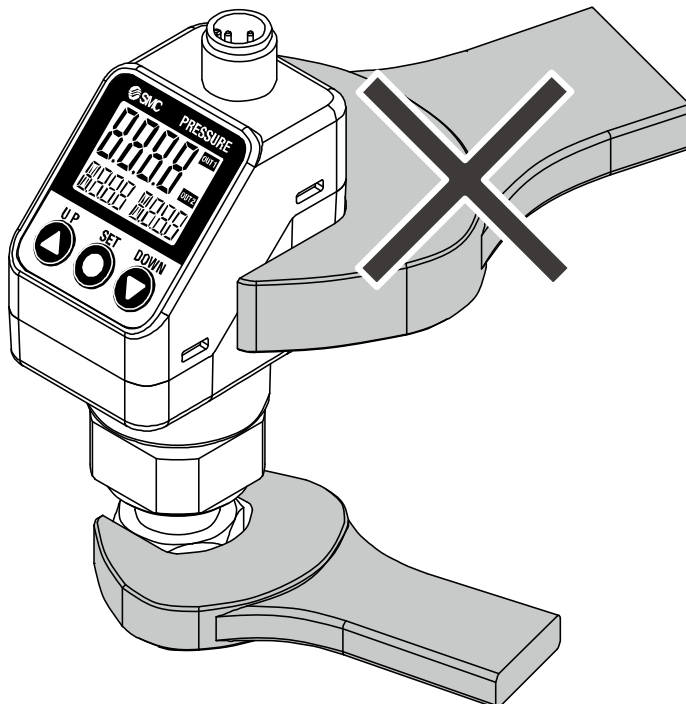

- The upper part (display) of the product can be rotated by 336°.  
Rotating the display with excessive force will damage the end stopper.

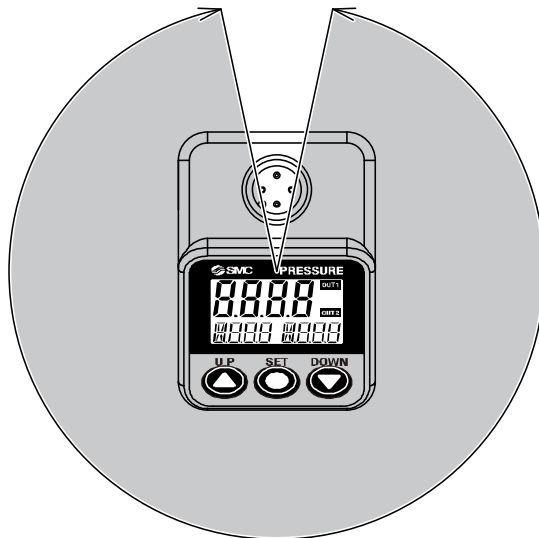

336° rotation



## ■ Wiring

- Connections should be made with the power supply turned off.
- Use a separate route for the product wiring and any power or high voltage wiring. Otherwise, malfunction may result due to noise.
- If a commercially available switching power supply is used, be sure to ground the frame ground (FG) terminal. If the switching power supply is connected, switching noise will be superimposed and it will not be able to meet the product specifications. In that case, insert a noise filter such as a line noise filter/ferrite between the switching power supplies or change the switching power supply to the series power supply.

### ○How to use connector

- Align the cable connector key groove with the product connector key to insert and rotate the knurled part of the connector.
- Connect the wires of the lead wire with M12 connector as shown below.

### M12 connector (Port Class A)

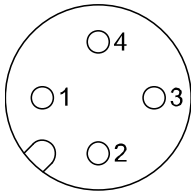

No.	Name	Lead wire colour	Function
1	DC(+)	Brown	12 to 24 VDC
2	OUT2	White	Switch output 2
3	DC(-)	Blue	0 V
4	OUT1	Black	Switch output 1

○Wiring examples

Setting of NPN open collector 2 outputs

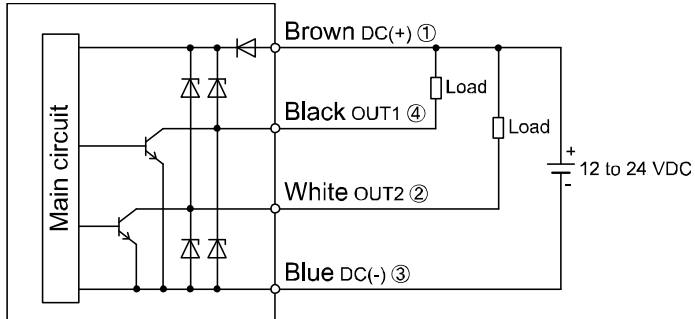

Setting of PNP open collector 2 outputs

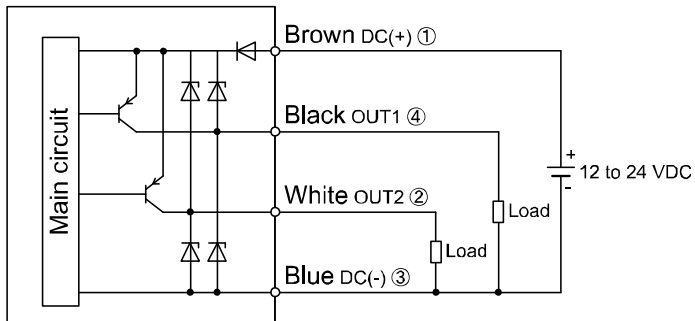

\*: Numbers in the figures show the connector pin layout.

# Outline of Settings [Measurement mode]

Power is supplied



The product code is displayed for approximately 3 seconds after power is supplied. Then, measurement mode will be displayed.

\*: Within approximately 0.2 seconds after power-on, the switch starts.



## [Measurement mode]

Detects the pressure after power is supplied, and indicates the display and switch operating status. This is the basic mode; other modes should be selected for set-point changes and other function settings.

### Measurement mode screen

Current pressure value (Main display)

Item (Sub display (left))

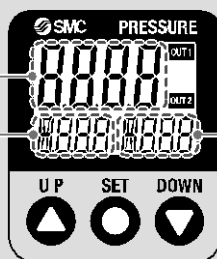

Set value or peak/bottom value (Sub display (right))

### Sub display

In measurement mode, the sub display can be temporarily changed by pressing the UP or DOWN buttons.

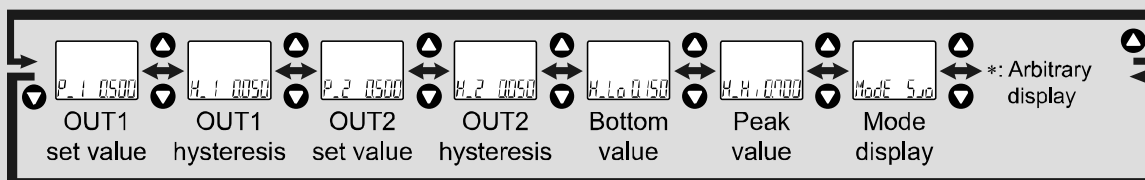

\*: One arbitrary display mode can be added to the sub display by setting the [F10] sub display.

If the sub display is switched during the arbitrary display setting, the display will be returned to the arbitrary display 30 seconds later. (The default setting does not include arbitrary display.)



Press the SET button once.



Press the SET button for 1 and 3 seconds



Press the SET button for 3 and 5 seconds



### [3 step setting mode]

Set either of set value or hysteresis. (Refer to page 20)

### [Simple setting mode]

Select the set value, hysteresis and delay time. (Refer to page 22)

### [Function selection mode]

Change the function settings. ((Refer to page 24)

### [Other Settings]

- Zero-clear function
- Key-lock function ((Refer to page 53)

\*: The outputs will continue to operate during setting.

\*: If a button operation is not performed for 30 seconds during the setting, the display will flash.

(This is to prevent the setting from remaining incomplete if, for instance, an operator were to leave during setting.)

\*: 3 step setting mode, simple setting mode and function selection mode settings are reflected each other.

## Pressure Setting

### Default settings

When the pressure exceeds the set value, the switch will be turned on. When the pressure falls below the set value by the amount of hysteresis or more, the switch will be turned off. The default setting is to turn on the pressure switch when the pressure reaches the center of the atmospheric pressure and upper limit of the rated pressure range. If this condition, shown to the below, is acceptable, then keep these settings.

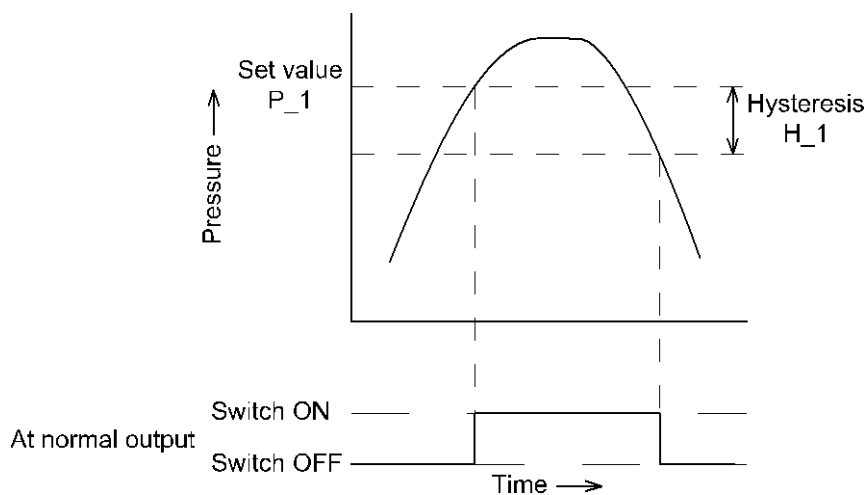

### •Default setting per pressure range

Item	ISE70	ISE71
[P_1] Set value of OUT1 [MPa]	0.500	0.800
[H_1] Hysteresis of OUT1 [MPa]	0.050	0.080

\*: OUT2 will have the same set value and hysteresis.

## 3-Step Setting Mode

### 3 step setting mode

In this mode, the set values can be input in just 3 steps.

Use this mode if the product is to be used straight away, after changing only the set values.

(The current pressure value is displayed on the main display.)

#### <Operation>

[3 step setting mode (hysteresis mode)]

In the 3 step setting mode, the set value (P\_1 or n\_1) and hysteresis (H\_1) can be changed. Set the items on the sub display (set value or hysteresis) with the UP or DOWN button. When changing the set value, follow the operation below. The hysteresis setting can be changed in the same way.

- (1) Press the SET button once when the item to be changed is displayed on the sub display.  
The set value on the sub display (right) will start flashing.

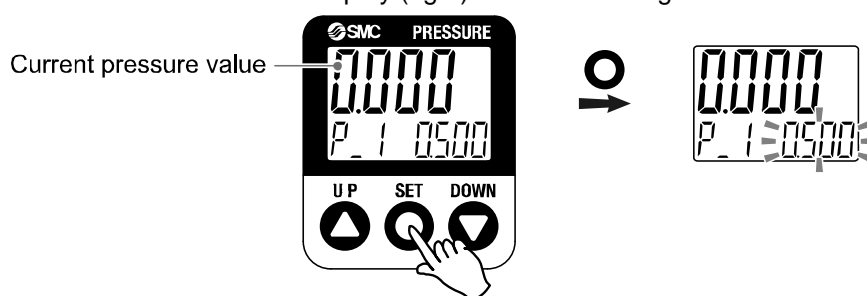

- (2) Press the UP or DOWN button to change the set value.  
The set value can be increased with the UP button and can be reduced with the DOWN button.

- Press the UP button once to increase the value by one digit, press and hold to continuously increase.

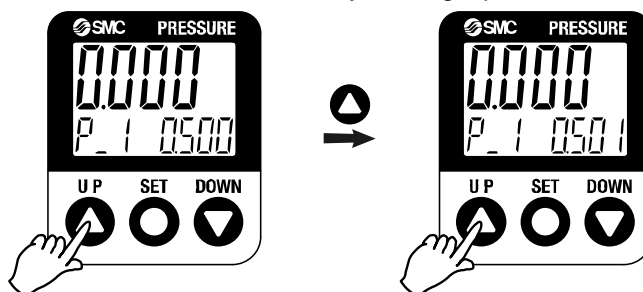

- Press the DOWN button once to reduce the value by one digit, press and hold to continuously reduce.

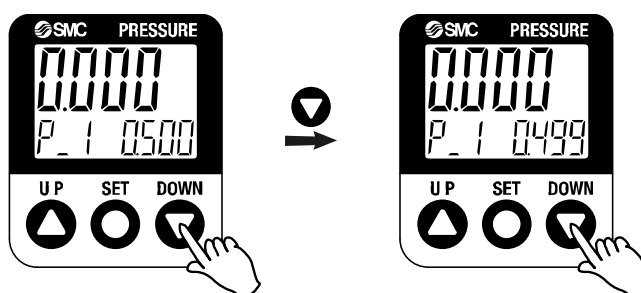

- When the UP and DOWN buttons are pressed and held simultaneously for 1 second or longer, the set value is displayed as [- - -], and the set value will be the same as the current pressure value automatically (snap shot function (Refer to page 53.)). Afterwards, it is possible to adjust the value by pressing the UP or DOWN button.

- (3) Press the SET button to complete the setting.

The Pressure switch turns on within a set pressure range (from P1L to P1H) during window comparator mode. Set P1L, the lower limit of the switch operation, and P1H, the upper limit of the switch operation and WH1 (hysteresis) following the instructions given on page 20.

(When reversed output is selected, the sub display (left) shows [n1L] and [n1H].)

Please refer to the "List of output modes" on page 29 for the relationship between the set values and operation.

\*: Set OUT2 in the same way.

Setting of the normal/reverse output switching and hysteresis/window comparator mode switching are performed with the function selection mode [F 1] OUT1 setting and [F 2] OUT2 setting.

## Simple Setting Mode

### <Operation>

[Simple setting mode (hysteresis mode)]

In the simple setting mode, the set value, hysteresis and delay time can be changed while checking the current pressure value (main display).

- (1) Press and hold the SET button for 1 and 3 seconds in measurement mode. [SEt] is displayed on the main display. When the button is released while in the [SEt] display, the current pressure value is displayed on the main display, [P\_1] or [n\_1] is displayed on the sub display (left), and the set value is displayed on the sub display (right) (Flashing).

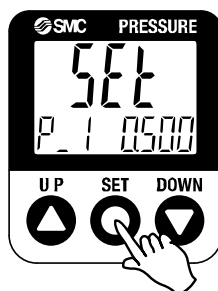

- (2) Change the set value with the UP or DOWN button, and press the SET button to set the value. Then, the setting moves to hysteresis setting. (The snap shot function can be used. (Refer to page 53.))

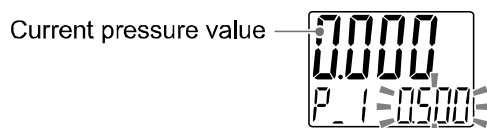

- (3) Change the set value with the UP or DOWN button, and press the SET button to set the value. Then, the setting moves to the delay time of the switch output. (The snap shot function can be used. (Refer to page 53.))



- (4) The delay time of the switch output can be selected by pressing the UP or DOWN button at the ON and OFF point of the switch output.

Delay time setting can prevent the output from chattering.

The delay time can be set in the range 0.00 to 60.00 sec. in 0.01 sec. increments.

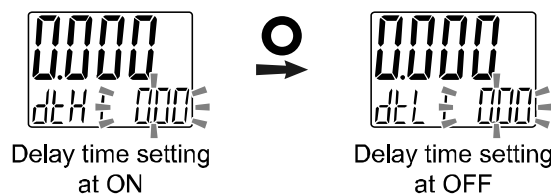

- (5) Press the SET button for less than 2 seconds to complete the OUT1 setting. [P\_2] or [n\_2] is displayed on the sub screen (left). Continue with setting the OUT2. Press and hold the SET button for 2 seconds or longer to complete the setting. The product will return to measurement mode.

\*1: Selected items (1) to (4) become valid after pressing the SET button.

\*2: After enabling the setting by pressing the SET button, it is possible to return to measurement mode by pressing the SET button for 2 seconds or longer.

\*3: When the output mode (refer to page 27) is set to error output or output OFF, the simple setting mode cannot be used. (The setting changes to measurement mode by releasing the button when [SEt] is displayed.)

In the window comparator mode, set P1L, the lower limit of the switch operation, and P1H, the upper limit of the switch operation, WH1 (hysteresis) and dtH/dtL (delay time) following the instructions given on page 22. (When reversed output is selected, the sub display (left) shows [n1L] and [n1H].) Please refer to the "List of output modes" on page 29 for the relationship between the set values and operation.

\*: Set OUT2 in the same way.



## Function Selection Mode

### ■ Function selection mode

In measurement mode, press the SET button for 3 and 5 seconds, to display [F 0]. Select to display the function to be changed [F□□]. Press and hold the SET button for 2 seconds or longer in function selection mode to return to measurement mode.

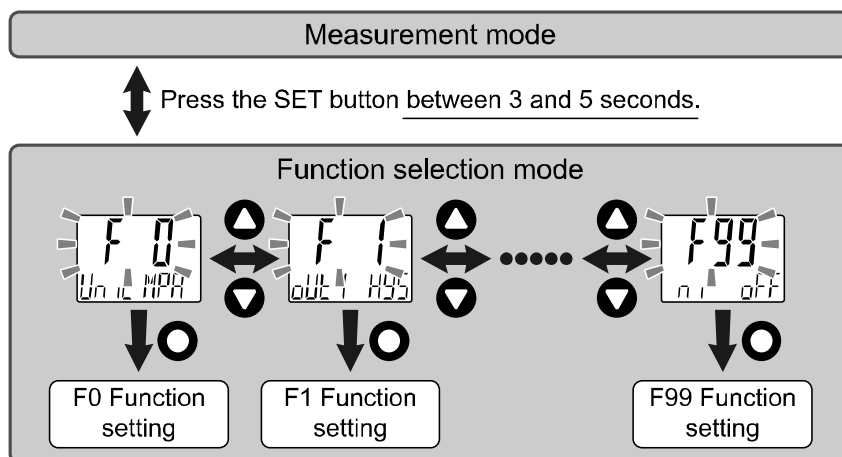

\*: Some products do not have all the functions. If no function is available or selected due to configuration of other functions, [- -] is displayed on the sub display (right).

### ■ Default setting

The default setting is as follows.

If no problem is caused by this setting, keep these settings.

To change a setting, enter function selection mode.

#### ● [F 0] Display units and switch output specifications function ➡ Page 26

Item	Default setting
Display units	Units specification ["Nil" or M]: MPa
Switch output specifications	PNP

#### ● [F 1] Setting of OUT1 ➡ Page 27

Item	Explanation	Default setting
Output mode	Either hysteresis mode, window comparator mode, error output or switch output OFF can be selected.	Hysteresis mode
Reversed output	Selects which type of switch output is used, normal or reversed.	Normal output
Pressure setting	Sets the ON and OFF point of the switch output.	ISE70: 0.500 MPa ISE71: 0.800 MPa
Hysteresis	Appropriate setting of the hysteresis will prevent the switch output from chattering.	ISE70: 0.050 MPa ISE71: 0.080 MPa
Delay time	Delay time of the switch output can be selected.	0.00 sec.
Display colour	Select the display colour.	Output ON: Green Output OFF: Red (Linked to OUT1)

●[F 2] Setting of OUT1 ➡ Page 30

Item	Explanation	Default setting
Output mode	Either hysteresis mode, window comparator mode, error output or switch output OFF can be selected.	Hysteresis mode
Reversed output	Selects which type of switch output is used, normal or reversed.	Normal output
Pressure setting	Sets the ON and OFF point of the switch output.	ISE70: 0.500 MPa ISE71: 0.800 MPa
Hysteresis	Appropriate setting of the hysteresis will prevent the switch output from chattering.	ISE70: 0.050 MPa ISE71: 0.080 MPa
Delay time	Delay time of the switch output can be selected.	0.00 sec.
Display colour	Select the display colour.	Output ON: Green Output OFF: Red (Linked to OUT1)

●Other parameter settings

Item	Page	Default setting
[F 3] Digital filter setting	Page 32	0.00 ms
[F 4] Auto-preset	Page 33	OFF
[F 6] Fine adjustment of display value	Page 35	0.0%
[F10] Sub display setting	Page 36	std (Standard)
[F11] Display resolution setting	Page 42	1000-split
[F14] Zero cut-off setting	Page 43	0.0
[F80] Power saving mode	Page 44	OFF
[F81] Security code	Page 45	OFF
[F90] Setting of all functions	Page 47	OFF
[F96] Number of pressurizing errors	Page 49	—
[F98] Output check	Page 50	N/A (normal output)
[F99] Reset to default settings	Page 52	OFF

■ [F 0] Display units and switch output specifications function

This setting is only available for models with the units selection function.

<Operation>

Press the UP or DOWN button in function selection mode to display [F 0].

Press the SET button. ↓ Move on to display unit setting.

**Display unit setting**

Press the UP or DOWN button to select the display unit.

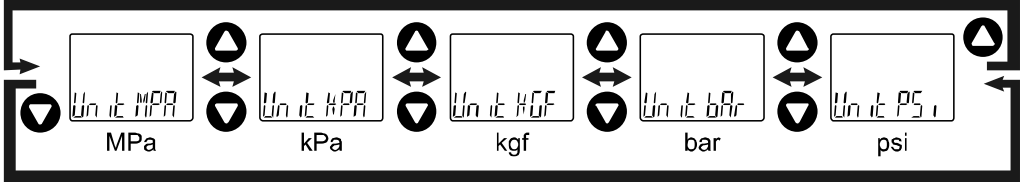

\*: MPa/kPa can be selected if the product does not have the unit selection function.

Press the SET button to set. ↓ Move on to the switch output NPN/PNP specification switching setting.

**Switching setting of switch output NPN/PNP specifications**

The switch output of this product can be switched to NPN or PNP output in accordance with the user device construction.

Press the UP or DOWN button to select switch output specification.

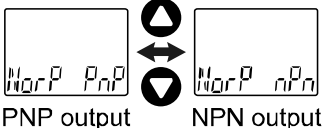

Press the SET button to set. ↓ Return to function selection mode.

[F 0] Setting of the display units and switch output specifications function is completed.

● Available display unit and minimum set value

Unit	ISE70	ISE71
MPa	0.001	
kPa	1	
kgf/cm <sup>2</sup>	0.01	
bar	0.01	
psi	0.1	

## ■[F 1] Setting of OUT1

Set the output mode of OUT1.

Output turns on when the pressure is greater than the set value. The default setting is to turn on the product when the pressure reaches the center of the atmospheric pressure and upper limit of the rated pressure range.

Output ON lights in green and output OFF lights in red as default setting.

Please refer to the "List of output modes" on page 29 for the relationship between the set items and operation.

### <Operation>

Press the UP or SET button in function selection mode to display [F 1].

Press the SET button. ↓ Move on to output mode setting.

**Output mode setting**

Press the UP or DOWN button to select the required output mode.

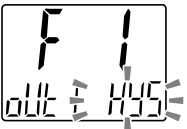

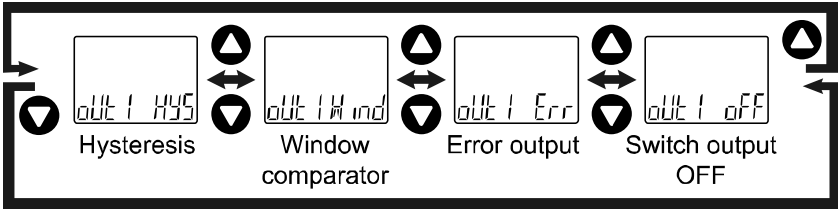

Press the SET button to set. ↓ Move on to reversed output setting.

**Reversed output setting**

Press the UP or DOWN button to select the reversed output.

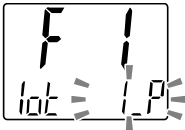

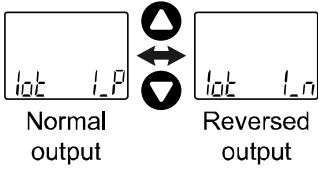

Press the SET button to set. ↓ Move on to pressure setting.

**Pressure setting**

Set the pressure based on the setting method on page 20.



Hysteresis mode: [P\_1]  
 Window comparator mode: [P1L] [P1H]  
 "P" is changed to "n" as [P\_1] → [n\_1] when reversed output is selected.  
 The snap shot function can be used.  
 (Refer to page 53)

Press the SET button to set. ↓ Move on to hysteresis setting.

[Err] Error output is selected.  
 Press the SET button to move on to display colour setting.

[OFF] Switch output OFF is selected.  
 Press the SET button to move on to display colour setting.

### Hysteresis setting

Set the pressure referring to the setting method on page 20.



Hysteresis mode: [H\_1]  
Window comparator mode: [WH1]  
The snap shot function can be used.  
(Refer to page 53)

Press the SET button to set. ↓ Move on to delay time setting.

### Delay time setting

Set the delay time referring to the setting method on page 22.

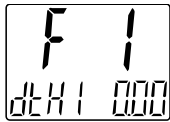

Delay time setting at ON



Delay time setting at OFF

Press the SET button to set. ↓ Move on to display colour setting.

### Display colour setting

Press the UP or DOWN button to select the display colour.

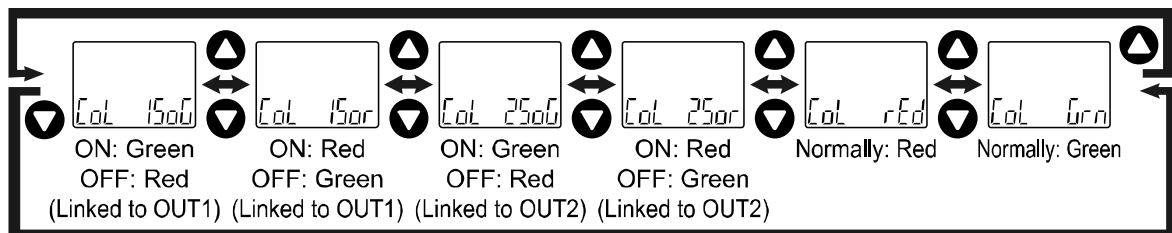

Press the SET button to set. ↓ Return to function selection mode.

[F 1] Setting of OUT1 completed

\*1: Selected item becomes valid after pressing the SET button.

\*2: After enabling the setting by pressing the SET button, it is possible to return to the measurement mode by keeping pressing the SET button for 2 seconds or longer.

●List of output modes

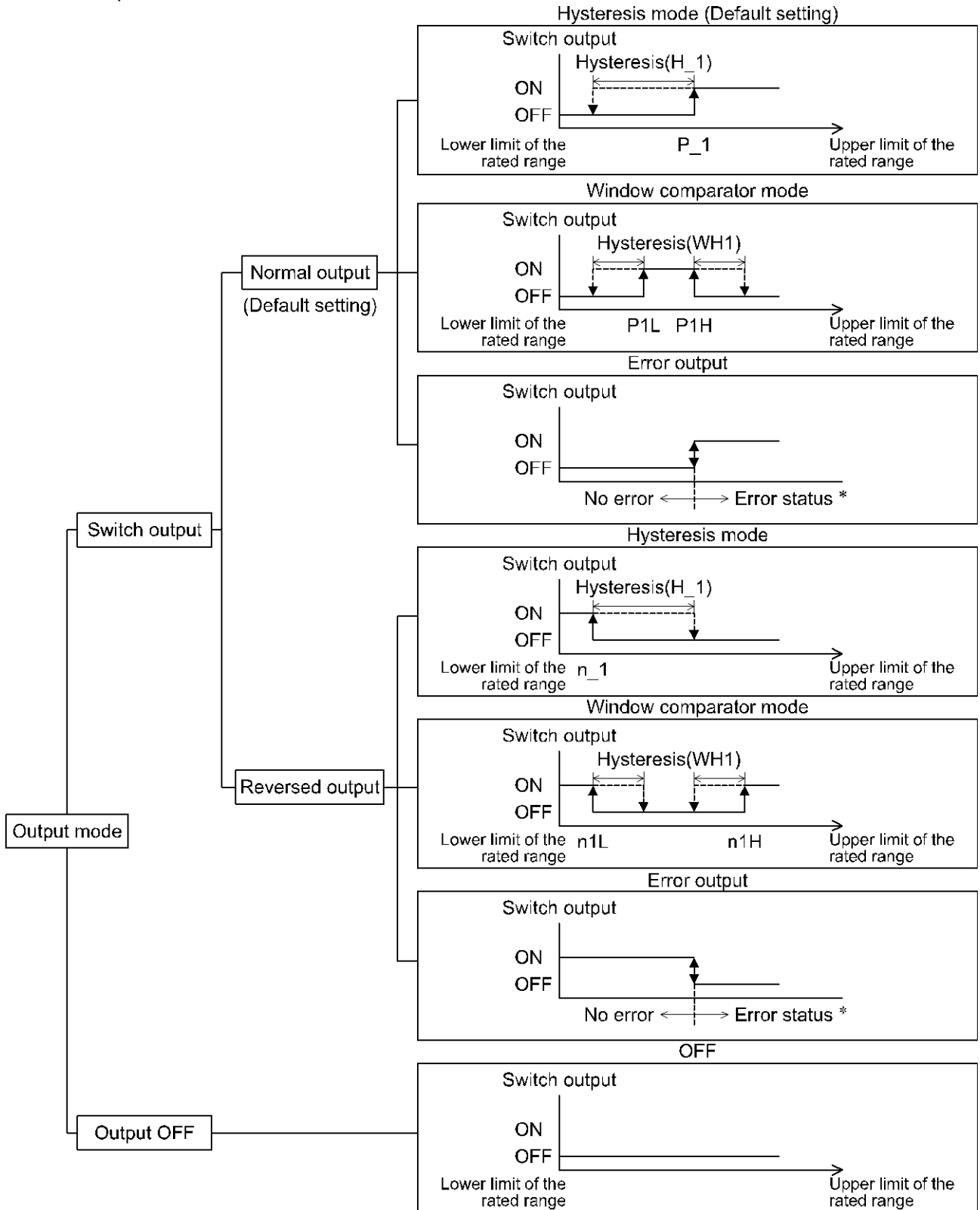

\*: Applicable errors are Er0, 4 to 9.

If the point at which the switch output changes is outside of the set pressure range due to the selection of normal or reversed output, the hysteresis value is automatically adjusted.

\*: The figure above shows an operation at OUT 1. For OUT2, all "1" in the figure will be changed to "2". (e.g.)  $P_1 \rightarrow P_2$

## ■[F 2] Setting of OUT2

Set the output mode of OUT2.

Output turns on when the pressure is greater than the set value. The default setting is to turn on the product when the pressure reaches the center of the atmospheric pressure and upper limit of the rated pressure range.

Please refer to the "List of output modes" on page 29 for the relationship between the set items and operation.

### <Operation>

Press the UP or DOWN button in function selection mode to display [F 2].

Press the SET button. ↓ Move on to output mode setting.

**Output mode setting**

Press the UP or DOWN button to select the required output mode.



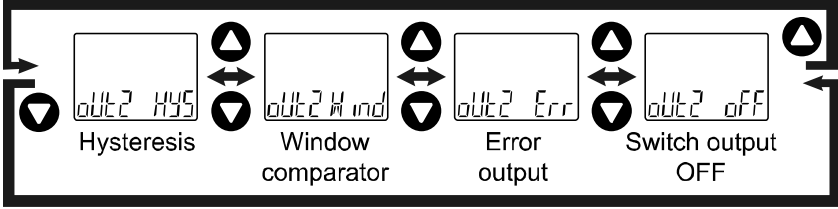

Press the SET button to set. ↓ Move on to reversed output setting.

**Reversed output setting**

Press the UP or DOWN button to select the reversed output.



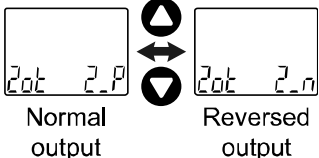

Press the SET button to set. ↓ Move on to pressure setting.

**Pressure setting**

Set the pressure based on the setting method on page 20.



Hysteresis mode: [P\_1]  
 Window comparator mode: [P1L] [P1H]  
 "P" is changed to "n" as [P\_1] → [n\_1] when reversed output is selected.  
 The snap shot function can be used.  
 (Refer to page 53)

[Err] Error output is selected.

Press the SET button to move on to display colour setting.

Press the SET button to set. ↓ Move on to hysteresis setting.

[OFF] Switch output OFF is selected.  
 Press the SET button to move on to display colour setting.

### Hysteresis setting

Set the pressure referring to the setting method on page 20.



Hysteresis mode: [H\_1]  
Window comparator mode: [WH1]  
The snap shot function can be used.  
(Refer to page 53)

Press the SET button to set. ↓ Move on to delay time setting.

### Delay time setting

Set the delay time referring to the setting method on page 22.



Delay time setting at ON



Delay time setting at OFF

Press the SET button to set. ↓ Move on to display colour setting.

### Display colour setting

Press the UP or DOWN button to select the display colour.

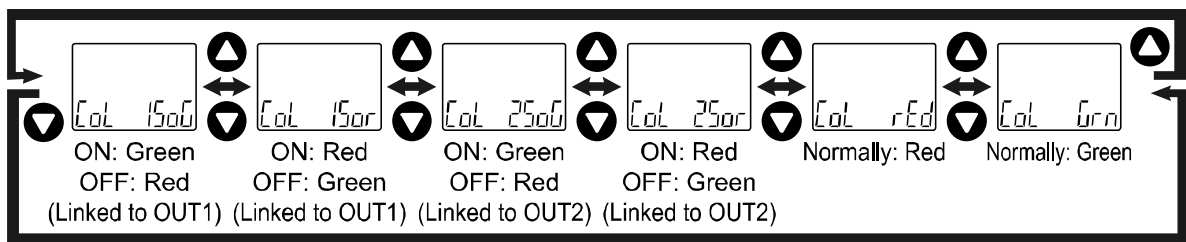

Press the SET button to set. ↓ Return to function selection mode.

[F 2] Setting of OUT2 completed

\*1: Selected item becomes valid after pressing the SET button.

\*2: After enabling the setting by pressing the SET button, it is possible to return to the measurement mode by keeping pressing the SET button for 2 seconds or longer.



## ■[F 3] Digital filter setting

The Digital filter can be selected to filter the pressure measurement.  
Output chattering or flicker in the measurement mode display can be reduced by setting the digital filter.  
Digital filter can be set in 0.01[sec.] increment in the range of 0.00 to 30.00 sec.

### <Operation>

Press the UP or DOWN button in function selection mode to display [F 3].

Press the SET button. ↓ Move on to digital filter setting.

#### Digital filter setting

Press the UP or Down button to change the digital filter set time.

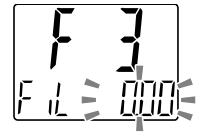

Press the SET button to set. ↓ Return to function selection mode.

[F 3] Digital filter setting completed

\*1: Each set value is a guideline for 90% response time.

\*2: Both the switch output and pressure display are affected. When only switch output needs to be affected, select the delay time setting. (page 22, 28 and 31)

## ■[F 4] Auto-preset function

This function will automatically calculate and set the optimum pressure based on the actual operating condition, when hysteresis mode has been selected.

### <Operation>

Press the UP or DOWN button in function selection mode to display [F 4].

Press the SET button. ↓ Move on to auto-preset function.

#### Auto-preset function

Press the UP or DOWN button to select the auto-preset function.

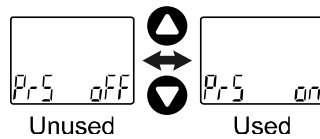

Press the SET button to set. ↓ Return to function selection mode.

[F 4] Auto-preset function completed

Press the SET button in measurement mode to perform the pressure setting.  
Then, press the SET button again to change the pressure while the display is flashing.  
(Refer to page 34 for details.)

●Auto-preset

When auto-preset is selected in function selection mode, the set value can be calculated and memorized from the measured pressure. Using this function is possible to automatically determine the optimum set value based on the variation in measured pressure due to the repeated operation of the device.

(1) Selection of auto-preset OUT1 mode

Press the SET button in measurement mode to display [AP1 REdY].  
 (If setting of OUT1 is not necessary, select [AP1 REdY], and then press the UP and DOWN buttons simultaneously for 1 second or longer.  
 The display will move to (4) Selection of auto-preset OUT2 mode.)

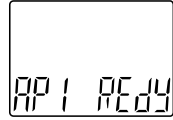

Auto-preset is ready

(2) Preparation of equipment for OUT1

Prepare the equipment for which the pressure of OUT1 is to be set.

(3) Setting of auto-preset for OUT1

Press the SET button, [AP1 RUn] will be displayed.  
 Measurement starts. Operate the device to change the pressure.  
 (If the UP and DOWN buttons are pressed simultaneously for 1 second or longer while [AP1 RUn] is displayed, measurement will be stopped and (4) Selection of auto-preset OUT2 mode will return.)



Auto-preset is being set

(4) Selection of auto-preset OUT2 mode

Press the SET button in measurement mode to display [AP2 REdY].  
 (If setting of OUT2 is not necessary, select [AP2 REdY], and then press the UP and DOWN buttons simultaneously for 1 second or longer.  
 The display will move to measurement mode.)

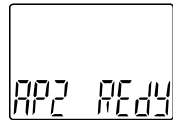

Auto-preset is ready

(5) Preparation of equipment for OUT2

Prepare the equipment for which the pressure of OUT2 is to be set.

(6) Setting of auto-preset for OUT2

Press the SET button, [AP2 RUn] will be displayed.  
 Measurement starts. Operate the device to change the pressure.  
 (If the UP and DOWN buttons are pressed simultaneously for 1 second or longer while [AP2 RUn] is displayed, measurement will be stopped and measurement mode will return.)

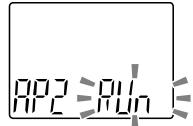

Auto-preset is being set

(7) Complete setup.

Press the SET button to complete auto-preset mode. Then, measurement mode returns.

The settings in auto-preset will be as follows.

•Normal output

$$P_1(P_2)=A-(A-B)/4$$

$$H_1(H_2)=|(A-B)/2|$$

•Reversed output

$$n_1(n_2)=B+(A-B)/4$$

$$H_1(H_2)=|(A-B)/2|$$

A = Maximum pressure

B = Minimum pressure

If setting is not necessary press the UP and DOWN buttons simultaneously for 1 second or longer.

## ■[F 6] Fine adjustment of display value

This function is to manually perform a fine adjustment of the displayed pressure value.  
Pressure can be adjusted in the following range of  $\pm 5\%$ R.D.

### <Operation>

Press the UP or DOWN button in function selection mode to display [F 6].

Press the SET button. ↓ Move on to fine adjustment of display value.

#### Fine adjustment of display value

Press the UP or DOWN button to change adjustment rate.

When adjustment rate is changed, the pressure value after the adjustment will be displayed on the main screen.

Pressure after adjustment

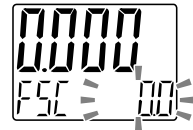

Adjustment rate

Press the SET button to set. ↓ Return to function selection mode.

[F 6] Fine adjustment of display value completed

## ■[F10] Sub display setting

Change the display style of the sub display.  
Detailed contents are shown in the pages from 37.

### <Operation>

Press the UP or DOWN button in function selection mode to display [F10].

Press the SET button. ↓ Move on to sub display setting.

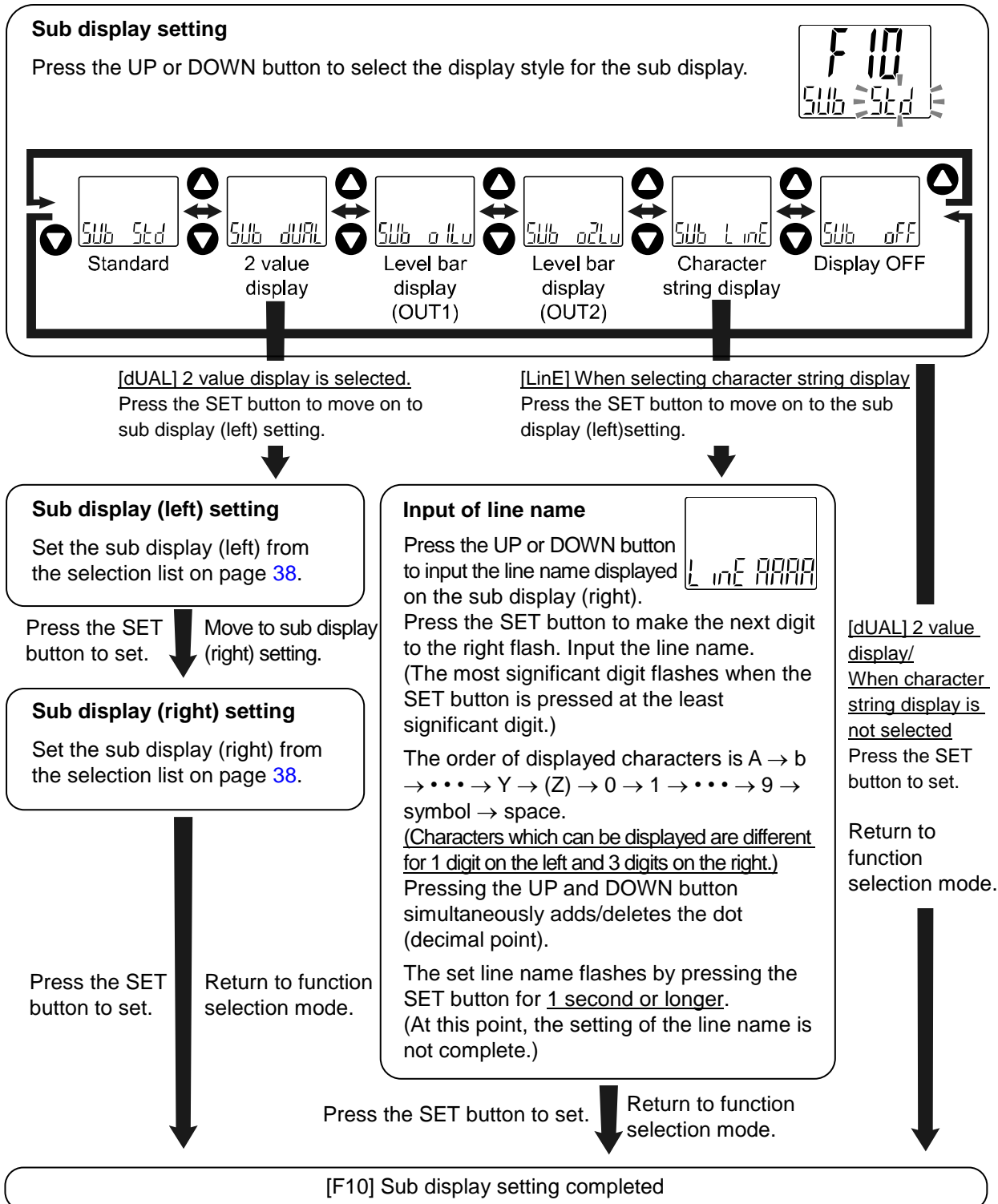

## <Sub display>

### •Standard

The Standard display function displays the items and values on the sub display.

The displayed item varies depending on the setting of the output mode. Select the displayed items by pressing the UP or DOWN button in measurement mode.

(Hysteresis mode, error output, switch output off)

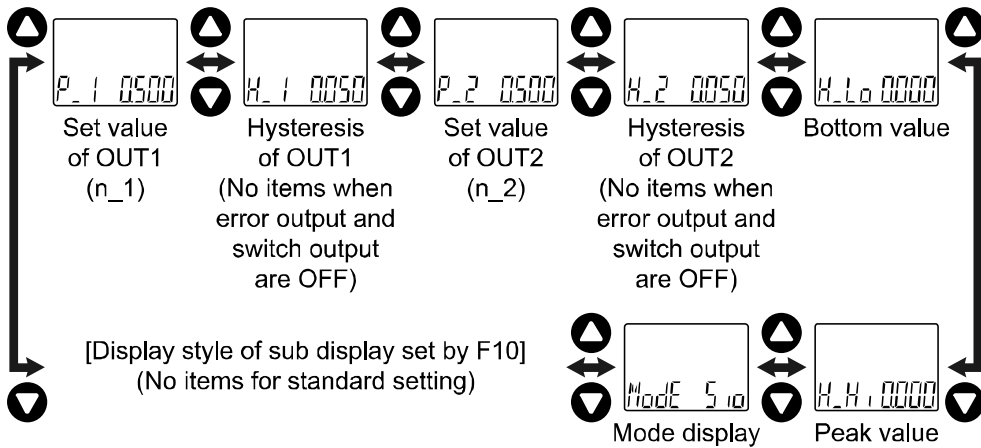

(Window comparator mode)

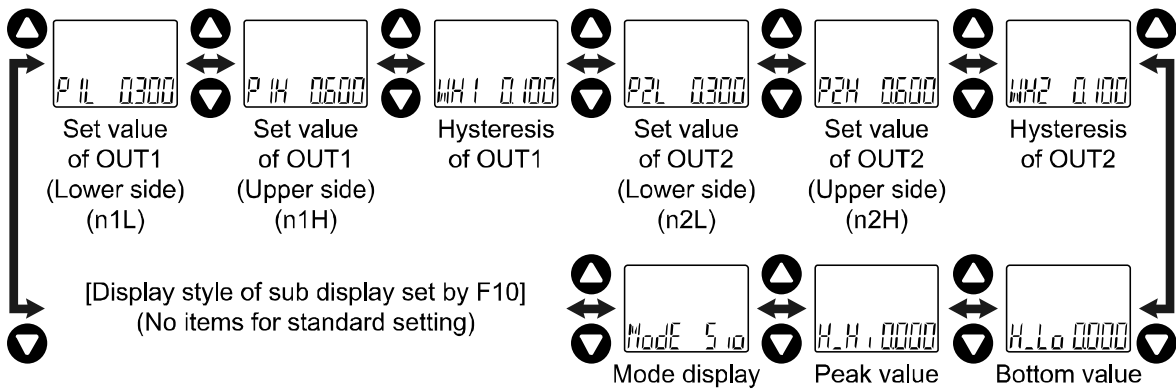





•2 value display

The 2 value display function displays the items listed below on the right and left side of the sub display.

List of items for selection

Item	Details	Sub display		Remarks
		Left side	Right side	
P <sub>1</sub> (n <sub>1</sub> )	Set value for OUT1 hysteresis mode	○	○	When hysteresis mode is selected
H <sub>1</sub>	OUT1 hysteresis mode	○	○	When hysteresis mode is selected
P <sub>1L</sub> (n <sub>1L</sub> )	OUT1 Window comparator mode set value (Lower side)	○	○	When window comparator mode is selected
P <sub>1H</sub> (n <sub>1H</sub> )	OUT1 Window comparator mode set value (Upper side)	○	○	When window comparator mode is selected
WH <sub>1</sub>	OUT1 window comparator mode	○	○	When window comparator mode is selected
P <sub>2</sub> (n <sub>2</sub> )	Set value for OUT2 hysteresis mode	○	○	When hysteresis mode is selected
H <sub>2</sub>	OUT2 hysteresis mode	○	○	When hysteresis mode is selected
P <sub>2L</sub> (n <sub>2L</sub> )	OUT2 Window comparator mode set value (Lower side)	○	○	When window comparator mode is selected
P <sub>2H</sub> (n <sub>2H</sub> )	OUT2 Window comparator mode set value (Upper side)	○	○	When window comparator mode is selected
WH <sub>2</sub>	OUT1 window comparator mode	○	○	When window comparator mode is selected
H <sub>H</sub>	Pressure peak value	○	×	
H <sub>L</sub>	Pressure bottom value	×	○	
Unit	Pressure display unit	○	○	
PRNG	Rated pressure range	○	○	
MO <sub>1</sub>	OUT1 output mode/output style	○	×	
MO <sub>2</sub>	OUT2 output mode/output style	×	○	
OUT	NPN/PNP output set value	○	○	
LINE	String of random characters	○	○	
OFF	Display OFF	○	○	

Table showing the output mode and output form when Md1 and Md2 are selected.

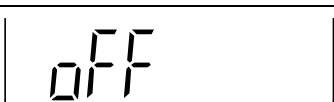
Output mode	Output style	Display style
Hysteresis mode	Normal output	
	Reversed output	
Window comparator mode	Normal output	
	Reversed output	
Error output	Normal/Reversed output	
Switch output off	—	

When using the 2 value display function, 3 step setting is not available for the display.  
 (When setting 3 step, select each set value to be displayed by pressing the UP or DOWN button.)

When output operation mode is changed after selecting the 2 value display, the selected display items will not be applicable and [- -] will be displayed. In this case, select items for the 2 value display setting again.



•Level bar display

The Level bar display is a function used to visualize the pressure and the ON area for the switch output on the sub display.

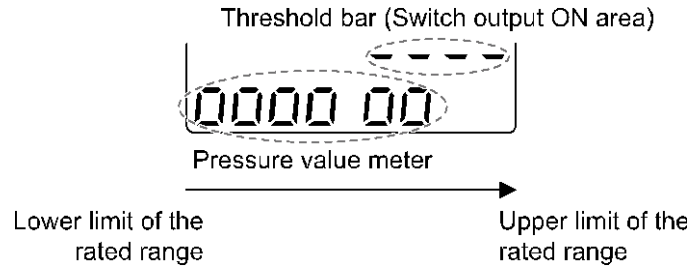

The display style varies depending on the setting of the output mode.

(In hysteresis mode or window comparator mode)

The threshold bar displaying the switch output ON area is displayed according to the table below, using the output mode.

(During error output or when the switch output is OFF)

The threshold bar will not be displayed. Only the pressure value meter is displayed.

Output mode	Output style	Threshold bar display style
Hysteresis mode	Normal output	P <sub>1</sub>
	Reversed output	n <sub>1</sub>
Window comparator mode	Normal output	P1L      P1H
	Reversed output	n1L      n1H
Error output	Normal/Reversed output	No indication
Switch output off	—	No indication

The Level bar display resolution (pressure for one "O") varies depending on the output mode.

Output mode	Display resolution	
	OUT1	OUT1
Hysteresis mode	1/10 of P <sub>1</sub> (n <sub>1</sub> )	1/10 of P <sub>2</sub> (n <sub>2</sub> )
Window comparator mode	1/4 of P1H – P1L (n1H – n1L)	1/4 of P2H – P2L (n2H – n2L)
Error output	1/7 of rated maximum pressure - rated minimum pressure	
Switch output off		

During an error output or when the switch output setting is OFF, the pressure value meter at the atmospheric pressure is displayed according to the table below.

Rated range	Display at atmospheric pressure	
Other than compound pressure		or
Compound pressure		or

**•Character string display**

•Function to display the specified character string on the sub-screen.

When line name is input, characters which can be displayed for each digit are as follows.

(Pattern for 3 digits on the right)

Characters Q, X, Z, /, or \* cannot be displayed.

A B C D E F G H I J K L M N O P R S T U V W Y

0 1 2 3 4 5 6 7 8 9 Symbol Speace (Dot)

(Pattern for 1 digit on the left)

Characters A to Z can be displayed (the same as the 3 digits on the right).

A B C D E F G H I J K L M N O P Q R S T U V W X Y Z

<Pattern for 3 digits on the right>

0 1 2 3 4 5 6 7 8 9 Symbol K M N R V W Speace (Dot)

**•Display OFF**

The Sub display is not displayed.

## ■[F11] Display resolution setting

This function is to change the pressure display resolution.  
The flicker of the display can be reduced.

### <Operation>

Press the UP or DOWN button in function selection mode to display [F11].

Press the SET button. ↓ Move on to display resolution setting.

#### Display resolution setting

Press the UP or DOWN button to select the display resolution.

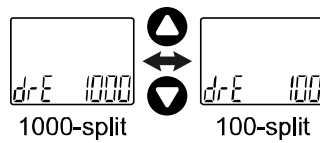

Press the SET button to set. ↓ Return to function selection mode.

[F11] Display resolution setting completed

\*: It may not be possible to change the resolution depending on the unit of pressure selected.

The units that allow display resolution to be selected are [MPa], [kPa], [kgf/cm<sup>2</sup>], [bar] and [psi].  
(The units [kgf/cm<sup>2</sup>], [bar] and [psi] can only be set when using a product with units selection function.)

➡ Page 26 [F 0] Display units and switch output specifications function

## ■[F14] Zero cut-off setting

When the pressure display value is close to zero, the product rounds the value and zero will be displayed. The zero cut-off range is 0.0 to 10.0% F.S., and can be set in 1.0% F.S. increments.

### <Operation>

Press the UP or DOWN button in function selection mode to display [F14].

Press the SET button. ↓ Move on to select zero cut-off setting.

#### Select zero cut-off setting

Press the UP or DOWN button to select the value of zero cut-off.

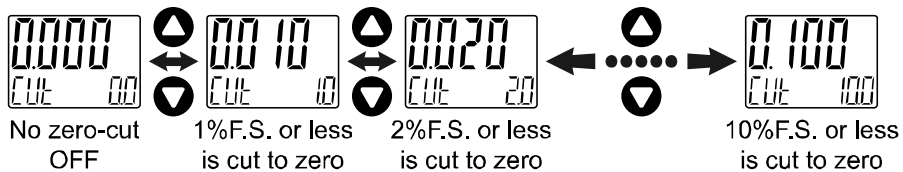

\*: The display above is an example of when [MPa] is selected for the ISE70 (1 MPa range) with the unit switching function.

\*: When the actual pressure is smaller than the displayed value in the upper line, zero will be displayed.

Example: 1 MPa range  $P_1 = 0.015$  [MPa],  $H_1 = 0.01$  [MPa], zero cut-off 1.0%

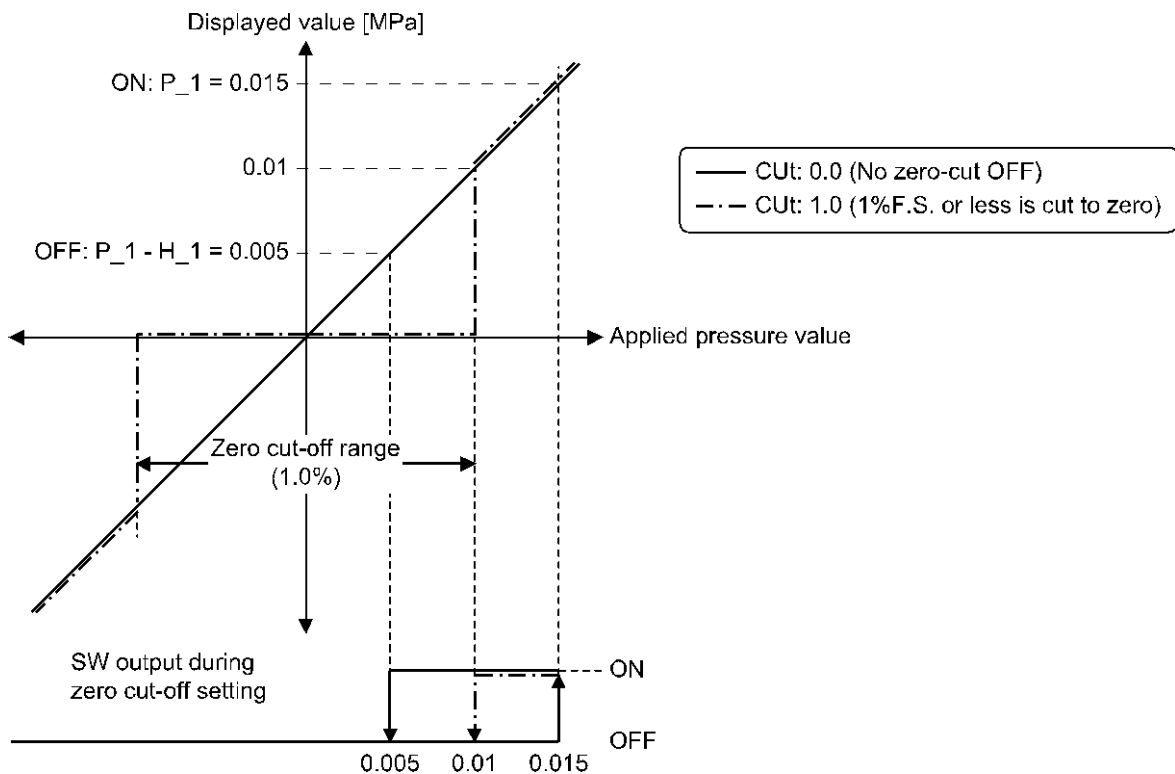

Press the SET button to set. ↓ Return to function selection mode.

[F14] Zero cut-off setting completed

## ■[F80] Power saving mode

Power saving mode can be selected.

When selected and no buttons are pressed for 30 seconds, the product will shift to power saving mode.

### <Operation>

Press the UP or DOWN button in function selection mode to display [F80].

Press the SET button. ↓ Move on to power saving mode.

#### Power saving mode

Press the UP or DOWN button to select the power saving mode.

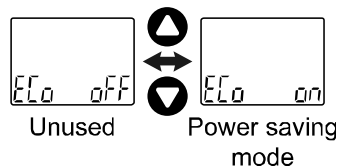

Press the SET button to set. ↓ Return to function selection mode.

[F80] Power saving mode completed

In power saving mode, when buttons are pressed the display is normal, but if no buttons are pressed for 30 seconds, it will revert to power saving mode. (Power saving is only enabled in measurement mode)

During power saving mode, [ECo] will flash in the sub display and the operation light is ON (only when the switch is ON).

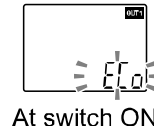

At switch ON

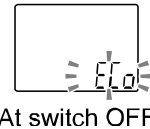

At switch OFF

## ■[F81] Security code

The security code can be turned on or off and the security code can be changed when unlocked.

### <Operation>

Press the UP or DOWN button in function selection mode to display [F81].

Press the SET button. ↓ Move on to security code.

**Security code**

Press the UP or DOWN button to select the setting of security code.

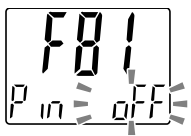
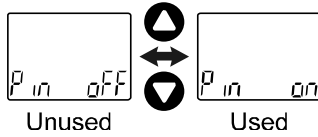

[OFF] (Unused) is selected.

Press the SET button to return to function selection mode.

Press the SET button to set. ↓ Move on to security code checking.

**Security code checking**

Press the UP or DOWN button to input the security code on the sub display (right). (The default setting is [000].) \*

For instructions on how to enter the security code, refer to "How to input and change the security code" on page 57.

If the security code entered is incorrect, [FAL] will be displayed, and the security code must be entered again.

If the wrong security code is entered 3 times, [nG] is displayed and the device returns to function selection mode.



Press the SET button for 1 second to set. ↓ Move on to security code changing.

### Security code changing

Press the UP or DOWN button to input the changed security code on the main display. \*  
For instructions on how to enter the security code, refer to "How to input and change the security code" on page 57.

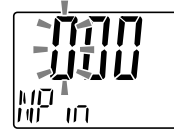

After entry, the changed security code will flash by pressing the SET button for 1 second.  
(At this point, the changing of the security code is not completed)  
Return to the change of setting again by pressing the UP or DOWN button.



Press the SET button to set. ↓ Return to function selection mode.

[F81] Security code completed

If the security code function is enabled, it is will be necessary to input a security code to release the key-lock.

\*: If a key is not pressed for 30 seconds while entering the security code, function selection mode will return.

## ● Special function setting

### ■ [F90] Setting of all functions

All functions can be set in turn.

#### <Operation>

Press the UP or DOWN button in function selection mode to display [F90].

Press the SET button. ↓ Move on to setting of all functions.

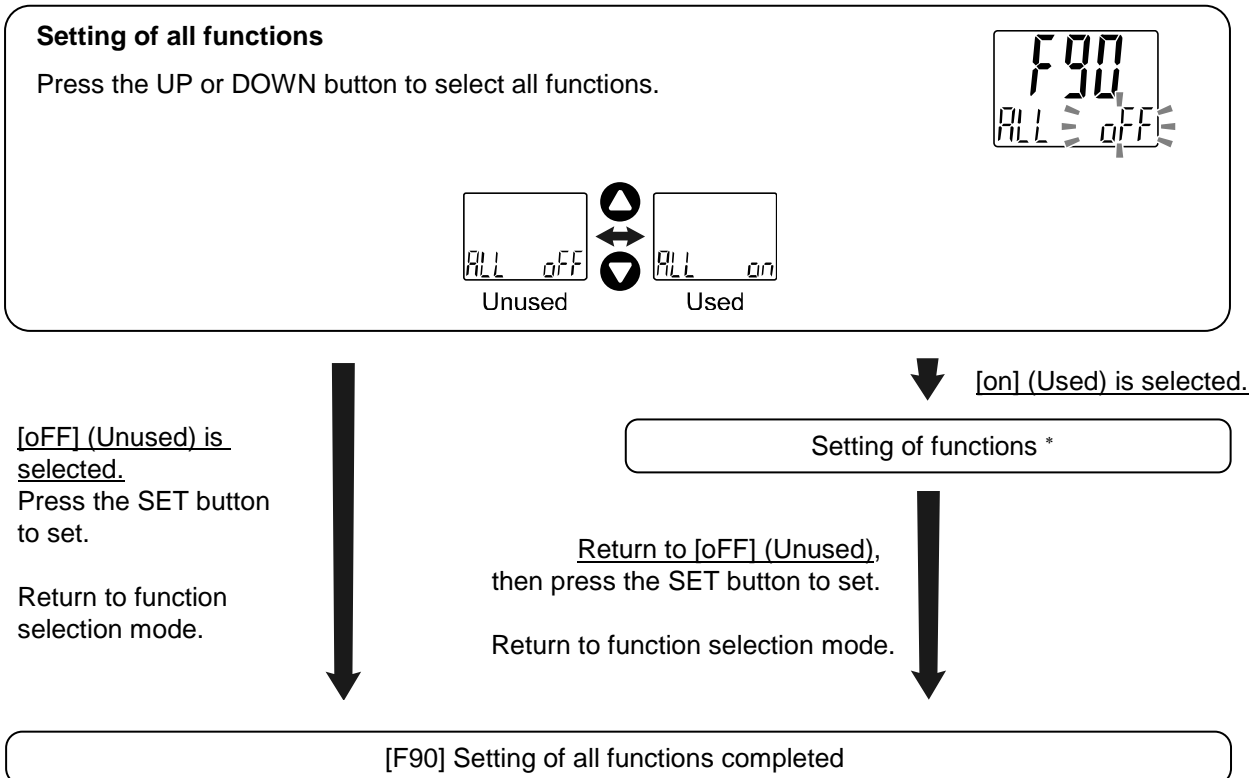

\*: Setting of each function

Every time the SET button is pressed, the display moves to the next function in order of "Setting of each function" on page 48. Set by using the UP and DOWN buttons.

For details of how to set each function, refer to the relevant setting of function section in this manual.

\*: Measurement mode can be returned from any setting items by pressing and holding the SET button for 2 seconds or longer.

\*: The function setting from before returning to the measurement mode is maintained.



● Setting of each function

Order	Function
1	Display unit selection
2	Switching setting of switch output NPN/PNP specifications
3	Output mode setting of OUT1
4	Reversed output setting of OUT1
5	Pressure setting of OUT1
6	Hysteresis setting of OUT1
7	Set OUT1 delay time at ON
8	Set OUT1 delay time at OFF
9	Display colour setting
10	Output mode setting of OUT2
11	Reversed output setting of OUT2
12	Pressure setting of OUT2
13	Hysteresis setting of OUT2
14	Set OUT2 delay time at ON
15	Set OUT2 delay time at OFF
16	Display colour setting
17	Digital filter setting
18	Auto-preset function
19	Fine adjustment of display value
20	Sub display setting
21	Display resolution setting
22	Zero cut-off setting
23	Power saving mode
24	Security code

\*: Measurement mode can return from any setting item by pressing the SET button for 2 seconds or longer.

\*: Function set before returning to the measurement mode is maintained.

## ■[F96] Number of pressurizing errors

When the pressure has exceeded 115% of the rated pressure, this is counted as a pressurizing error.

### <Operation>

Press the UP or DOWN button in function selection mode to display [F96].

Press the SET button. ↓ Move on to number of pressurizing errors



- \*: The maximum number of pressurizing error is 1000 counts.
- \*: The number of pressurizing errors counted cannot be cleared.

## ■[F98] Output check

Correct operation of the switch output can be confirmed.  
The output can be turned ON/OFF manually.

### <Operation>

Press the UP or DOWN button in function selection mode to display [F98].

Press the SET button. ↓ Move on to output check.

#### Output check

Press the UP or DOWN button to select output check.

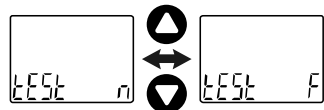

Normal output (Output not checked)      Forcibly output (Output is checked)

[F] (Forced output) is selected.  
Press the SET button to set.

[n] (Normal output) is selected.  
Press the SET button to set.

Return to function selection mode.

#### OUT1 output check

Press the UP or DOWN button to select OUT1 output check.

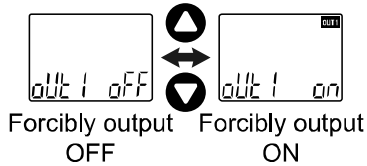
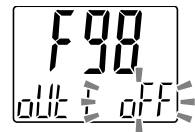

Press the SET button to set. ↓

**OUT2 output check**

Press the UP or DOWN button to select OUT2 output check.

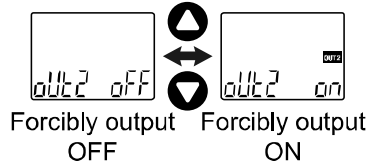

Press the SET button to return to [n] (Normal output), then press the SET button to set.

Return to function selection mode.

[F98] Output check completed

\*: Measurement mode can return from any setting item by pressing the SET button for 2 seconds or longer.

## ■[F99] Reset to default settings

If the product settings are uncertain, the default values can be restored.

### <Operation>

Press the UP or DOWN button in function selection mode to display [F99].

Press the SET button. ↓ Move on to reset to default settings.

#### Reset to default settings

Press the UP or DOWN button to display [ON], then press the SET and DOWN buttons simultaneously for 5 second or longer.

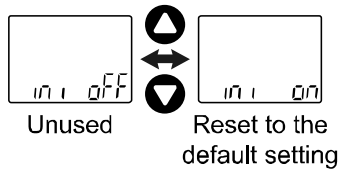

[oFF] (Unused) is selected.  
Press the SET button to set.

Return to function selection mode.

All settings are returned to the default values. Return to function selection mode.

[F99] Reset to default settings completed

## Other Settings

### ○ Snap shot function

The current pressure value can be stored to the switch output ON/OFF set point.

When the items of sub display (left) below are selected in 3 step setting mode, simple setting mode or function selection mode ([F 1] Setting of OUT1, [F 2] Setting of OUT2), by pressing the UP and DOWN buttons simultaneously for 1 second or longer, the value of the sub display (right) shows [- -], and then values corresponding to the current pressure values are automatically displayed.

Output mode	Configurable items	Sub display (left)	Snap shot function
Hysteresis mode	Set value	$P_{-1} (n_{-1}) / P_{-2} (n_{-2})$	○
	Hysteresis	$H_{-1} / H_{-2}$	○
Window comparator mode	Set value	$P_{1L} (n_{1L}), P_{1H} (n_{1H})$ $P_{2L} (n_{2L}), P_{2H} (n_{2H})$	○
	Hysteresis	$H_{1L} / H_{1H}$	×

#### • Set value

The value is set to the same value as the display value (current pressure value).

(There is a range which cannot be set to the current pressure depending on the hysteresis. In that case, the value is set to the closest value.)

#### • Hysteresis

The hysteresis is calculated from the equation below and set.

Normal output: (set value) - (current pressure value)

Reverse output: (current pressure value) - (set value)

If the calculation result becomes 0 or less, [Err] is displayed on the sub display (right) and the set value is not changed.

Afterwards, it is possible to adjust the value by pressing the UP or DOWN button.

### ○ Peak/bottom value indication

The maximum (minimum) pressure when the power is supplied is detected and updated.

In peak/bottom indication mode, the current pressure is displayed.

Press the UP or DOWN button in measurement mode to switch the sub-display (left) to the display shown below.

Peak/bottom values are displayed on the sub display (right) at the same time as the current pressure value on the main display.

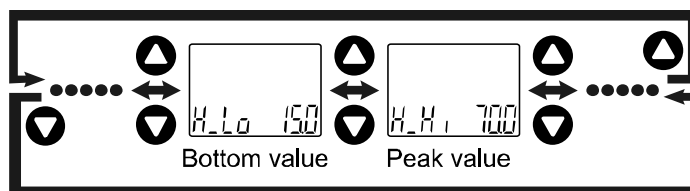

Peak/bottom values are maintained even if the power supply is cut.

When the SET and DOWN buttons are pressed for 1 second or longer simultaneously while the peak/bottom values are displayed, the sub display (right) displays [- -] and the maximum (minimum) pressure value are cleared.

### ○ Zero-clear function

The displayed value can be adjusted to zero if the pressure being measured is within  $\pm 7\%$ F.S of the zero point set at the time of default settings.

(The zero clear range varies by  $\pm 1\%$ F.S. due to variation between individual products.)

In measurement mode, when the UP and DOWN buttons are pressed for 1 second or longer simultaneously, the main display shows [- -], and the reset to zero. The display returns to measurement mode automatically.

### ○Key-lock function

The key-lock function is used to prevent errors occurring due to unintentional changes of the set values. If the SET button is pressed while the keys are locked, [LoC] is displayed on the sub display (right) for approximately 1 second.

(Each setting and peak/bottom values are displayed with UP and DOWN buttons.)

#### <Operation - Without security code input ->

- (1) Press the SET button for 5 seconds or longer in measurement mode. When [oPE] is displayed on the main display, release the button.

The current setting [LoC] or [UnL] will be displayed on the sub display.

(To release key-lock repeat the above operation.)



- (2) Select the key-locking/un-locking with UP or DOWN button, and press the SET button to set.

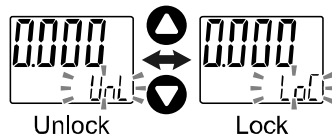

**<Operation – With security code input ->**

•Locking

(1) Press the SET button for 5 seconds or longer in measurement mode. When [oPE] is displayed on the main display, release the button.

The current setting [LoC] or [UnL] will be displayed on the sub display.

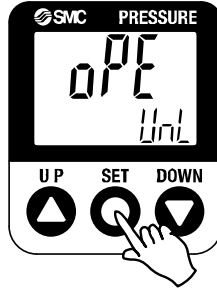

(2) Select the key [LoC] with UP or DOWN button, and press the SET button to set.

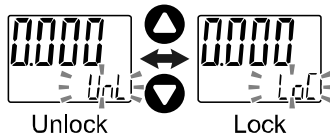



•Unlocking

- (1) Press the SET button for 5 seconds or longer in measurement mode. When [oPE] is displayed on the main display, release the button.  
The current setting [LoC] or [UnL] will be displayed on the sub display.

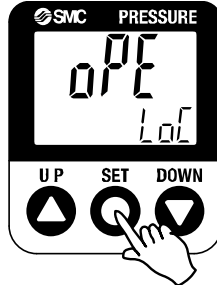

- (2) Select the un-locking [UnL] with UP or DOWN button. Setting is recognized by pressing the SET button, then security code is required.

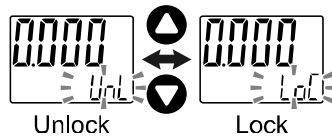

- (3) For instructions on how to enter the security code, refer to "How to input and change the security code" on page 57.

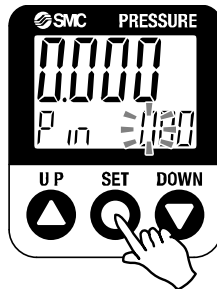

- (4) If inputted security code is correct, the indication of the main display changes to [UnL], and pressing the one of UP, SET or DOWN button releases key-lock and the measurement mode returns.  
If the security code entered is incorrect, [FAL] will be displayed, and the security code must be entered again. If the wrong security code is entered 3 times, [LoC] is displayed and the device returns to measurement mode.

● **How to input and change the security code**

The left most digit starts flashing.

Press the UP or DOWN button to select a value.

Press the SET button to make the next digit to the right flash.

(If the SET button is pressed at the last digit, the first digit will start flashing.)

After the setting is complete, Press and hold the SET button for 1 second or longer.

(If an operation is not performed for 30 seconds during input or change of the security code, it will return to measurement mode.)

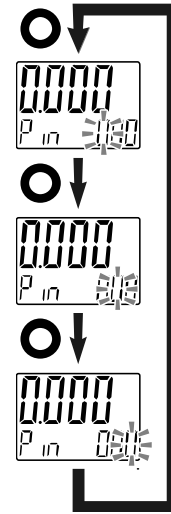

## Maintenance

### How to reset the product after a power cut or forcible de-energizing

The setting of the product will be retained as it was before a power cut or de-energizing. The output condition is also basically recovered to that before a power cut or de-energizing, but may change depending on the operating environment. Therefore, check the safety of the whole installation before operating the product. If the installation is using accurate control, wait until the product has warmed up (approximately 10 to 15 minutes).

## Forgotten the security code

Use the procedure below when the security code has been forgotten.

### <Operation>

Press the SET button for 5 seconds or longer in measurement mode. When [oPE] is displayed on the main display, release the button.

The current setting [LoC] or [UnL] will be displayed on the sub display.

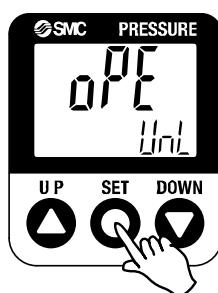

Press the UP and DOWN buttons simultaneously for 5 second or longer.

Press the SET and DOWN buttons simultaneously for 5 second or longer.

\*: Display is not changed.

(If another operation is performed or no operation is performed for 30 seconds, the display will return to measurement mode.)

Press the UP and SET buttons simultaneously for 5 second or longer.

Security code is displayed, and the security code change mode is available.

(If an operation is not performed for 30 seconds, the display will return to measurement mode.)



Decide on the security code referring to "How to input and change the security code" on page [57](#).

When input is completed, the selected security code flashes.

After checking the security code is as required, press the SET button for 1 second or longer.

Return to measurement mode.

At this time, if the UP or DOWN buttons are pressed, any security code changes are lost, and the change of security code must be repeated.

# Troubleshooting

## ○Troubleshooting

When any failure occurs with this product, the following chart can be used to identify the cause of the failure. If a cause applicable to the troubles cannot be identified and normal operation is recovered by replacement with a new product, this indicates that the product itself was faulty. Problems with the product may be due to the operating environment (installation etc). Please consult SMC.

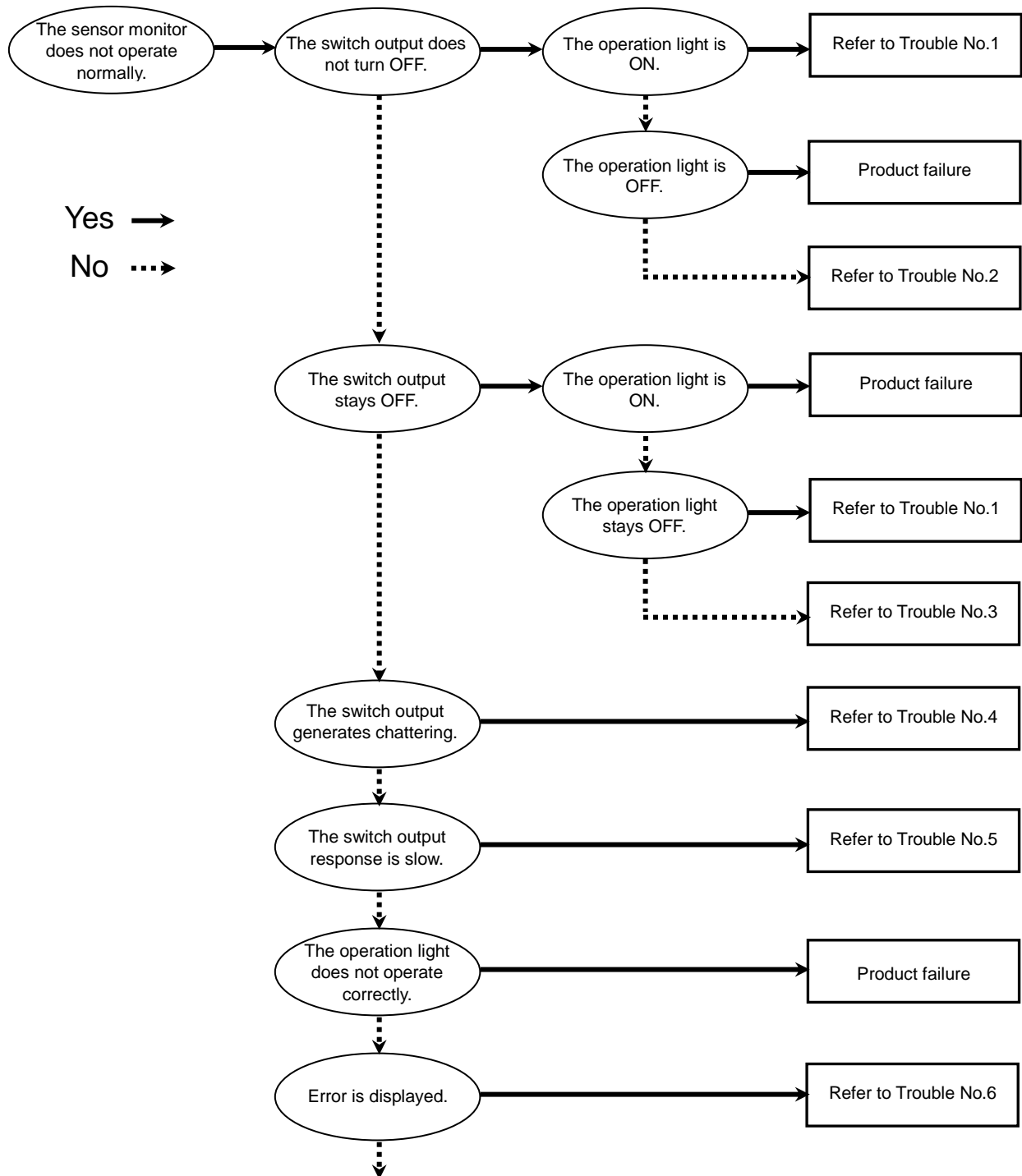

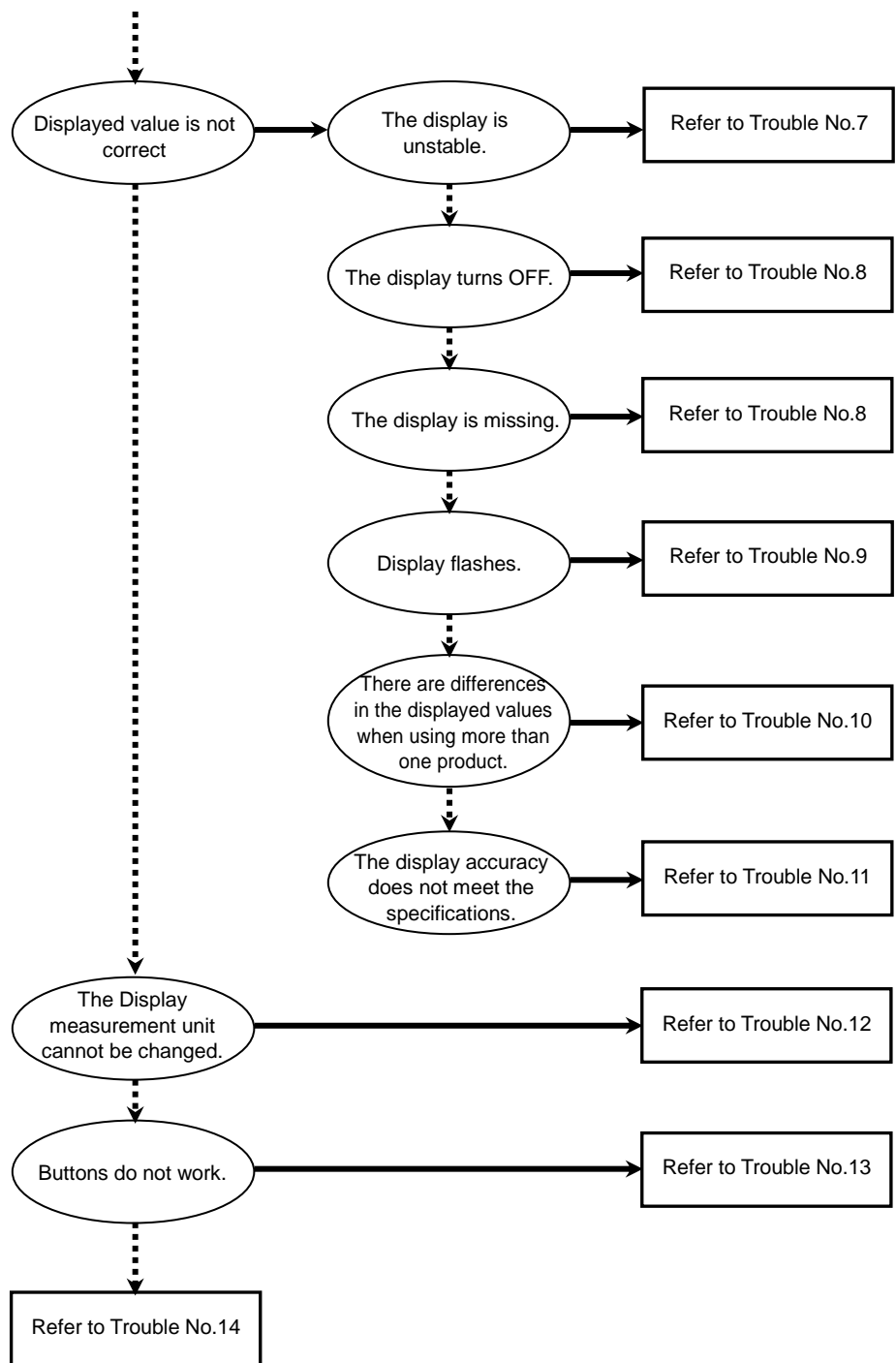

○Troubleshooting list

Problem No.	Problem	Problem possible causes	Investigation method	Countermeasures
1	<ul style="list-style-type: none"> <li>•The switch output does not turn OFF. The operation light stays ON.</li> <li>•The switch output does not turn ON. The operation light stays OFF.</li> </ul>	Incorrect pressure setting	(1) Check the set pressure value. (2) Check the settings of the operation mode, hysteresis and output type. (In hysteresis mode or window comparator mode, and normal output/ reversed output)	(1) Adjust the set pressure value. (2) Set the operation mode, hysteresis and output type again.
		Product failure		Replace the product.
2	The switch output does not turn OFF. The operation light is normal.	Incorrect wiring	Check the output wiring. Check if the load is directly connected to DC(+) or DC(-).	Check and correct the wiring.
		Product failure		Replace the product.
3	The switch output is OFF. The operation light is normal.	Incorrect wiring	Check the output wiring. Check if the load is directly connected to DC(+) or DC(-).	Check and correct the wiring.
		Incorrect SW output specification setting	Check the SW output specification setting. Check if the SW output is PNP while NPN is intended to be set, and vice versa.	Set the SW output specification again.
		Lead wire broken	Check if there is bending stress applied to any part of the lead wire. (bending radius, tensile force to the lead wire)	Correct the wiring. (Reduce the tensile force or increase the bending radius.)
		Product failure		Replace the product.
4	The switch output generates chattering.	Incorrect wiring	Check the wiring. Check if the brown and blue wires are connected to DC(+) and DC(-) respectively, and if the output line is secure (contact failure).	Correct the connection on the power cord and the plug.
		Incorrect pressure setting	(1) Check the set pressure value. (2) Check if the hysteresis range is small. (3) Check the delay time setting. Check if the delay time is too short.	(1) Adjust the set pressure value. (2) Make the hysteresis wider. (3) Set the delay time again.
		Product failure		Replace the product.
5	The switch output response is slow.	Incorrect pressure setting	Check the set pressure value. Check if the detected pressure and the set pressure values are the same or are too close.	Adjust the set pressure value. Ensure the set pressure value is not too close to the detected pressure value.

Problem No.	Problem	Problem possible causes	Investigation method	Countermeasures
6	<ul style="list-style-type: none"> <li>•Over current error (Er1, 2) is displayed.</li> <li>•System error (Er0, 4, 6, 7, 8, 9) is displayed.</li> <li>•"HHH" is displayed.</li> <li>•"LLL" is displayed.</li> <li>• Residual pressure error (Er3) is displayed.</li> </ul>	Excess current was applied to the output (Er1, 2)	<ol style="list-style-type: none"> <li>(1) Check if the current applied to the output has exceeded the maximum value.</li> <li>(2) Check if the connected load complies with the specification. Check if the load is short circuited.</li> <li>(3) Check if the relay without surge protection is connected.</li> <li>(4) Check if the wiring is in the same route as (or bundled together with) a high-voltage or power line.</li> </ol>	<ol style="list-style-type: none"> <li>(1)(2) Connect the appropriate load.</li> <li>(3) Use a relay with a surge voltage suppressor or take measures to prevent surge.</li> <li>(4) Separate the wiring from the high-voltage and/or power line.</li> </ol>
		Incorrect internal data processing of the product (Er0, 4, 6, 7, 8 and 9)	<ol style="list-style-type: none"> <li>(1) Check if there is noise interference (such as static electricity). Check if there is a noise source nearby.</li> <li>(2) Check if the power supply voltage is in the range 12 to 24 VDC.</li> </ol>	<ol style="list-style-type: none"> <li>(1) Remove the noise and the noise source (or take measures to prevent noise interference), and reset the product (or turn off and then turn back on the power supply).</li> <li>(2) Supply power in the range 12 to 24 VDC.</li> </ol>
		Applied pressure is higher than the upper limit (HHH)	<ol style="list-style-type: none"> <li>(1) Check if the pressure exceeds the upper limit of the set pressure range.</li> <li>(2) Check if foreign matter has entered the piping.</li> </ol>	<ol style="list-style-type: none"> <li>(1) Reset applied pressure to a level within the set pressure range.</li> <li>(2) Take measures to prevent foreign matter from entering the piping.</li> </ol>
		Applied pressure is lower than the lower limit (LLL)	<ol style="list-style-type: none"> <li>(1) Check if the pressure exceeds the lower limit of the set pressure range.</li> <li>(2) Check if foreign matter has entered the piping.</li> </ol>	<ol style="list-style-type: none"> <li>(1) Reset applied pressure to a level within the set pressure range.</li> <li>(2) Take measures to prevent foreign matter from entering the piping.</li> </ol>
		Pressure is not atmospheric pressure when zero-clear is performed (Er3)	Check if the pressure exceeded the atmospheric pressure within $\pm 7\%$ F.S.	Release the applied pressure to atmospheric pressure, and retry the zero clear operation.
		Product failure		Replace the product.
		7	The display is unstable.	Incorrect power supply
Incorrect wiring	Check the power supply wiring. Check if the brown and blue wires are connected to DC(+) and DC(-) respectively, and if the wiring is secure.			Check and correct the wiring.
Factory line pressure is not stable	Check if the factory line pressure is changing.			If the fluctuation is not acceptable, the number of digits (display sensitivity) can be reduced by changing the display resolution. Digital filter setting may improve the condition.



Problem No.	Problem	Problem possible causes	Investigation method	Countermeasures
8	<ul style="list-style-type: none"> <li>•The display turns OFF.</li> <li>•Part of the display is missing.</li> </ul>	Incorrect power supply	Check if the power supply voltage is in the range 12 to 24 VDC $\pm$ 10%.	Supply power in the range 12 to 24 VDC $\pm$ 10%.
		Incorrect wiring	Check the power supply wiring. Check if the brown and blue wires are connected to DC(+) and DC(-) respectively, and if the wiring is secure.	Check and correct the wiring.
		Power saving mode	Check if power saving mode is selected.	Select the power saving mode again.
		Product failure		Replace the product.
9	Display flashes.	Incorrect wiring	(1) Check the power supply wiring. (2) Check if there is bending stress applied to any part of the lead wire.	(1) Check and correct the wiring. (2) Correct the wiring (bend radius and stress).
10	Pressure display is unstable when products are in close proximity to each other.	Variation within the display accuracy range	Check if the variation is within the display accuracy range.	Use the fine adjustment mode to adjust the display if the variation is within the display accuracy range.
		Product failure		Replace the product.
11	The display accuracy does not meet the specifications.	Foreign matter entered	Confirmed foreign matter entry or sticking to the piping port.	Use 5 $\mu$ m of filter to prevent foreign matter from entering or sticking. Discharge the condensate of the filter periodically.
		Air or liquid leakage	Check if air or liquid are leaking from the piping.	Rework the piping. If the tightening torque is exceeded, the mounting screws, brackets and the product may be damaged.
		Warming up inadequate	Check if the product satisfies the specified accuracy 10 minutes after supplying power.	After energizing, the display and output can drift. For precise pressure detection, allow the product to warm up for 10 to 15 minutes.
		Product failure		Replace the product.
12	Display measurement unit cannot be changed.	Model selection (model selected does not have units selection function)	Check if the product number printed on the product indicates units selection function type.	Unit s selection function is not available for fixed to SI units type. (kPa $\leftrightarrow$ MPa is available) *: The units selection function is not for use in Japan due to a new measurement law. *: Fixed to SI units: kPa, MPa
		Product failure		Replace the product.



Problem No.	Problem	Problem possible causes	Investigation method	Countermeasures
13	Buttons do not work.	Key-lock mode is activated	Check if the key-lock function is turned on.	Check the key-lock function.
		Product failure		Replace the product.
14	The operation is unstable. (chattering)	Effect of line pressure fluctuation because hysteresis is too narrow or delay time of the switch is too short	(1) Check the set pressure values (hysteresis) (2) Check the delay time.	(1) Adjust the set pressure value. (2) Change the response time setting.
		Incorrect wiring/broken lead wire	(1) Check the power supply wiring. (2) Check if there is bending stress applied to any part of the lead wire. (bending radius, tensile force to the lead wire)	(1) Check and correct the wiring. (2) Correct the wiring. (Reduce the tensile force or increase the bending radius.)
		Product failure		Replace the product.

○Error indication function

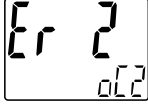
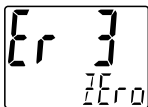
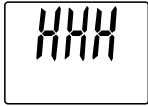
This function is to display error location and content when a problem or error has occurred.

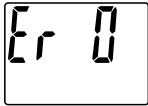
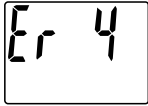
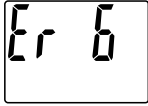
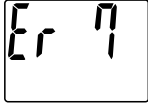
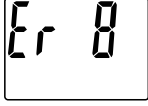
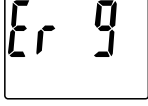
Error	Error displayed	Description	Measures
Over current error	 	The load current applied to the switch output has exceeded the maximum value.	Turn the power off and remove the cause of the over current. Then supply the power again.
Residual pressure error		During zero clear operation, pressure greater than $\pm 7\%$ F.S. is present. Note that the mode is returned to measurement mode automatically 1 second later. The zero clear range varies by $\pm 1\%$ F.S. due to variation between individual products.	Release the applied pressure to atmospheric pressure, and retry the zero clear operation.
Pressurizing error		Pressure exceeding the upper limit of the set pressure range is applied.	Reset applied pressure to a level within the set pressure range.
		Pressure exceeding the lower limit of the set pressure range is applied.	
System error	     	Displayed if an internal data error has occurred.	Turn the power off and on again. If the failure cannot be solved, contact SMC.

If the error cannot be reset after the above measures are taken, or errors other than above are displayed, please contact SMC.

# Specifications

Product No.		ISE70	ISE71	
Applicable fluid		Air, non-corrosive gas and non-flammable gas		
Pressure spec.	Rated pressure range	0 to 1.000 MPa	0 to 1.600 MPa	
	Display/set pressure range	-0.105 to 1.050 MPa	-0.105 to 1.680 MPa	
	Display/min. set unit	0.001 MPa		
	Proof pressure	1.5 MPa	2.4 MPa	
Electric spec.	Power supply voltage	12 to 24 VDC $\pm 10\%$ with 10% voltage ripple or less (p-p)		
	Current consumption	35 mA or less		
	Protection	Polarity protection		
Accuracy	Display accuracy	$\pm 2\%$ F.S. $\pm 1$ digit (at ambient temperature $25 \pm 3$ °C)		
	Repeatability	$\pm 0.5\%$ F.S.		
	Temperature characteristics	$\pm 2\%$ F.S. (25 °C standard)		
Switch output	Output type	Select from NPN or PNP open collector output.		
	Output mode	Select from hysteresis mode, window comparator mode, error output or switch output OFF.		
	Switch operation	Select from normal output or reversed output.		
	Maximum load current	80 mA		
	Maximum applied voltage	30 V (during NPN output)		
	Internal voltage drop (Residual voltage)	1.5 V or less (Load current 80 mA)		
	Delay time *1	1.5 ms or less (delay time available for anti-chattering function: Variable at 0 to 60 s/0.01 step)		
	Hysteresis	Hysteresis mode	Variable from 0 *2	
		Window comparator mode		
	Short circuit protection		Provided	
Display	Unit *3	MPa, kPa, kgf/cm <sup>2</sup> , bar, psi		
	Display type	LCD		
	Number of displays	3-screen display (Main display, sub display x 2)		
	Display colour	Main display: Red/Green, Sub display: Orange		
	Number of display digits	Main display: 4 digits (7-segments) Sub display: 4 digits (Upper 1 digit 11-segments, 7-segments for other)		
	Operation light	LED is ON when switch output is ON (OUT1, OUT2: Orange)		
Digital filter *4		Variable at 0 to 30 s/0.01 step		

Product No.		ISE70	ISE71
Environment	Enclosure	IP67	
	Withstand voltage	1000 VAC for 1 minute between terminals and housing	
	Insulation resistance	50 MΩ or more between terminals and housing (with 500 VDC megger)	
	Ambient temperature range	Operation: 0 to 50 °C, Storage: -10 to 60 °C (No condensation or freezing)	
	Operating humidity range	Operation, Storage: 35 to 85%RH (No condensation)	
Standard		UL/CSA(E216656), CE, RoHS	

\*1: Value without digital filter (at 0 ms).

\*2: If the applied pressure fluctuates around the set value, the hysteresis must be set to a value more than the amount of fluctuation or chattering will occur.

\*3: This setting is only available for models with the units selection function.  
Only MPa, kPa or Pa is available for models without this function.

\*4: The response time indicates when the set value is 90% in relation to the step input.

\*5: Any products with tiny scratches, smears, or display colour variation or brightness which does not affect the performance are verified as conformant products.

#### ○Piping/weight specifications

Product No.		02	N02	F02
Port size		Rc1/4	NPT1/4	G1/4
Materials in fluid contact part	Pressure-sensing part	Silicon		
	Piping port	C3604 (Electroless nickel plating), HNBR		
Weight	Body	153 g	152 g	150 g
	Lead wire with M12 connector	139 g		

## ■Dimensions

- Dimensions of main unit

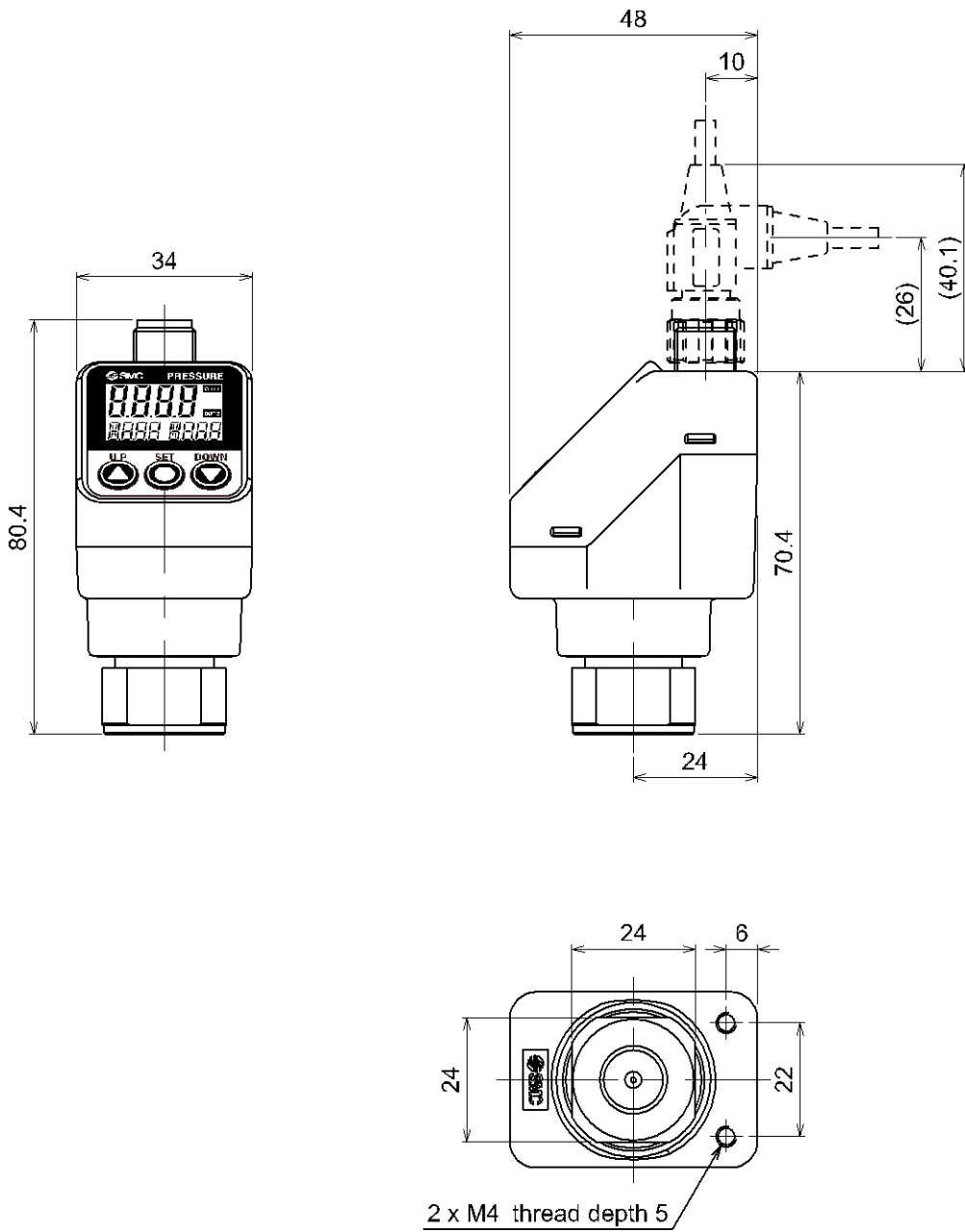

•Bracket A

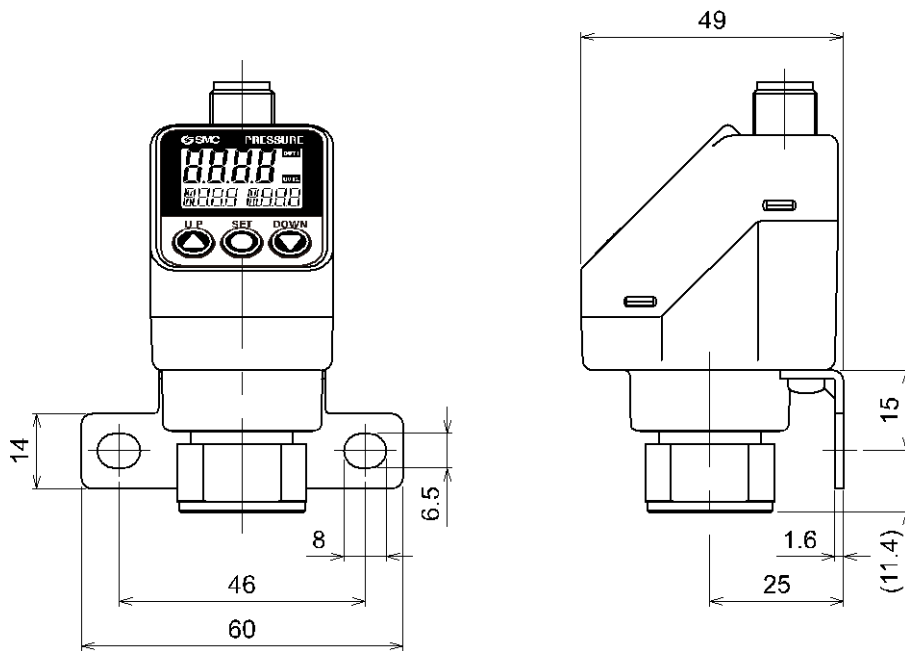

•Bracket B

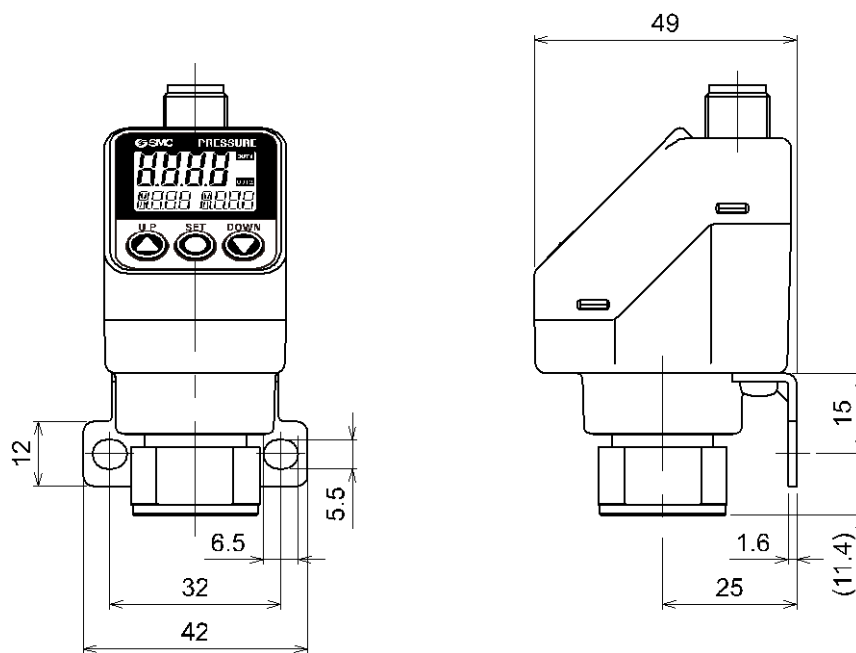

○Lead wire with M12 connector

•ZS-31-B

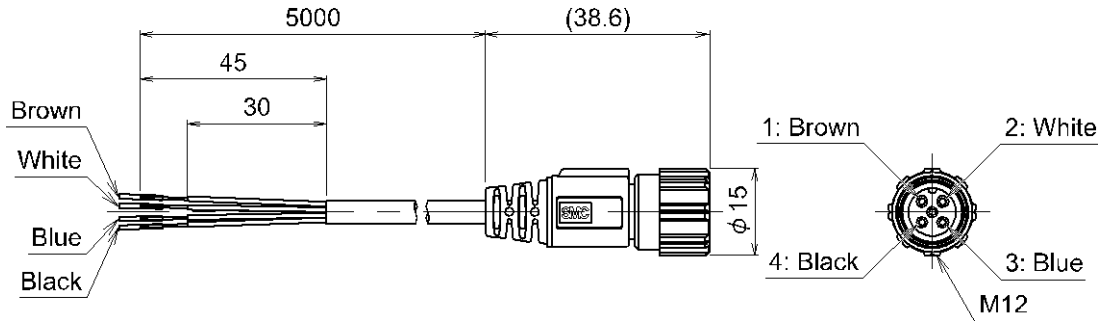

•ZS-31-C

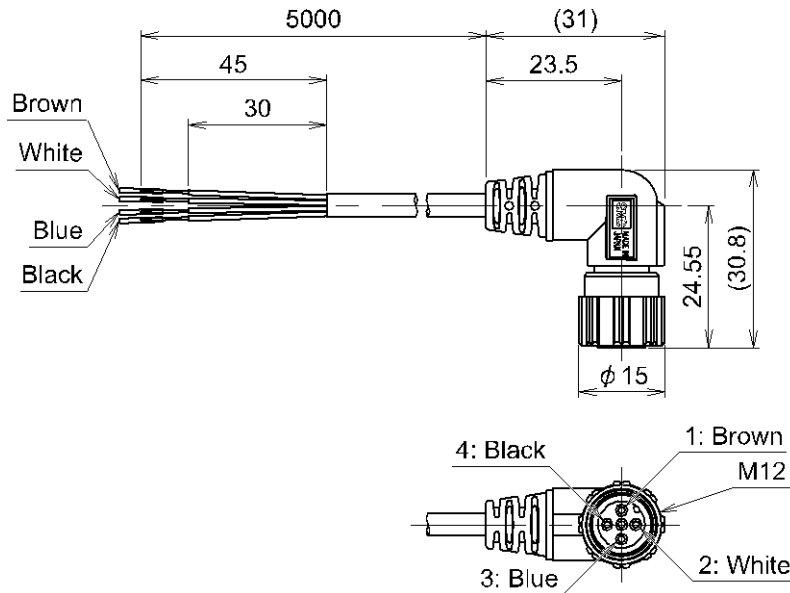

○Cable specifications

Conductor	Nominal crosssection area	AWG23
	Outside diameter	0.72 mm
Insulator	Material	Crosslinked vinyl chloride
	Outside diameter	1.14 mm
	Colours	Brown, Blue, Black, White
Sheath	Material	Oil resistant vinyl chloride
Finished outside diameter		φ4
Length		5 m

#### Revision history

A: Contents revised in several places.  
[October 2018]

## SMC Corporation

4-14-1, Sotokanda, Chiyoda-ku, Tokyo 101-0021 JAPAN

Tel: + 81 3 5207 8249 Fax: +81 3 5298 5362

URL <http://www.smcworld.com>

---

Note: Specifications are subject to change without prior notice and any obligation on the part of the manufacturer.  
© 2018 SMC Corporation All Rights Reserved.

