

Analog Auto Switch and Display Sensor Monitor



New

RoHS

IP67

* Analog auto switch only

Outputs the analog voltage according to the actuator stroke position



A single switch can discriminate between max. 3 position points.

Discriminable resolution: ± 0.1 mm

* Within the high-resolution range

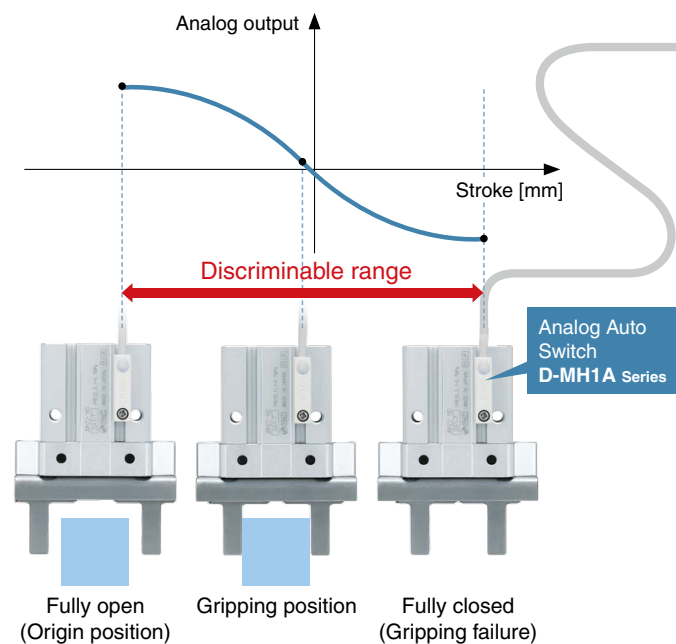

Detection position setting can be done away from the actuator.

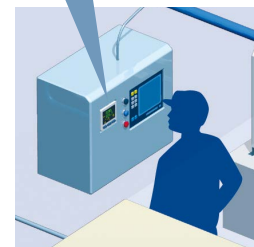
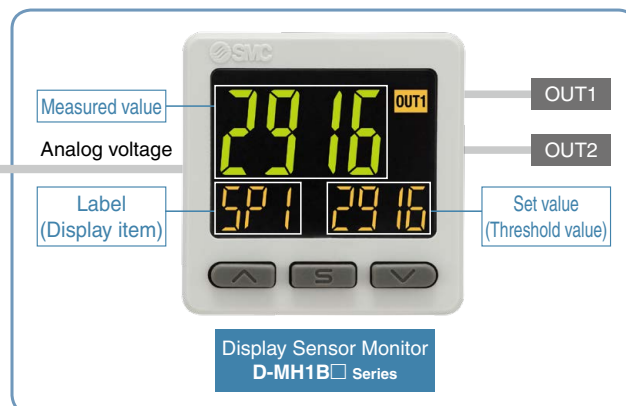

■ Analog voltage output (1 to 5 V)

· Can also be used with the analog auto switch single unit

■ Reduced setting labor

- No need to fine-tune the switch mounting position
- Easy adjustment even in narrow places and on moving parts

■ Improved productivity

- Gripper fully open → gripping → gripping failure detection
- Detection of gripper finger wear
- Minimized lead wire disconnection risk

D-MH1 □ Series



CAT.ES20-299A

Reduced switch mounting and setting labor

Item	Existing auto switch		New Analog Auto Switch and Display Sensor Monitor	
Number of switches	2 pcs.		1 pc.	
Mounting	2 pcs.		1 pc.	
Setting/Adjustment	2 pcs. (Fine-tuning of the detection positions required)		1 pc. (Setting and adjusting 2 to 3 positions is possible with the display sensor monitor snapshot function)	
Wiring	2 pcs.		1 pc.	
Switch cable	2 cables		1 cable	

Snapshot function for easy switch output setting Reduced setting labor

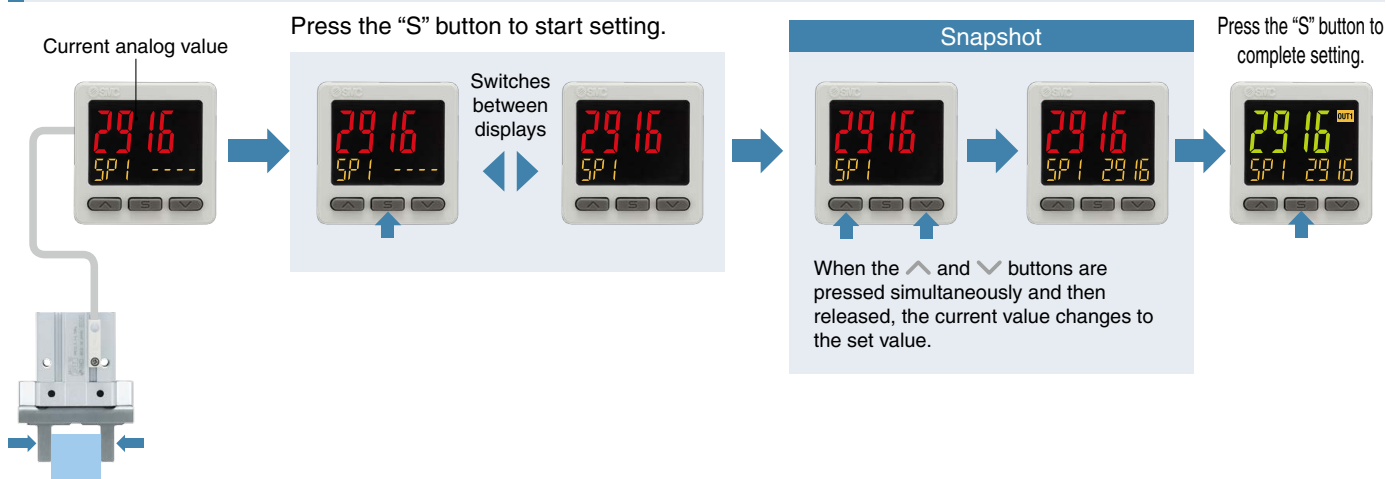

No protrusion from the air gripper body end surface

Existing auto switch

With protrusion from the air gripper
(For both the in-line type and the perpendicular type wiring entries)

Wiring entry: In-line type

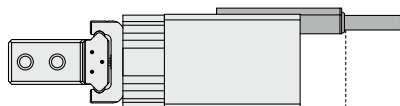

Wiring entry: Perpendicular type

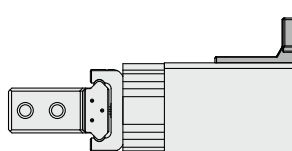

← Protrusion

New Analog Auto Switch and Display Sensor Monitor

No protrusion from the air gripper
(Easy axial mounting for the perpendicular type wiring entry)

Wiring entry: In-line type

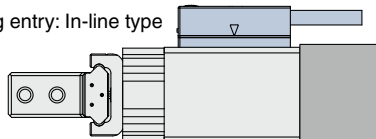

Wiring entry: Perpendicular type

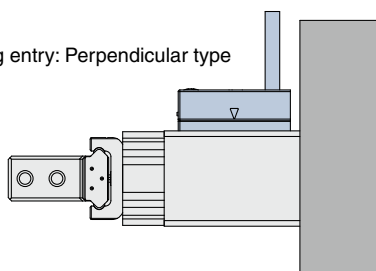

No protrusion
→ Easy axial mounting

Improved productivity: The setting mode can be changed to allow for a wide range of uses.

By selecting either the 3-setting mode or the 2-setting mode, various uses can be accommodated and productivity can be improved.

3-setting mode usage example

- Confirmation of the origin/gripping position + erroneous gripping (closed position)

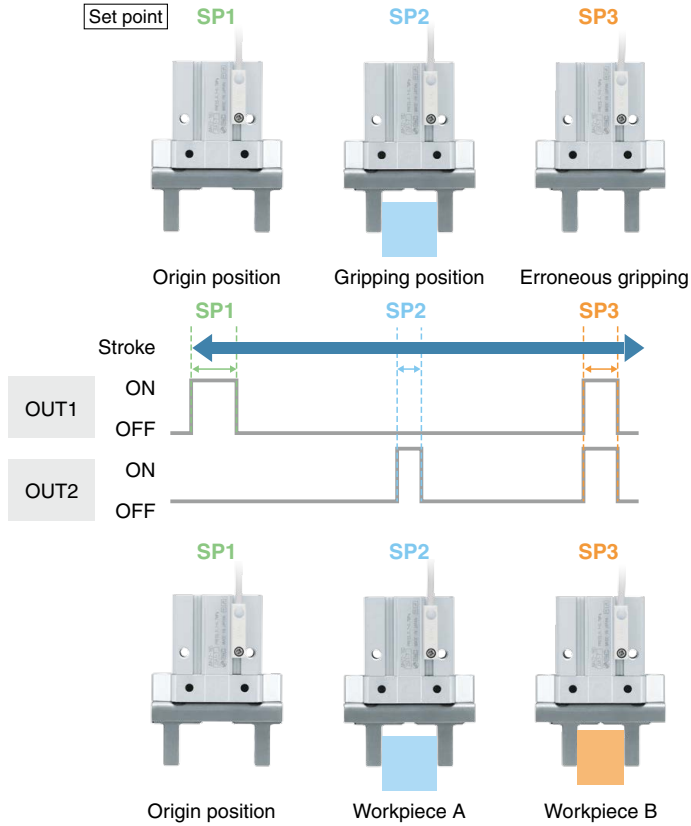

3-setting mode		
Set point	Output terminal	
	OUT1	OUT2
SP1	ON	OFF
SP2	OFF	ON
SP3	ON	ON

* SP3 is set to OUT1 + OUT2 simultaneous output.
 * In 3-setting mode, it is not possible to set the output range to overlap.

2-setting mode usage example

- Origin/Gripping position

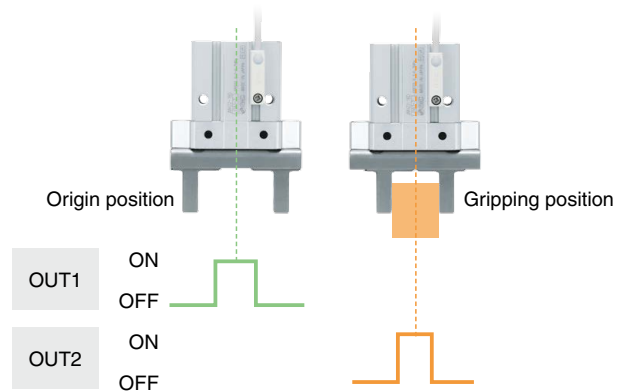

- Simple workpiece recognition

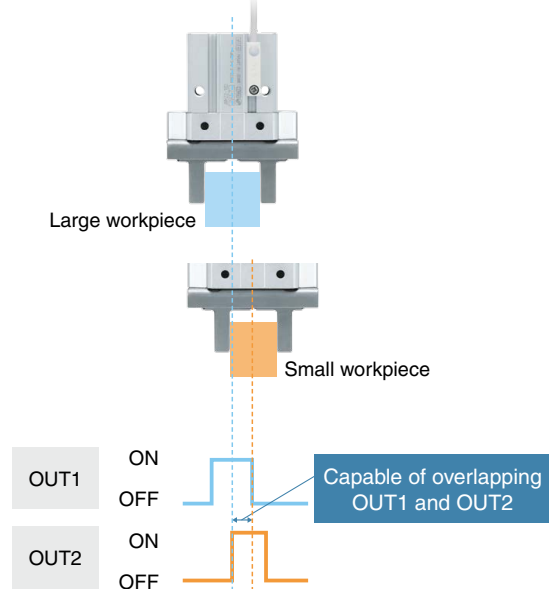

Improved productivity: Easy resetting due to position shifting

The switch output's output range and hysteresis can be set.

The ON width and hysteresis can be changed via the display sensor monitor.

(It is possible to set SP1 to 3 individually.)

The ON width can be used to change the switch output's ON range. Chattering of the switch output can be prevented by setting a hysteresis.

Relationship between the set point and the output terminal
 (For 3-setting mode)

Set point	Output terminal	
	OUT1	OUT2
SP1	ON	OFF
SP2	OFF	ON
SP3	ON	ON

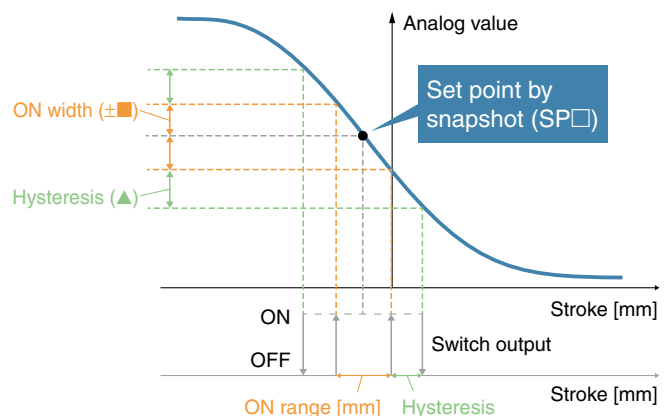

Improved productivity: Visualization of tool (attachment) wear

1 The switch analog signal can be used to detect changes in the signal during a given process.

(Example) You can check the value when the master workpiece is gripped and detect changes over time.

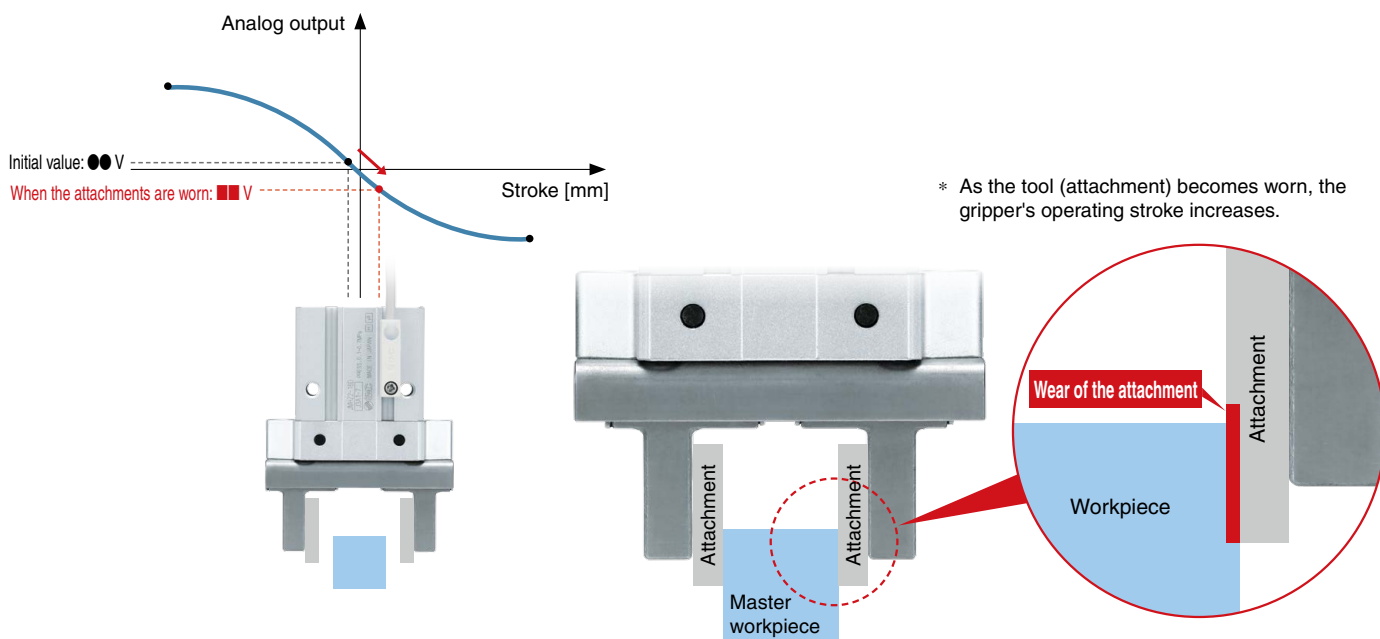

2 The difference between the measured value and the threshold value can be displayed using the function provided on the display sensor monitor.

(Example) When the value at which the master workpiece is gripped is set as the threshold value, the difference can be checked each time.

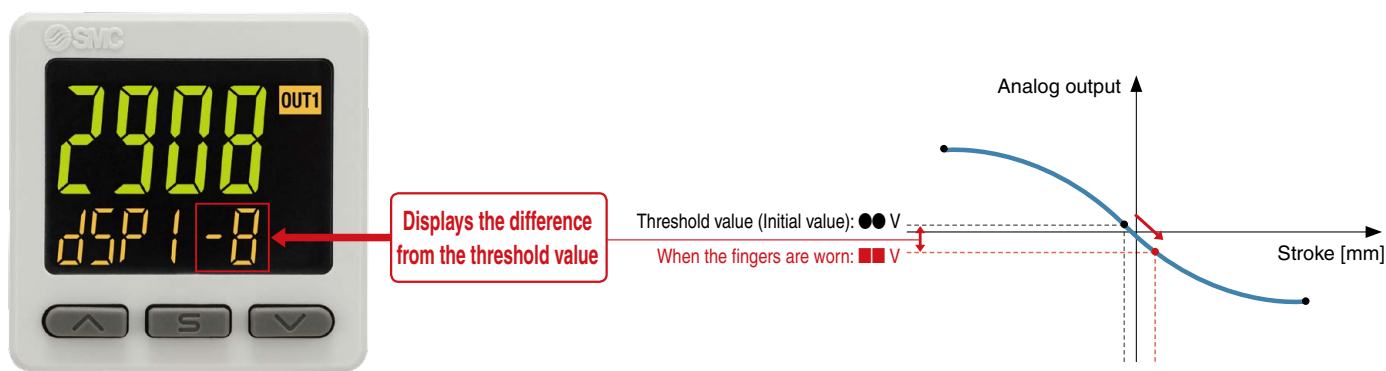

CONTENTS

Analog Auto Switch *D-MH1AD* Series

How to Order	p. 4
Specifications	p. 4
Weight	p. 4

Display Sensor Monitor *D-MH1B*□ Series

How to Order	p. 5
Specifications	p. 5
Weight	p. 5

Internal Circuits and Wiring	p. 6
Dimensions	p. 6
Applicable Actuators and Analog Auto Switch Mounting	p. 9
Specific Product Precautions	p. 13
Safety Instructions	Back cover

Analog Auto Switch and Display Sensor Monitor



D-MH1□ Series

IP67

* Analog auto switch only

How to Order Analog Auto Switches

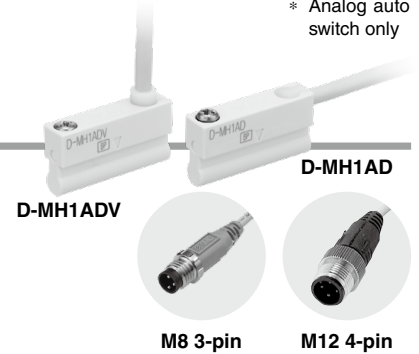
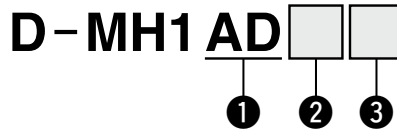

1 Product category

AD	Analog output sensor (1 to 5 V)
-----------	---------------------------------

2 Electrical entry

Nil	In-line
V	Perpendicular

3 Lead wire specification

Nil	0.5 m, Separate line	SAPC	M8 3-pin connector, 0.5 m
M	1 m, Separate line	MAPC	M8 3-pin connector, 1 m
L	3 m, Separate line	SBPC	M8 4-pin connector, 0.5 m
Z	5 m, Separate line	MBPC	M8 4-pin connector, 1 m
		SDPC	M12 4-pin connector, 0.5 m
		MDPC	M12 4-pin connector, 1 m

* The D-MH1□ cannot be ordered with the cylinder or actuator. It must be ordered separately.

* Connector specifications "SAPC" to "MDPC" cannot be selected for use with the D-MH1B display sensor monitor. In addition, when connecting to the D-MH1B display sensor monitor, a separate sensor connector (option) is required.

Specifications

Analog Auto Switch

Model	D-MH1AD(V)
Power supply voltage	12 to 24 VDC ±10%, Ripple (p-p) 10% or less (with power supply polarity protection)
Current consumption	10 mA or less
Output specifications	Analog voltage output 1 to 5 V
Output impedance	Approx. 1 kΩ
Output repeatability (Ambient temperature: 25°C)	±20 mV*1
Output temperature characteristics (25°C standard)	±80 mV (-10 to 60°C)*2
Operating time	1 ms or less
Electrical entry	Grommet
Impact resistance	1000 m/s ²
Insulation resistance	50 MΩ or more (500 VDC measured via megohmmeter)
Withstand voltage	1000 VAC for 1 min (Between the lead wire and case)
Ambient temperature	-10 to 60°C
Enclosure	IP67
Standards	CE/UKCA marking

*1 Single switch unit characteristics. When the mounting orientation is uniform and there is no magnetic body or magnetic field disturbance in the surroundings.

Excluding a deformation of the workpiece or wobbling of the actuator

*2 Single switch unit characteristics. The effect of fluctuations in the magnetic force of the magnet itself is excluded.

· Do not apply a strong magnetic field exceeding 200 [mT] to the sensor. Doing so may result in malfunction or accuracy degradation of the analog auto switch. Doing so may also cause abnormal operation.

Oilproof Flexible Heavy-duty Lead Wire Specifications

Model	D-MH1AD(V)	
Sheath	Outside diameter [mm]	ø2.6
	Number of cores	3 cores (Brown/Black/Blue)
Insulator	Outside diameter [mm]	ø0.88
	Effective area [mm ²]	0.15
Conductor	Strand diameter [mm]	ø0.05
	Min. bending radius (Reference value)	17

Weight

Model	D-MH1AD (V) [g]
0.5 m (Nil)	8
1 m (M)	14
3 m (L)	41
5 m (Z)	68

Connector Weight

Connector type	Weight
M8-3pin (APS)	4 g
M8-4pin (BPC)	4 g
M12-4pin (DPC)	Approx. 11 g

* When a connector is selected, add the above weight.

How to Order Display Sensor Monitors

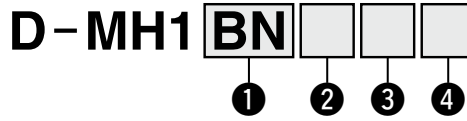

1 Product category

BN	Display sensor monitor, NPN 2 outputs
BP	Display sensor monitor, PNP 2 outputs

2 Option 1

Symbol	Description
Nil	Without lead wire
L	Lead wire with connector (2 m lead wire)

* A lead wire with a connector is required for power supply input.

4 Option 3

Symbol	Description
Nil	None
C	Sensor connector

* A sensor connector is required to connect the sensor to the display sensor monitor.

3 Option 2

Symbol	Description
Nil	None
A	Bracket
B	Panel mount adapter
D	Panel mount adapter + Front protection cover

Specifications

Display Sensor Monitor

Model		D-MH1B
Applicable sensor		D-MH1AD(V)
Rated pressure range		1000 to 5000 mV
Display and set range		800 to 5200 mV
Display and smallest settable increment		2 mV
Electrical specifications	Power supply voltage	12 to 24 VDC $\pm 10\%$, Ripple 10% or less (with power supply polarity protection)
	Current consumption	35 mA or less
Accuracy	Display accuracy	± 20 mV ± 1 digit (Ambient temperature: Constant at 25°C)
	Repeatability	± 4 mV ± 1 digits
	Temperature characteristics	± 20 mV (25°C standard)
Switch output	Output specifications	Select from NPN or PNP open collector 2 outputs.
	Output mode	Select from 2-setting mode or 3-setting mode.
	Switch operation	Select from normal output or reversed output.
	Max. load current	80 mA
	Max. applied voltage (NPN only)	30 VDC
	Internal voltage drop (Residual voltage)	NPN: 1 V or less (at load current of 80 mA) PNP: 1.5 V or less (at load current of 80 mA)
	Delay time*1	1.5 ms or less (Anti-chattering function: can be set to 0.00 to 5.00 s) (Smallest settable increment: 0.01 s)
	Hysteresis	Variable from 0 (Initial value: 20 mV)
Sensor input	Protection	Over current protection
	Input type	Voltage input 1 to 5 VDC (Input impedance: 1 M Ω)
	Number of inputs	1 input
	Connection method	Connector (e-CON)
Display	Protection	Over voltage protection (up to a voltage of 26.4 V)
	Display type	LCD
	Number of screens	3-screen display (Main screen, Sub screen x 2)
Digital filter*2, *3	Display color	Main screen: Red/Green Sub screen: Orange
		0, 10, 50, 100, 500, 1000, 5000 ms
Environmental resistance	Enclosure	IP40
	Withstand voltage	1000 VAC for 1 min between terminals and housing
	Insulation resistance	50 M Ω or more (500 VDC measured via megohmmeter) between terminals and housing
	Operating temperature range	Operating: 0 to 50°C, Stored: -10 to 60°C (No freezing or condensation)
Standards	Operating humidity range	Operating/Stored: 35 to 85% RH (No condensation)
		CE/UKCA marking

Weight

	[g]
Body (D-MH1B) (Excludes power supply and output lead wires)	25
Lead wire with connector	39

*1 Value without digital filter (at 0 ms)

*2 The response time indicates when the set value is 90% in relation to the step input.

*3 Display, switch output and analog response time are affected.

Internal Circuits and Wiring

Analog auto switch

Voltage output type
1 to 5 V
Output impedance
Approx. 1 k Ω

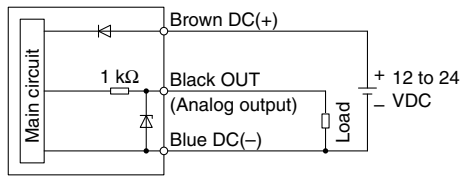

Sensor Connector Specifications

Pin no.	Voltage input
1	DC (+) (Brown)
2	N.C.
3	DC (-) (Blue)
4	IN (1 to 5 V) (Black)

Display sensor monitor

NPN (2 outputs) setting

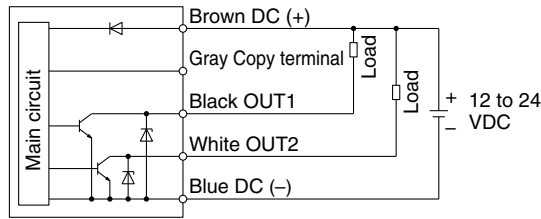

PNP (2 outputs) setting

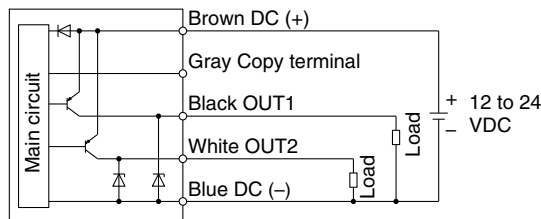

M8/M12 Connector Specifications

Pin no.	Voltage input
1	DC (+) (Brown)
2	N.C.
3	DC (-) (Blue)
4	IN (1 to 5 V) (Black)

Connector type	M8 3-pin	M8 4-pin	M12 4-pin
Pin arrangement			

Dimensions

Analog auto switch

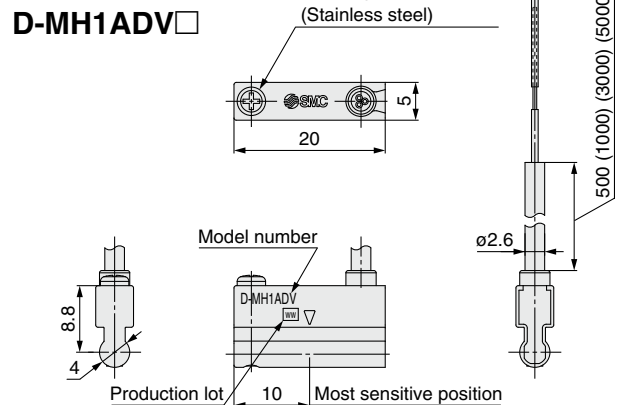
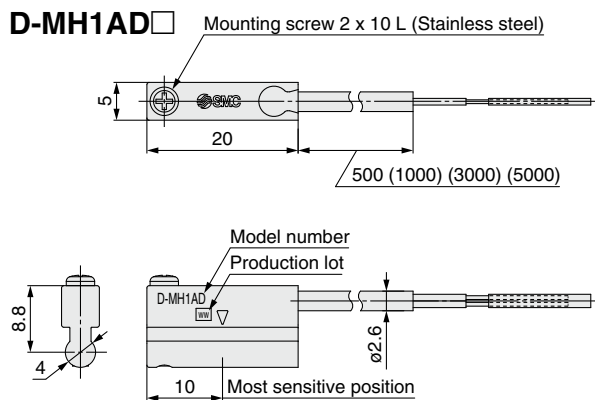

M8/M12 connector (D-MH1AD□□PC)

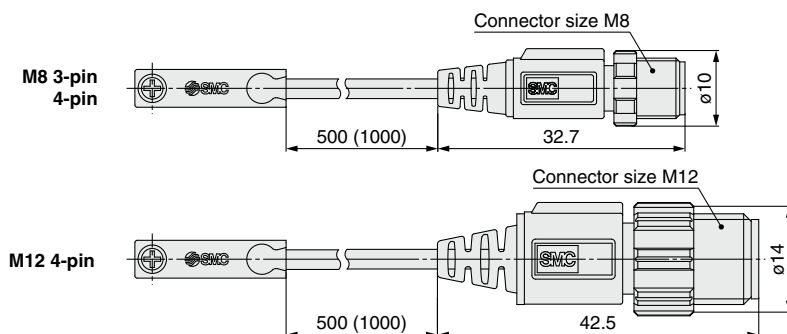

D-MH1□ Series

Dimensions

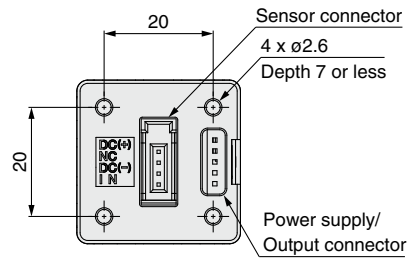
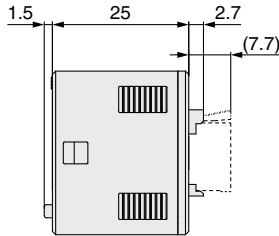
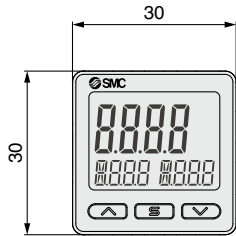
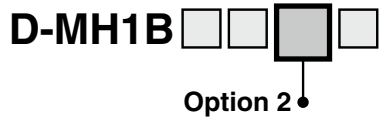

A

Bracket
(Part no.: ZS-46-A1)

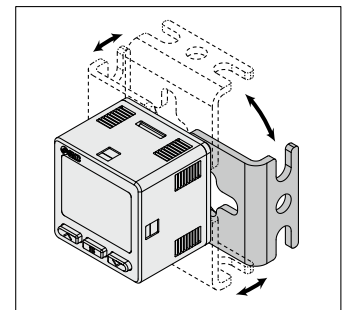
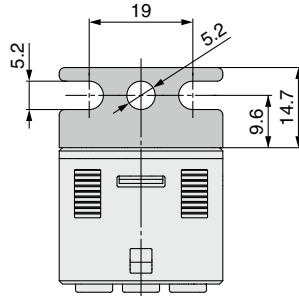
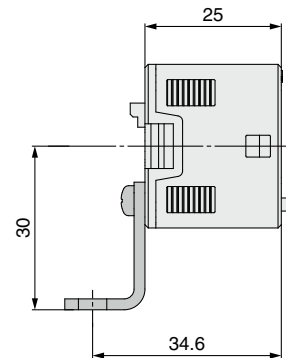
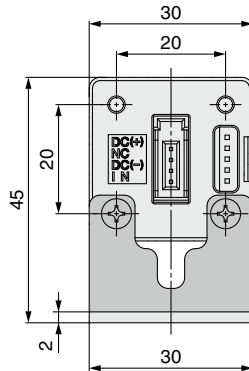

B

Panel mount adapter
(Part no.: ZS-46-B)

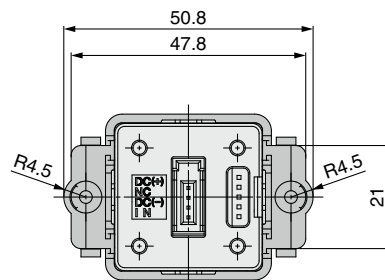
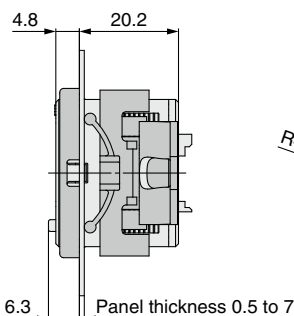
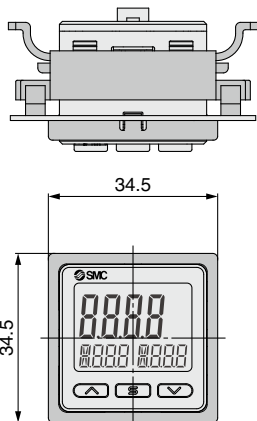

* The bracket configuration allows for mounting in four orientations.

Dimensions

D

Panel mount adapter + Front protection cover
(Part no.: ZS-46-D)

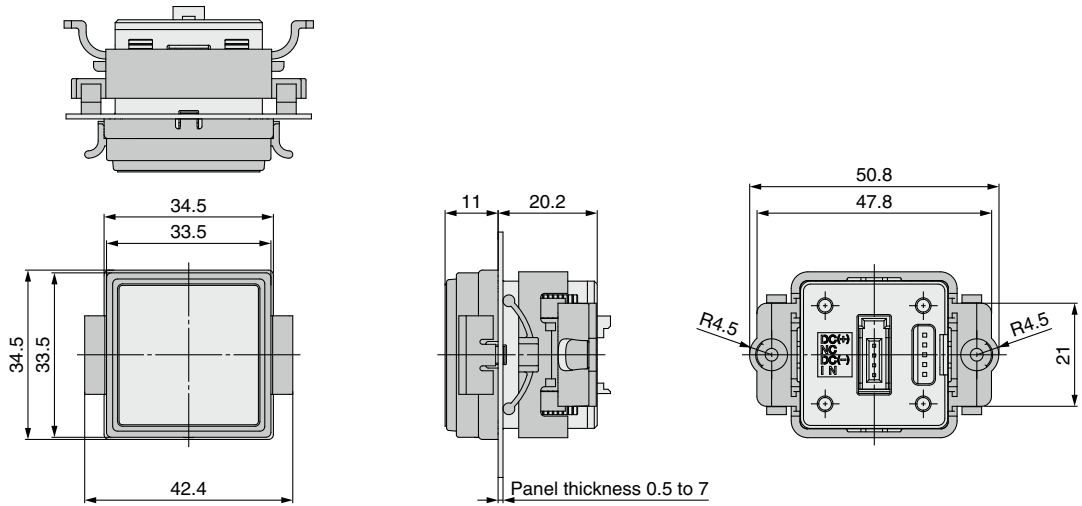

Lead wire with connector
(Part no.: ZS-46-5L)

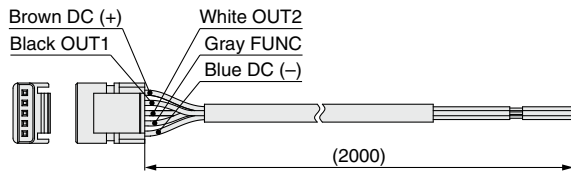

Cable Specifications

Conductor cross section	0.15 mm ² (AWG26)	
Insulator	O.D.	1.0 mm
	Color	Brown, Blue, Black, White, Gray (5-core)
Sheath	Finished O.D.	ø3.5

D-MH1□ Series

Applicable Actuators and Analog Auto Switch Mounting

1. Full-stroke detectable actuator

Position detection can be performed at the full stroke position by mounting the analog auto switch at the recommended mounting B dimension.

<Recommended mounting B dimension>

Position so that the middle position of the finger aligns with the center of the sensor (3 V).

Fully open position Mounting at the recommended mounting B dimension Fully closed position

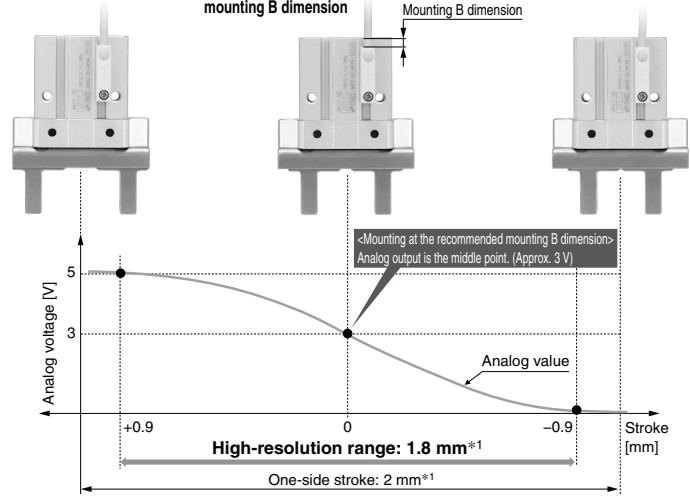

*1 When mounted on an MHZ2 (ø6) air gripper

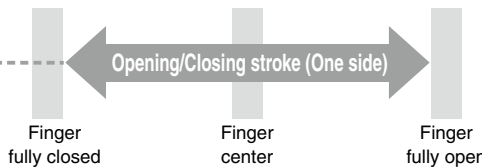
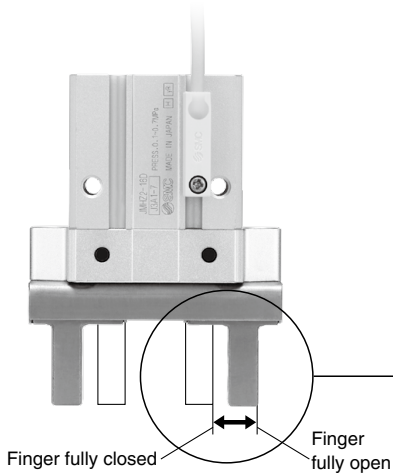

Series/Mounting	Bore size [mm]	Opening/Closing stroke [mm]	
		Both sides	One side
JMHZ2	12	6	3
MHZ2/ MHZJ2	Round groove	6	4
		10	4
		16	6
	Square groove	20	10
		10	4
		16	6
MHF2(D)	8	8	4
MDHR3	10	6	3
MHK2	12	4	2
	16	6	3
MHS2/MHS4	16	4	2
	20	4	2
	25	6	3
	32	8	4
MHS3/ MHSJ3 ø16 to ø25/ MHSJ3 ø16 to ø25/ MHSJ3 ø16 to ø25	16	4	2
	20	4	2
	25	6	3
	32	8	4
MHSJ3 MHSJ3 MHSJ3	32	8	4
	40	8	4
	50	12	6
MHC2	10	—	—
	16	—	—
	20	—	—
	25	—	—

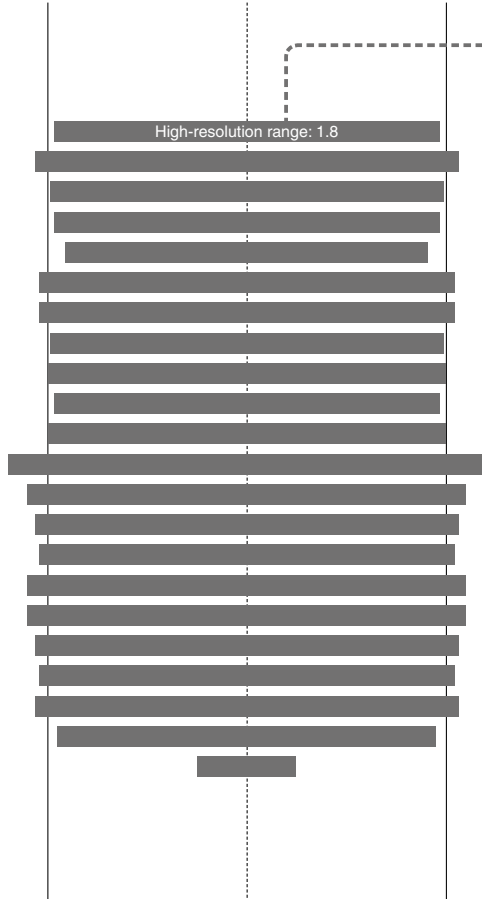

High-resolution range [mm]	Recommended mounting B dimension [mm]	Note
—	1.7	
1.8	1.1	
2.3	0.7	MHZJ2 only
3.1	6.8	
4.8	9.7	
1.5	2.3	MHZ2 only
3.2	6.8	MHZ2 only
5.2	9.9	MHZ2 only
3.9	3.2	Short type only
3.0	11.7	
1.8	6.2	
3.0	6.0	
3.1	3.7	
2.7	4.8	
3.5	6.5	
4.4	8.1	
2.7	3.9	
2.7	4.8	
3.5	6.5	
4.4	8.1	MHS3 only
4.5	7.3	
3.7	8.1	
2.0	11.0	
Angle open/ close type	1.2	
	3.3	
	5.2	
	6.7	

* All the above values are reference values.

* There is a possibility of the above values fluctuating significantly depending on the ambient environment. Be sure to conduct a test operation in the actual operating environment.

* The displayable magnetic force range may be exceeded depending on the mounting position. For details, contact SMC.

Mounting position

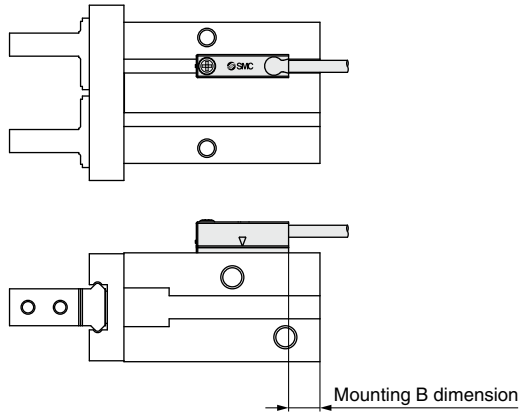

How to Mount

<For square groove mounting>

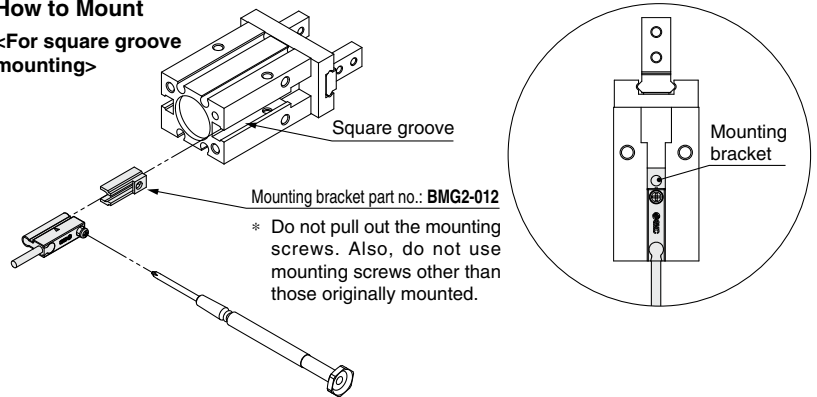

Mounting bracket part no.: **BMG2-012**

* Do not pull out the mounting screws. Also, do not use mounting screws other than those originally mounted.

Tightening torque: About 0.15 to 0.25 N·m

* Use a #0 Phillips head screwdriver.

[High-resolution range with a short stroke]

The high-resolution range is a guide for the range in which the product can discriminate between workpiece differentials of ± 0.1 mm. When the switch is mounted at the recommended mounting B dimension, the high-resolution range will be the range centered around the approx. 3 V point of the center of the analog output. (For grippers, this is the value for one side of the finger. When it is converted to the dimension of the workpiece to be gripped, the value is doubled.) Refer to the operation manual for a detailed explanation of resolution.

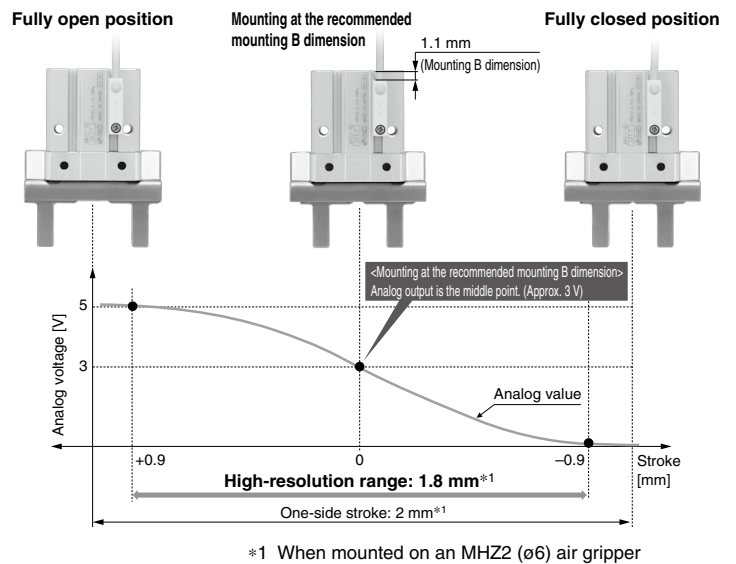

● If the workpiece dimension is changed, the analog output will also change. However, if it is mounted at the recommended mounting B dimension, an actuator that can detect full strokes can detect the full stroke position, and the position can be detected at high resolution within the range centered around the recommended mounting B dimension.

D-MH1□ Series

2. Actuator with long stroke

There will be a point where the analog output crosses the peak/bottom and the same analog value is output. By mounting the analog auto switch at the recommended mounting dimension, position detection can be made within the “discriminable range,” which is defined as the range between the peak and the bottom of the analog output.

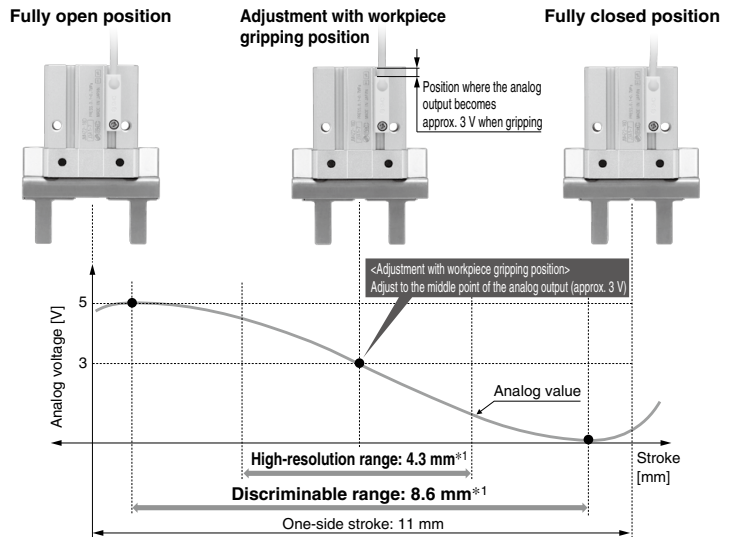
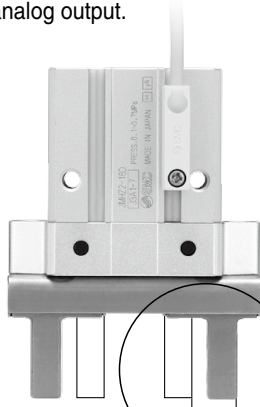

*1 When mounted on an MHZ2 (ø32, round groove) air gripper

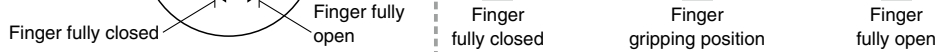

Series/Mounting	Bore size [mm]	Opening/Closing stroke [mm]	
		Both sides	One side
JMhZ2	16	10	5
	20	14	7
MHZ2	Round groove	25	14
		32	22
		40	30
	Square groove	25	14
		32	22
		40	30
MHZL2	Round groove	16	12
		20	18
		25	22
	Square groove	10	8
		16	12
		20	18
MHF2 (D/D1/D2)	8	32 (D2)	16 (D2)
	12	48 (D2)	24 (D2)
	16	64 (D2)	32 (D2)
	20	80 (D2)	40 (D2)
MHZJ2	25	14	7
	32	22	11
	40	30	15
MHL2-Z (D/D1/D2)	10	20 (D)	10 (D)
	16	30 (D)	15 (D)
	20	40 (D)	20 (D)
	25	50 (D)	25 (D)
	32	70 (D)	35 (D)
MDHR2	30	18	9
	40	25	12.5
MHKL2	12	11	5.5
	16	14	7
	25	22	11
MHK2 ø25	25	14	7
MHS2/MHS4	63	16	8
	80	20	10
MHS3	63	16	8
	80	20	10
	100	24	12
MHS3	125	32	16

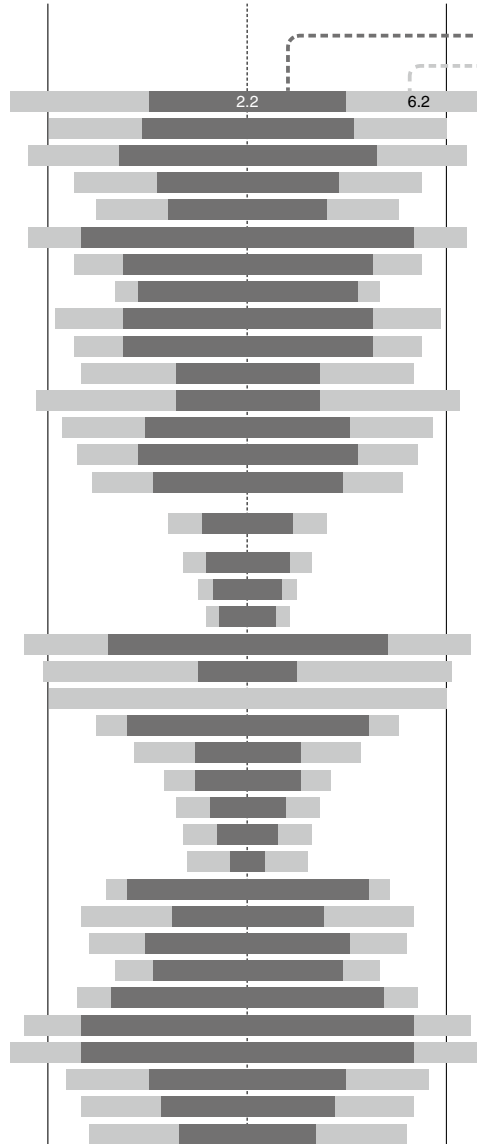

High-resolution range [mm]	Discriminable range [mm]	Note
2.2	6.2	
3.2	7.0	
4.2	7.9	
4.3	8.6	
4.9	8.8	
5.2	8.0	
5.7	8.3	
6.4	8.8	
3.1	5.7	
4.8	7.0	
4.2	7.9	
1.5	4.3	
3.2	5.4	
5.2	7.2	
5.2	8.0	
2.9	5.6	Excludes the short type
3.8	5.8	
3.5	5.7	
2.8	5.9	
4.2	7.9	
2.9	11.3	
—	15.3	
5.0	6.9	
3.9	6.7	
5.2	7.2	
4.5	7.1	
4.4	9.1	
2.8	12.1	
4.3	5.2	
1.8	4.3	
3.0	5.1	
4.0	5.8	
4.0	5.8	
6.4	9.0	
6.4	9.5	
6.0	9.1	
6.2	9.5	
6.3	11.7	

- * All the above values are reference values.
- * The discriminable range is the range between the peak and the bottom of the analog output. (One side of the gripper)
For details, refer to the operation manual of the product.
- * There is a possibility of the above values fluctuating significantly depending on the ambient environment. Be sure to conduct a test operation in the actual operating environment.
- * Refer to the operation manual for details on how to determine the mounting position of other switches.

Applicable Actuators and Analog Auto Switch Mounting **D-MH1** Series

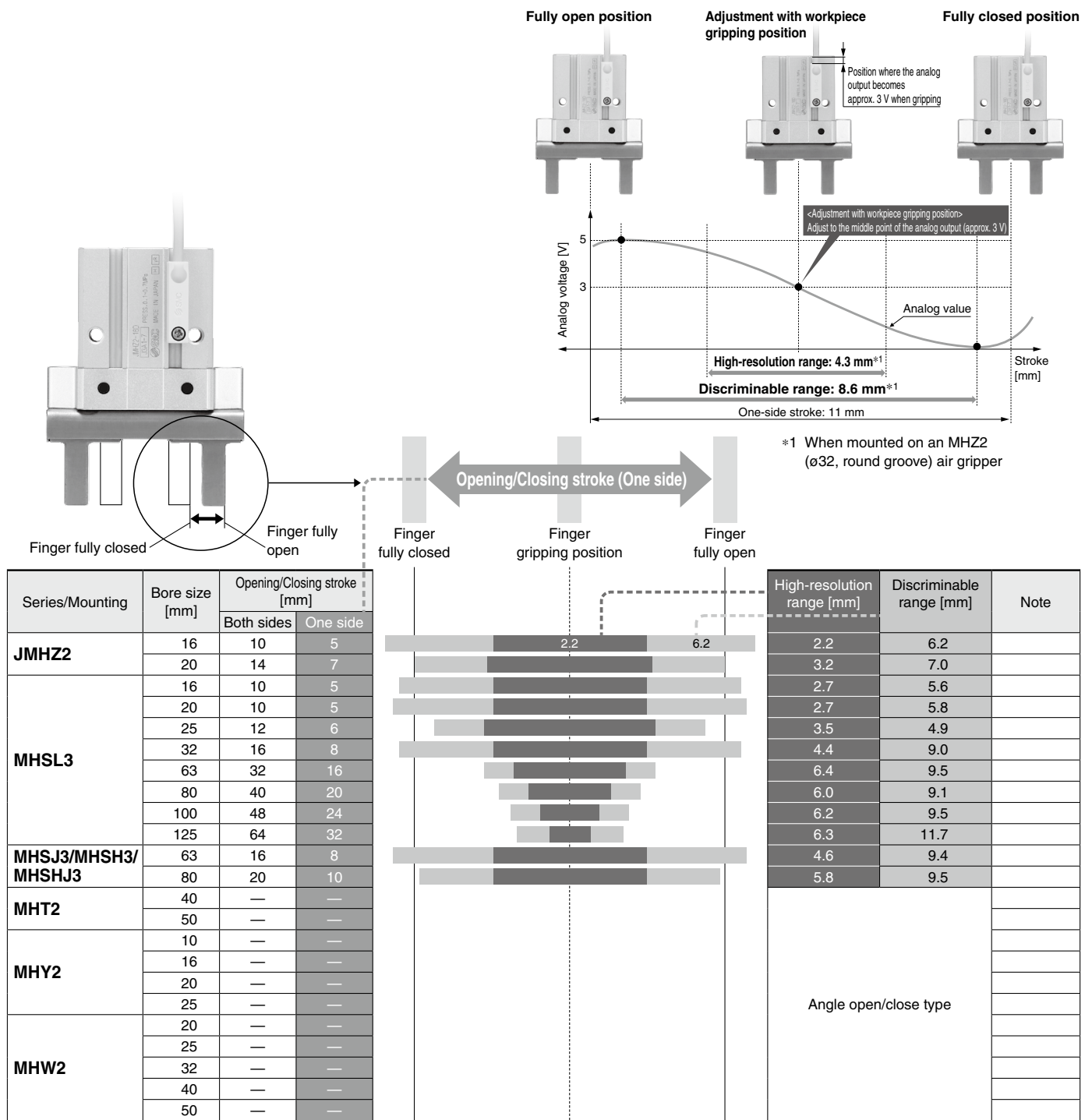

Relationship between the stroke, the switch mounting position, and the analog output

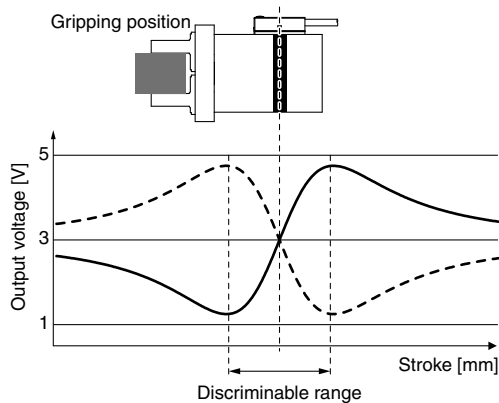

* Refer to page 10 for details on the mounting method.



D-MH1□ Series

Analog Auto Switch/Specific Product Precautions

Be sure to read this before handling the products. Refer to the back cover for safety instructions. For actuator and auto switch precautions, refer to the “Handling Precautions for SMC Products” and the “Operation Manual” on the SMC website.

Design / Selection

Caution

1. The product cannot be used for length measurement.

An analog auto switch outputs a magnetic field from the cylinder magnet as an analog value, and therefore the output is not linear to the cylinder stroke.

In addition, there are individual differences in the magnetic force of magnets. As such, the output values from magnets are different even if they are mounted to the same position on the same type actuator.

2. The resolution and repeatability vary depending on the position relationship between the magnet and the sensor.

The resolution and repeatability decrease near the maximum or minimum peak of analog output. Use them by mounting them to the recommended positions. If precision in repeatability is required, configure settings so that the analog output at the output position will be close to 3 V (in between peaks).

3. Analog output fluctuates due to the following factors.

Analog output fluctuates in an environment which is affected by the ambient temperature, mounting orientation (terrestrial magnetism), wobbling (mechanical factor, supply pressure fluctuation, etc.), electrical noise disturbance, magnetic body (iron screw, iron powder, etc.), or a magnetic force. It is recommended to use non-magnetic materials for magnetic bodies, bolts, and so on in the surroundings.

When using the product for an application where the ambient temperature or mounting orientation changes greatly, it is recommended to set the ON point under conditions that are close to the actual operating environment and set a wider ON width or hysteresis.

4. Take precautions when multiple cylinders or actuators are used close together.

When using two or more cylinders or actuators with a built-in magnet in close proximity to each other arranged in parallel, design so that they will maintain a separation distance of at least 40 mm.

(If the separation distance is specified for each of cylinder/actuator series, use that value.)

The accuracy of the analog auto switch may be reduced and it may malfunction due to the magnetic field interference between them.

Mounting / Adjustment

Caution

1. Adjust the mounting position of the analog auto switch after checking the actual operating conditions.

The full stroke may not be detected even for cylinders and actuators that can detect full strokes depending on the setting environment (magnetic bodies in the surroundings, temperature, etc.). In addition, the repeatability may deteriorate.

Confirm the operating conditions in the actual environment before use.

Maintenance

Warning

1. The analog auto switch may malfunction unexpectedly, making it impossible to confirm safety. Therefore, perform maintenance or inspection regularly.

Safety Instructions

These safety instructions are intended to prevent hazardous situations and/or equipment damage. These instructions indicate the level of potential hazard with the labels of “**Caution**,” “**Warning**” or “**Danger**.” They are all important notes for safety and must be followed in addition to International Standards (ISO/IEC)*1), and other safety regulations.

 **Danger :** **Danger** indicates a hazard with a high level of risk which, if not avoided, will result in death or serious injury.

 **Warning:** **Warning** indicates a hazard with a medium level of risk which, if not avoided, could result in death or serious injury.

 **Caution:** **Caution** indicates a hazard with a low level of risk which, if not avoided, could result in minor or moderate injury.

*1) ISO 4414: Pneumatic fluid power - General rules and safety requirements for systems and their components
ISO 4413: Hydraulic fluid power - General rules and safety requirements for systems and their components
IEC 60204-1: Safety of machinery - Electrical equipment of machines - Part 1: General requirements
ISO 10218-1: Robots and robotic devices - Safety requirements for industrial robots - Part 1: Robots etc.

Warning

1. The compatibility of the product is the responsibility of the person who designs the equipment or decides its specifications.

Since the product specified here is used under various operating conditions, its compatibility with specific equipment must be decided by the person who designs the equipment or decides its specifications based on necessary analysis and test results. The expected performance and safety assurance of the equipment will be the responsibility of the person who has determined its compatibility with the product. This person should also continuously review all specifications of the product referring to its latest catalog information, with a view to giving due consideration to any possibility of equipment failure when configuring the equipment.

2. Only personnel with appropriate training should operate machinery and equipment.

The product specified here may become unsafe if handled incorrectly. The assembly, operation and maintenance of machines or equipment including our products must be performed by an operator who is appropriately trained and experienced.

3. Do not service or attempt to remove product and machinery/equipment until safety is confirmed.

1. The inspection and maintenance of machinery/equipment should only be performed after measures to prevent falling or runaway of the driven objects have been confirmed.
2. When the product is to be removed, confirm that the safety measures as mentioned above are implemented and the power from any appropriate source is cut, and read and understand the specific product precautions of all relevant products carefully.
3. Before machinery/equipment is restarted, take measures to prevent unexpected operation and malfunction.

4. Our products cannot be used beyond their specifications. Our products are not developed, designed, and manufactured to be used under the following conditions or environments. Use under such conditions or environments is not covered.

1. Conditions and environments outside of the given specifications, or use outdoors or in a place exposed to direct sunlight.
2. Use for nuclear power, railways, aviation, space equipment, ships, vehicles, military application, equipment affecting human life, body, and property, fuel equipment, entertainment equipment, emergency shut-off circuits, press clutches, brake circuits, safety equipment, etc., and use for applications that do not conform to standard specifications such as catalogs and operation manuals.
3. Use for interlock circuits, except for use with double interlock such as installing a mechanical protection function in case of failure. Please periodically inspect the product to confirm that the product is operating properly.

Caution

We develop, design, and manufacture our products to be used for automatic control equipment, and provide them for peaceful use in manufacturing industries.

Use in non-manufacturing industries is not covered.

Products we manufacture and sell cannot be used for the purpose of transactions or certification specified in the Measurement Act.

The new Measurement Act prohibits use of any unit other than SI units in Japan.

Limited warranty and Disclaimer/ Compliance Requirements

The product used is subject to the following “Limited warranty and Disclaimer” and “Compliance Requirements”.

Read and accept them before using the product.

Limited warranty and Disclaimer

1. The warranty period of the product is 1 year in service or 1.5 years after the product is delivered, whichever is first.*2)
Also, the product may have specified durability, running distance or replacement parts. Please consult your nearest sales branch.
2. For any failure or damage reported within the warranty period which is clearly our responsibility, a replacement product or necessary parts will be provided.
This limited warranty applies only to our product independently, and not to any other damage incurred due to the failure of the product.
3. Prior to using SMC products, please read and understand the warranty terms and disclaimers noted in the specified catalog for the particular products.

*2) **Vacuum pads are excluded from this 1 year warranty.**

A vacuum pad is a consumable part, so it is warranted for a year after it is delivered.

Also, even within the warranty period, the wear of a product due to the use of the vacuum pad or failure due to the deterioration of rubber material are not covered by the limited warranty.

Compliance Requirements

1. The use of SMC products with production equipment for the manufacture of weapons of mass destruction (WMD) or any other weapon is strictly prohibited.
2. The exports of SMC products or technology from one country to another are governed by the relevant security laws and regulations of the countries involved in the transaction. Prior to the shipment of a SMC product to another country, assure that all local rules governing that export are known and followed.

Safety Instructions

Be sure to read the “Handling Precautions for SMC Products” (M-E03-3) and “Operation Manual” before use.

SMC Corporation