

Push-lock Type

New
RoHS

Dual Speed Controller with One-touch Fitting

Allows for simultaneous meter-in and meter-out control

Prevents cylinders from popping out, and allows for the speed control of single acting cylinders

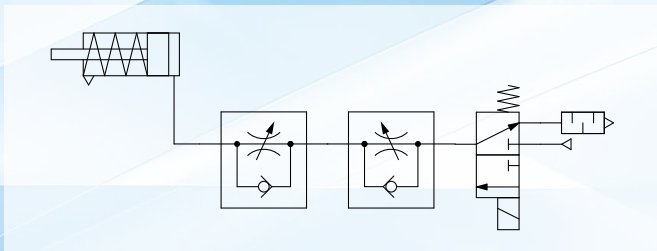

Easy identification of meter-in or meter-out by knob color

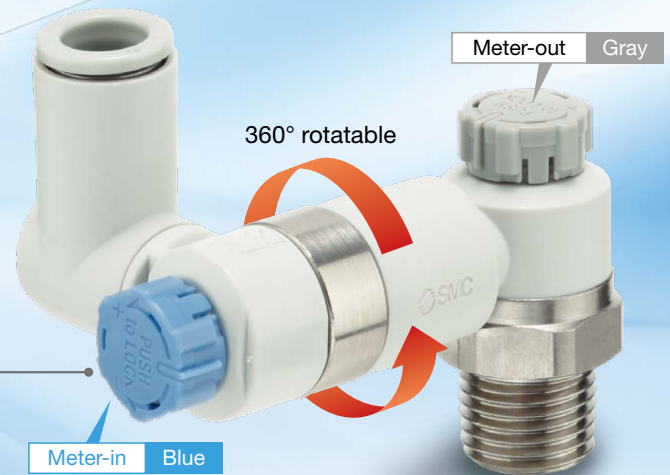

Push-lock Type

- No tools required.
- Large one-push lock type knob
- Improved workability

Lightweight

Weight: Approx. **28% lighter**



Flow Rate Reproducibility



Improved reproducibility of flow rate

Stable knob position when fully closed (no flow rate) onto the contact face stopper (rotating stopper). Minimal flow rate variations between knob rotations

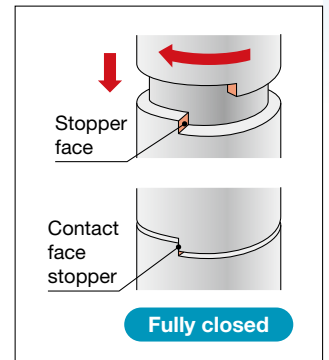

Variations

One-touch fitting type	Port size	Applicable tubing O.D.		
		Metric size	Inch size	
	M5 x 0.8	4, 6	—	
	10-32UNF	—	1/8", 5/32", 1/4"	
	R G NPT	1/8	6, 8	1/4", 5/16"
		1/4	6, 8, 10, 12	1/4", 5/16", 3/8"
		3/8	6, 8, 10, 12	1/4", 5/16", 3/8"
	1/2	10, 12	3/8"	

ASD-A Series

SMC
CAT.ES20-305A

Push-lock Type

Dual Speed Controller with One-touch Fitting

ASD-A Series

RoHS

Model

Model	Port size		Seal method	Applicable tubing O.D.																	
				Metric size					Inch size												
				ø4	ø6	ø8	ø10	ø12	ø1/8"	ø5/32"	ø1/4"	ø5/16"	ø3/8"								
ASD230F-M5	M5 x 0.8		Gasket seal	●	●																
ASD330F-□01	R G	1/8	Sealant (R)*1 Face seal (G)		●	●															
ASD430F-□02		1/4			●	●	●														
ASD530F-□02		1/4			●	●	●	●													
ASD530F-□03		3/8			●	●	●	●	●												
ASD630F-□04		1/2					●	●													
ASD230F-U10/32	10-32UNF		Gasket seal							●	●	●									
ASD330F-□01	NPT	1/8	Sealant*1									●	●								
ASD430F-□02		1/4											●	●	●						
ASD530F-□02		1/4											●	●	●	●					
ASD530F-□03		3/8											●	●	●	●					
ASD630F-□04		1/2												●	●	●	●				

*1 "Without sealant" type can be selected as a standard option.

Enables bi-directional flow control.
Unrestricted 360° tube mounting direction.

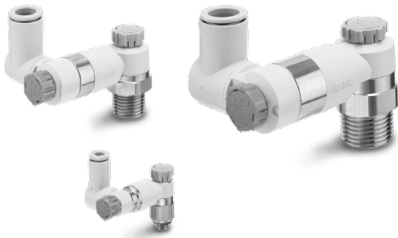

Specifications

Fluid	Air
Proof pressure	1.5 MPa
Max. operating pressure	1.0 MPa
Min. operating pressure	0.1 MPa
Ambient and fluid temperatures	-5 to 60°C (No freezing)
Applicable tubing material	Nylon, Soft nylon, Polyurethane*1, FEP, PFA

*1 Use caution at the max. operating pressure when using soft nylon or polyurethane tubing.
(Refer to the [Web Catalog](#) for details.)

Symbol

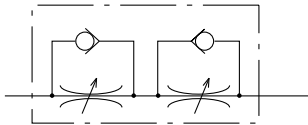

Flow Direction Symbols on Body

	Meter-out	Meter-in
Symbol		

Flow Rate and Sonic Conductance

Model		ASD230F	ASD330F	ASD430F	ASD530F			ASD630F		
Tubing O.D.	Metric size	ø4, ø6	ø6, ø8	ø6, ø10	ø6, ø8, ø10, ø12	ø6, ø8	ø10, ø12	ø10	ø12	
	Inch size	ø1/8", ø5/32", ø1/4"	ø1/4", ø5/16"	—	ø1/4", ø5/16", ø3/8"	ø1/4", ø5/16"	ø3/8"	ø3/8"	—	
C values: Sonic conductance dm ³ /(s·bar)	Free flow	0.24	0.58	0.98	1.06	1.44	1.58	2.04	2.71	3.07
	Controlled flow	0.24	0.58	0.98	1.06	1.44	1.58	2.04	2.71	3.07
b values: Critical pressure ratio	Free flow	0.35	0.25	0.35	0.25			0.30		
	Controlled flow	0.15	0.25	0.25	0.35			0.30		

⚠ Caution

Be sure to read this before handling the products. Refer to the back cover for safety instructions. For flow control equipment precautions, refer to the "Handling Precautions for SMC Products" and the "Operation Manual" on the SMC website.

Made to Order



Lubricant: Vaseline **X12**

Example) ASD330F-01-06A-X12

How to Order

ASD 3 30 F - 01 - 06 S A -

Body size

2	M5 x 0.8 10-32UNF
3	1/8
4	1/4
5	3/8
6	1/2

• **Made to Order**
Refer to page 1 for details.

• **Push-lock type**

• **Seal method**

Nil	Without sealant
S	With sealant

* Select Nil (Without sealant) for M5, U10/32, and G thread.

• **Applicable tubing O.D.*1**

Metric size		Inch size	
04	ø4	01	ø1/8"
06	ø6	03	ø5/32"
08	ø8	07	ø1/4"
10	ø10	09	ø5/16"
12	ø12	11	ø3/8"

*1 For applicable tubing O.D. selection, refer to the Model on page 1.

• **With One-touch fitting**

• **Thread type**

Nil	R
N	NPT
G	G

• **Bore size**

M5	M5 x 0.8
U10/32	10-32UNF
01	1/8
02	1/4
03	3/8
04	1/2

Needle Valve/Flow Rate Characteristics: Inlet Pressure: 0.5 MPa

* The flow rate characteristics are representative values.

ASD230F

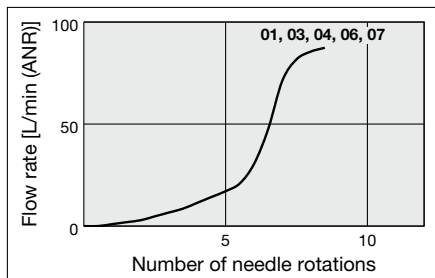

ASD330F

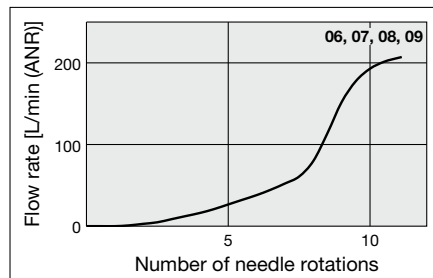

ASD430F

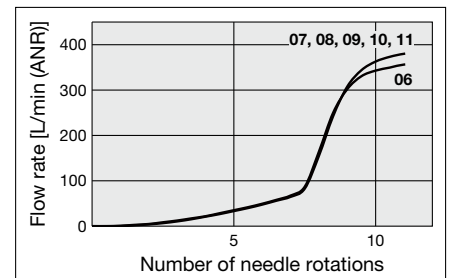

ASD530F

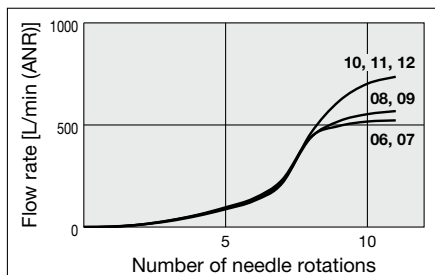

ASD630F

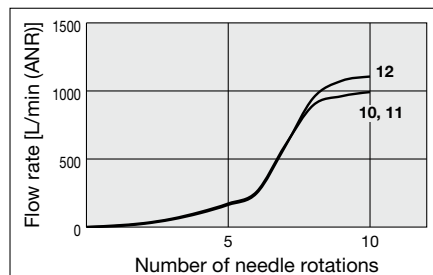

ASD-A Series

Dimensions

Seal method: Gasket seal
For M5, 10-32UNF

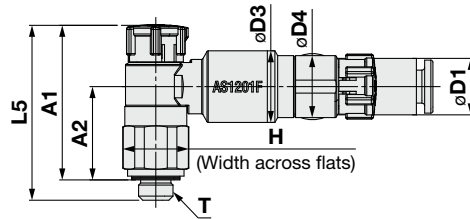
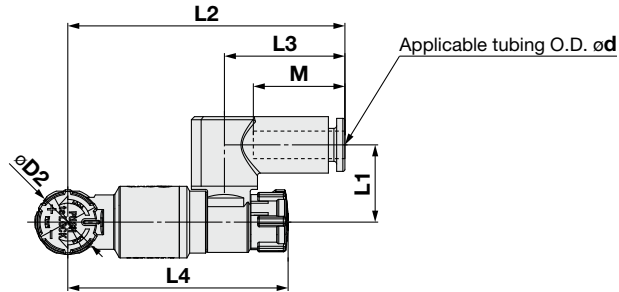

Metric Size

Model	d	T	H	D1	D2	D3	D4	L1	L2	L3	L4		L5		A1		A2	M1	Weight [g]
											Unlocked	Locked	Unlocked	Locked	Unlocked	Locked			
ASD230F-M5-04A	4	M5 x 0.8	9	8.2	9.4	10.4	9.0	11.5	40.3	17.5	33.1	32.0	26.5	25.4	23.5	22.4	13.5	13.3	11
ASD230F-M5-06A	6	M5 x 0.8	9	10.4	9.4	10.4	9.0	11.5	43.2	20.4	33.1	32.0	26.5	25.4	23.5	22.4	13.5	13.3	11

Inch Size

Model	d	T	H	D1	D2	D3	D4	L1	L2	L3	L4		L5		A1		A2	M1	Weight [g]
											Unlocked	Locked	Unlocked	Locked	Unlocked	Locked			
ASD230F-U10/32-01A	1/8"	10/32UNF	9	7.2	9.4	10.4	9.0	11.6	40.3	17.5	33.1	32.0	26.5	25.4	23.5	22.4	13.5	13.3	11
ASD230F-U10/32-03A	5/32"	10/32UNF	9	8.2	9.4	10.4	9.0	11.5	40.3	17.5	33.1	32.0	26.5	25.4	23.5	22.4	13.5	13.3	11
ASD230F-U10/32-07A	1/4"	10/32UNF	9	11.2	9.4	10.4	9.0	11.5	43.0	20.2	33.1	32.0	26.5	25.4	23.5	22.4	13.5	13.3	11

Dimensions

Seal method: Sealant
For R, NPT thread

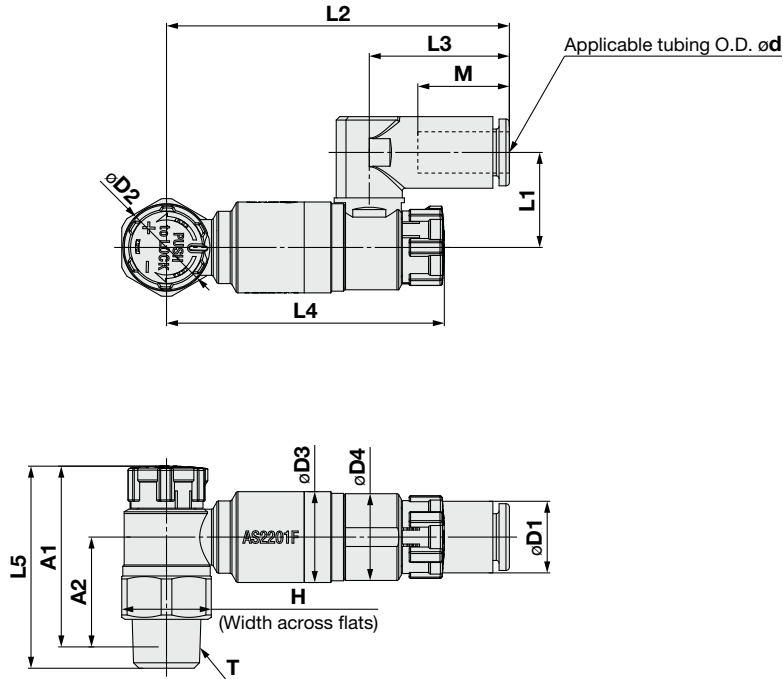

Metric Size

Model	d	T	H	D1	D2	D3	D4	L1	L2	L3	L4		L5		A1		A2	M1	Weight [g]
											Unlocked	Locked	Unlocked	Locked	Unlocked	Locked			
ASD330F-01-06(S)A	6	1/8	13	10.4	12.0	13.2	12.6	13.9	50.5	20.4	41.8	40.4	30.6	29.2	27.5	26.1	16.0	13.3	21
ASD330F-01-08(S)A	8	1/8	13	13.2	12.0	13.2	12.6	16.4	51.6	21.5	41.8	40.4	30.6	29.2	27.5	26.1	16.0	14.2	22
ASD430F-02-06(S)A	6	1/4	17	11.2	13.0	16.7	16.6	19.0	57.3	21.4	50.1	48.5	36.6	35.0	31.1	29.5	17.1	13.3	36
ASD430F-02-08(S)A	8	1/4	17	13.2	13.0	16.7	16.6	19.0	59.4	23.5	50.1	48.5	36.6	35.0	31.1	29.5	17.1	14.2	37
ASD430F-02-10(S)A	10	1/4	17	15.9	13.0	16.7	16.6	20.9	60.6	24.7	50.1	48.5	36.6	35.0	31.1	29.5	17.1	15.6	38
ASD530F-02-06(S)A	6	1/4	19	11.2	16.6	19.0	19.0	20.2	63.2	21.4	55.5	53.9	50.0	48.4	44.5	42.9	29.0	13.3	65
ASD530F-02-08(S)A	8	1/4	19	13.2	16.6	19.0	19.0	20.2	65.3	23.5	55.5	53.9	50.0	48.4	44.5	42.9	29.0	14.2	66
ASD530F-02-10(S)A	10	1/4	19	15.9	16.6	19.0	19.0	23.0	67.9	26.1	55.5	53.9	50.0	48.4	44.5	42.9	29.0	15.6	69
ASD530F-02-12(S)A	12	1/4	19	18.5	16.6	19.0	19.0	23.0	70.1	28.3	55.5	53.9	50.0	48.4	44.5	42.9	29.0	17.0	71
ASD530F-03-06(S)A	6	3/8	19	11.2	16.6	19.0	19.0	20.2	63.2	21.4	55.5	53.9	42.3	40.7	37.1	35.5	21.6	13.3	56
ASD530F-03-08(S)A	8	3/8	19	13.2	16.6	19.0	19.0	20.2	65.3	23.5	55.5	53.9	42.3	40.7	37.1	35.5	21.6	14.2	57
ASD530F-03-10(S)A	10	3/8	19	15.9	16.6	19.0	19.0	23.0	67.9	26.1	55.5	53.9	42.3	40.7	37.1	35.5	21.6	15.6	60
ASD530F-03-12(S)A	12	3/8	19	18.5	16.6	19.0	19.0	23.0	70.1	28.3	55.5	53.9	42.3	40.7	37.1	35.5	21.6	17.0	62
ASD630F-04-10(S)A	10	1/2	24	15.9	18.8	24.0	24.0	25.6	77.2	26.1	66.8	65.2	50.8	49.2	43.7	42.1	25.6	15.6	104
ASD630F-04-12(S)A	12	1/2	24	18.5	18.8	24.0	24.0	26.2	79.4	28.3	66.8	65.2	50.8	49.2	43.7	42.1	25.6	17.0	107

Inch Size

Model	d	T	H	D1	D2	D3	D4	L1	L2	L3	L4		L5		A1		A2	M1	Weight [g]
											Unlocked	Locked	Unlocked	Locked	Unlocked	Locked			
ASD330F-N01-07(S)A	1/4"	1/8	12.7	11.2	12.0	13.2	12.6	16.4	50.3	20.2	41.8	40.4	30.6	29.2	27.5	26.1	16.0	13.3	20
ASD330F-N01-09(S)A	5/16"	1/8	12.7	13.2	12.0	13.2	12.6	16.4	51.6	21.5	41.8	40.4	30.6	29.2	27.5	26.1	16.0	14.2	21
ASD430F-N02-07(S)A	1/4"	1/4	17.5	11.2	13.0	16.7	16.6	19.0	57.3	21.4	50.1	48.5	36.6	35.0	31.1	29.5	17.1	13.3	37
ASD430F-N02-09(S)A	5/16"	1/4	17.5	13.2	13.0	16.7	16.6	19.0	59.4	23.5	50.1	48.5	36.6	35.0	31.1	29.5	17.1	14.2	38
ASD430F-N02-11(S)A	3/8"	1/4	17.5	15.9	13.0	16.7	16.6	20.9	60.6	24.7	50.1	48.5	36.6	35.0	31.1	29.5	17.1	15.6	39
ASD530F-N02-07(S)A	1/4"	1/4	19	11.2	16.6	19.0	19.0	20.2	63.2	21.4	55.5	53.9	50.0	48.4	44.5	42.9	29.0	13.3	65
ASD530F-N02-09(S)A	5/16"	1/4	19	13.2	16.6	19.0	19.0	20.2	65.3	23.5	55.5	53.9	50.0	48.4	44.5	42.9	29.0	14.2	66
ASD530F-N02-11(S)A	3/8"	1/4	19	15.9	16.6	19.0	19.0	23.0	67.9	26.1	55.5	53.9	50.0	48.4	44.5	42.9	29.0	15.6	69
ASD530F-N03-07(S)A	1/4"	3/8	19	11.2	16.6	19.0	19.0	20.2	63.2	21.4	55.5	53.9	42.3	40.7	37.1	35.5	21.6	13.3	57
ASD530F-N03-09(S)A	5/16"	3/8	19	13.2	16.6	19.0	19.0	20.2	65.3	23.5	55.5	53.9	42.3	40.7	37.1	35.5	21.6	14.2	58
ASD530F-N03-11(S)A	3/8"	3/8	19	15.9	16.6	19.0	19.0	23.0	67.9	26.1	55.5	53.9	42.3	40.7	37.1	35.5	21.6	15.6	61
ASD630F-N04-11(S)A	3/8"	1/2	23.8	15.9	18.8	24.0	24.0	25.6	77.2	26.1	66.8	65.2	50.8	49.2	43.7	42.1	25.6	15.6	103

ASD-A Series

Dimensions

Seal method: Face seal
For G thread

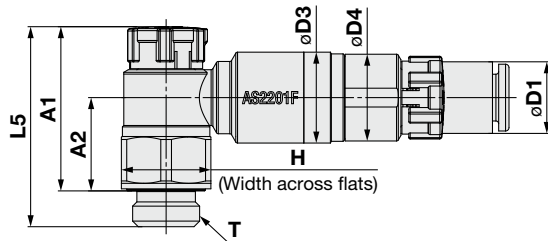
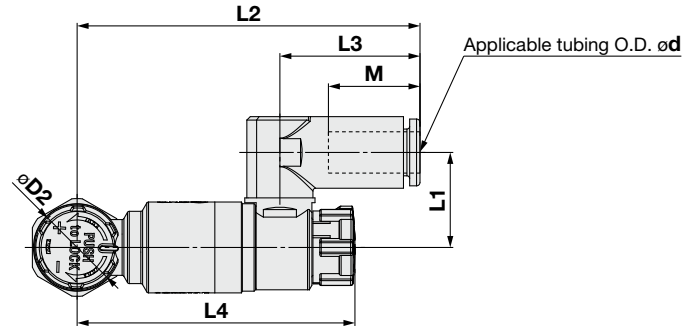

Metric Size

Model	d	T	H	D1	D2	D3	D4	L1	L2	L3	L4		L5		A1		A2	M1	Weight [g]
											Unlocked	Locked	Unlocked	Locked	Unlocked	Locked			
ASD330F-G01-06A	6	1/8	13	10.4	12.0	13.2	12.6	13.9	50.5	20.4	41.8	40.4	30.3	28.9	24.8	23.4	13.3	13.3	21
ASD330F-G01-08A	8	1/8	13	13.2	12.0	13.2	12.6	16.4	51.6	21.5	41.8	40.4	30.3	28.9	24.8	23.4	13.3	14.2	22
ASD430F-G02-06A	6	1/4	17	11.2	13.0	16.7	16.6	19.0	57.3	21.4	50.1	48.5	36.6	35.0	30.1	28.5	16.1	13.3	39
ASD430F-G02-08A	8	1/4	17	13.2	13.0	16.7	16.6	19.0	59.4	23.5	50.1	48.5	36.6	35.0	30.1	28.5	16.1	14.2	40
ASD430F-G02-10A	10	1/4	17	15.9	13.0	16.7	16.6	20.9	60.6	24.7	50.1	48.5	36.6	35.0	30.1	28.5	16.1	15.6	41
ASD530F-G02-06A	6	1/4	21	11.2	16.6	19.0	19.0	20.2	63.2	21.4	55.5	53.9	50.0	48.4	43.5	41.9	28.0	13.3	75
ASD530F-G02-08A	8	1/4	21	13.2	16.6	19.0	19.0	20.2	65.3	23.5	55.5	53.9	50.0	48.4	43.5	41.9	28.0	14.2	76
ASD530F-G02-10A	10	1/4	21	15.9	16.6	19.0	19.0	23.0	67.9	26.1	55.5	53.9	50.0	48.4	43.5	41.9	28.0	15.6	79
ASD530F-G02-12A	12	1/4	21	18.5	16.6	19.0	19.0	23.0	70.1	28.3	55.5	53.9	50.0	48.4	43.5	41.9	28.0	17.0	81
ASD530F-G03-06A	6	3/8	21	11.2	16.6	19.0	19.0	20.2	63.2	21.4	55.5	53.9	42.3	40.7	34.8	33.2	19.3	13.3	64
ASD530F-G03-08A	8	3/8	21	13.2	16.6	19.0	19.0	20.2	65.3	23.5	55.5	53.9	42.3	40.7	34.8	33.2	19.3	14.2	65
ASD530F-G03-10A	10	3/8	21	15.9	16.6	19.0	19.0	23.0	67.9	26.1	55.5	53.9	42.3	40.7	34.8	33.2	19.3	15.6	68
ASD530F-G03-12A	12	3/8	21	18.5	16.6	19.0	19.0	23.0	70.1	28.3	55.5	53.9	42.3	40.7	34.8	33.2	19.3	17.0	70
ASD630F-G04-10A	10	1/2	27	15.9	18.8	24.0	24.0	25.6	77.2	26.1	66.8	65.2	50.8	49.2	41.8	40.2	23.7	15.6	122
ASD630F-G04-12A	12	1/2	27	18.5	18.8	24.0	24.0	26.2	79.4	28.3	66.8	65.2	50.8	49.2	41.8	40.2	23.7	17.0	125



ASD-A Series Specific Product Precautions

Be sure to read this before handling the products. Refer to the back cover for safety instructions. For flow control equipment precautions, refer to the “Handling Precautions for SMC Products” and the “Operation Manual” on the SMC website.

Design/Selection

Warning

1. Confirm the specifications.

Products represented in this catalog are designed only for use in compressed air systems (including vacuum). Do not operate at pressures, temperatures, etc., beyond the range of specifications, as this can cause damage or malfunction. (Refer to the specifications.)

Please contact SMC when using a fluid other than compressed air (including vacuum). We do not guarantee against any damage if the product is used outside of the specification range.

2. Products mentioned in this catalog are not designed for use as stop valves with zero air leakage.

A certain amount of leakage is allowed in the products' specifications. Tightening the needle to reduce leakage to zero may result in equipment damage.

3. Do not disassemble the product or make any modifications, including additional machining.

Doing so may cause human injury and/or an accident.

4. The flow rate characteristics for each product are representative values.

The flow rate characteristics are characteristics of each individual product. Actual values may differ depending on the piping, circuitry, pressure conditions, etc.

5. Sonic conductance (C) and critical pressure ratio (b) values for products are representative values. In addition, the speed controller controlled flow and free flow values are the values when the needle is fully open.

6. Check if PTFE can be used in the application.

PTFE powder (Polytetrafluoroethylene resin) is included in the seal material of the male thread type piping taper thread. Confirm that the use of it will not cause any adverse effects on the system. Please contact SMC if the Safety Data Sheet (SDS) is required.

7. Speed controllers are designed to control the speed of the actuator.

Mounting

Warning

1. Operation manual

Install the product and operate it only after reading the operation manual carefully and understanding its contents. Also, keep the manual where it can be referred to as necessary.

2. Ensure sufficient space for maintenance activities.

When installing the products, allow access for maintenance and inspection.

3. Tighten threads with the proper tightening torque.

When installing the products, follow the listed torque specifications.

4. After pushing the knob down to lock, confirm that it is locked.

It should not be possible to rotate the knob to the right or to the left. If the knob is pulled with force, it may break. Do not pull the knob with excessive force.

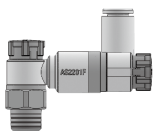

Locked



Unlocked

Mounting

Warning

5. Check the degree of rotation of the needle valve.

Products mentioned in this catalog are retainer types, so the needle is not removed completely. Over rotation will cause damage.

6. Do not use tools, such as pliers, to rotate the knob.

This can cause the idle rotation of the knob or damage.

7. Adjust the needle by opening the needle slowly after having closed it completely.

Loose needle valves may cause unexpected sudden actuator extension. When a needle valve is turned clockwise, it is closed and cylinder speed decreases. When a needle valve is turned counterclockwise, it is open and cylinder speed increases.

8. Do not apply excessive force or shock to the body or fittings with an impact tool.

This can cause damage or air leakage.

9. Refer to the Fittings and Tubing Precautions on the SMC website for handling One-touch fittings.

10. To install/remove flow control equipment, use an appropriate wrench to tighten/loosen the supplied nut on body B as close to the thread as possible.

Do not apply torque at other points, as the product may be damaged. Rotate body A manually for positioning after installation.

11. When performing the piping work, turn the tightening tool in the horizontal direction to the hexagon across flats of body B so that any moment is not applied to the body A.

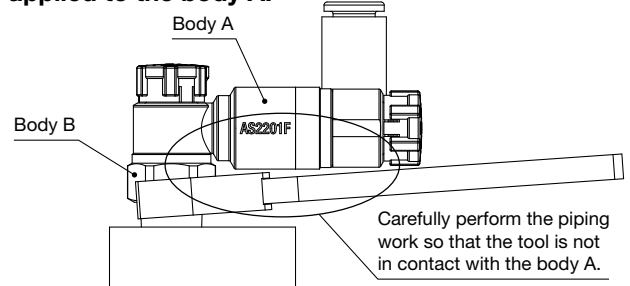

12. Do not use tools on the product when pressurized.

13. Do not use body A and/or elbow body for applications involving continuous rotation.

Body A and the fitting section may be damaged.

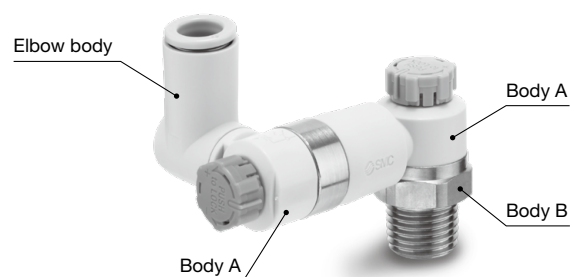

Safety Instructions

These safety instructions are intended to prevent hazardous situations and/or equipment damage. These instructions indicate the level of potential hazard with the labels of “**Caution**,” “**Warning**” or “**Danger**.” They are all important notes for safety and must be followed in addition to International Standards (ISO/IEC)*1), and other safety regulations.

 **Danger :** **Danger** indicates a hazard with a high level of risk which, if not avoided, will result in death or serious injury.

 **Warning:** **Warning** indicates a hazard with a medium level of risk which, if not avoided, could result in death or serious injury.

 **Caution:** **Caution** indicates a hazard with a low level of risk which, if not avoided, could result in minor or moderate injury.

*1) ISO 4414: Pneumatic fluid power - General rules and safety requirements for systems and their components
ISO 4413: Hydraulic fluid power - General rules and safety requirements for systems and their components
IEC 60204-1: Safety of machinery - Electrical equipment of machines - Part 1: General requirements
ISO 10218-1: Robots and robotic devices - Safety requirements for industrial robots - Part 1: Robots etc.

Warning

1. The compatibility of the product is the responsibility of the person who designs the equipment or decides its specifications.

Since the product specified here is used under various operating conditions, its compatibility with specific equipment must be decided by the person who designs the equipment or decides its specifications based on necessary analysis and test results. The expected performance and safety assurance of the equipment will be the responsibility of the person who has determined its compatibility with the product. This person should also continuously review all specifications of the product referring to its latest catalog information, with a view to giving due consideration to any possibility of equipment failure when configuring the equipment.

2. Only personnel with appropriate training should operate machinery and equipment.

The product specified here may become unsafe if handled incorrectly. The assembly, operation and maintenance of machines or equipment including our products must be performed by an operator who is appropriately trained and experienced.

3. Do not service or attempt to remove product and machinery/equipment until safety is confirmed.

1. The inspection and maintenance of machinery/equipment should only be performed after measures to prevent falling or runaway of the driven objects have been confirmed.
2. When the product is to be removed, confirm that the safety measures as mentioned above are implemented and the power from any appropriate source is cut, and read and understand the specific product precautions of all relevant products carefully.
3. Before machinery/equipment is restarted, take measures to prevent unexpected operation and malfunction.

4. Our products cannot be used beyond their specifications. Our products are not developed, designed, and manufactured to be used under the following conditions or environments. Use under such conditions or environments is not covered.

1. Conditions and environments outside of the given specifications, or use outdoors or in a place exposed to direct sunlight.
2. Use for nuclear power, railways, aviation, space equipment, ships, vehicles, military application, equipment affecting human life, body, and property, fuel equipment, entertainment equipment, emergency shut-off circuits, press clutches, brake circuits, safety equipment, etc., and use for applications that do not conform to standard specifications such as catalogs and operation manuals.
3. Use for interlock circuits, except for use with double interlock such as installing a mechanical protection function in case of failure. Please periodically inspect the product to confirm that the product is operating properly.

Caution

We develop, design, and manufacture our products to be used for automatic control equipment, and provide them for peaceful use in manufacturing industries.

Use in non-manufacturing industries is not covered.

Products we manufacture and sell cannot be used for the purpose of transactions or certification specified in the Measurement Act.

The new Measurement Act prohibits use of any unit other than SI units in Japan.

Limited warranty and Disclaimer/ Compliance Requirements

The product used is subject to the following “Limited warranty and Disclaimer” and “Compliance Requirements”.

Read and accept them before using the product.

Limited warranty and Disclaimer

1. The warranty period of the product is 1 year in service or 1.5 years after the product is delivered, whichever is first.*2)
Also, the product may have specified durability, running distance or replacement parts. Please consult your nearest sales branch.
2. For any failure or damage reported within the warranty period which is clearly our responsibility, a replacement product or necessary parts will be provided. This limited warranty applies only to our product independently, and not to any other damage incurred due to the failure of the product.
3. Prior to using SMC products, please read and understand the warranty terms and disclaimers noted in the specified catalog for the particular products.

*2) **Vacuum pads are excluded from this 1 year warranty.**

A vacuum pad is a consumable part, so it is warranted for a year after it is delivered.

Also, even within the warranty period, the wear of a product due to the use of the vacuum pad or failure due to the deterioration of rubber material are not covered by the limited warranty.

Compliance Requirements

1. The use of SMC products with production equipment for the manufacture of weapons of mass destruction (WMD) or any other weapon is strictly prohibited.
2. The exports of SMC products or technology from one country to another are governed by the relevant security laws and regulations of the countries involved in the transaction. Prior to the shipment of a SMC product to another country, assure that all local rules governing that export are known and followed.

Safety Instructions

Be sure to read the “Handling Precautions for SMC Products” (M-E03-3) and “Operation Manual” before use.

SMC Corporation