

Elastic Finger

New

RoHS

Rubber sheet fingers enable gripping of an indefinite workpiece

- Design of the finger according to the workpiece shape is not required.
- Allows for gripping of tightly packed workpieces



The elastic finger mounting attachment to be produced by the customer.

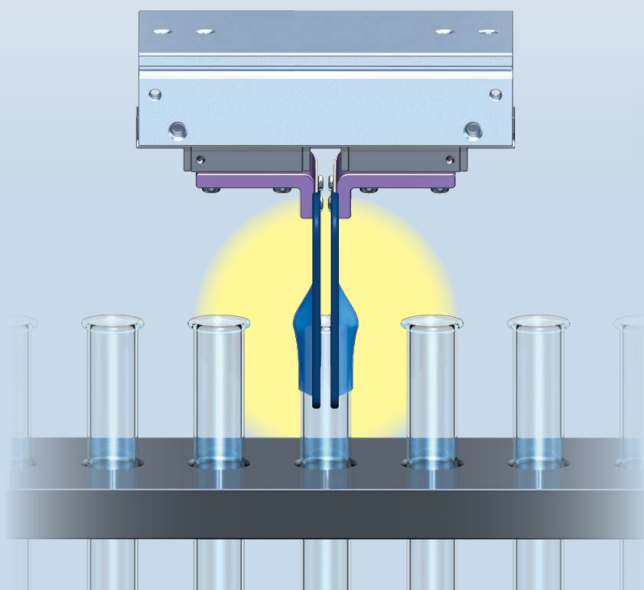

Material Silicone rubber (Blue)

This product is made of materials compliant with FDA (U.S. Food and Drug Administration) regulations as well as Japan Food Sanitation Act standards.

Material EPDM (Black)

Example Applications

Raw eggs

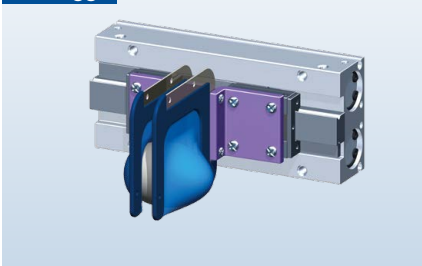

Plastic bottles

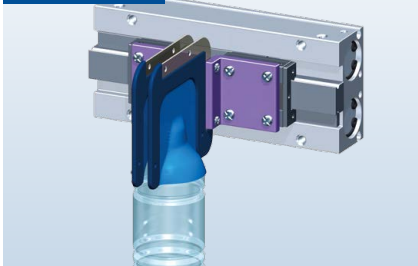

Beverage cans

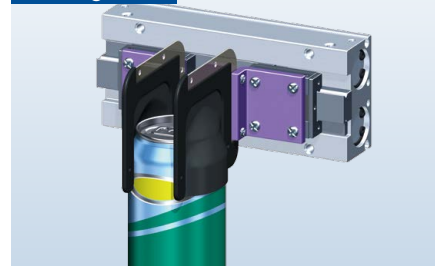

Bearings

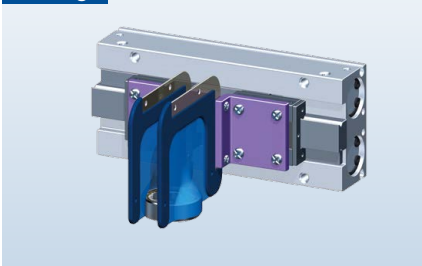

Electrical connectors

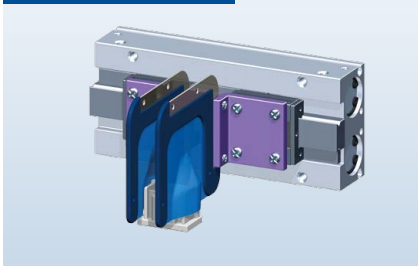

Metal parts

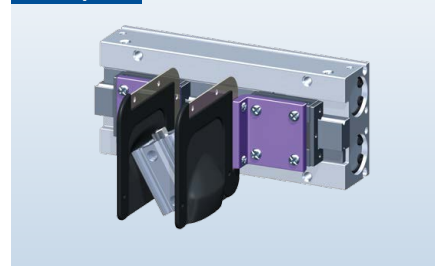

* Please use the product in accordance with the specifications provided in the catalogs/operation manuals. It is your responsibility to check the suitability for your workpiece and equipment.

MH-X7654



CAT.ES20-308A

Elastic Finger MH-X7654



How to Order

MH-AT1A090080 **E** -X7654

1 Material

E	EPDM (Black)
S	Silicone rubber (Blue)

* When using with a 2-finger gripper, please order 2 of this product, to ensure 1 per finger.

Specifications

Model	MH-AT1A090080E	MH-AT1A090080S
Rubber material	Ethylene propylene rubber (EPDM)	Silicone rubber (Si) ^{*1}
Color	Black	Blue
Metal (Mounting)	Stainless steel	
Effective gripping surface [mm]	58 x 60	
Weight^{*2} [g]	35.6	34.4

*1 Only the rubber parts are compliant with the FDA's (U.S. Food and Drug Administration) 21CFR § 177.2600 dissolution test. The adhesive between the rubber and the metal plates is not FDA-compliant.

*2 Weight per finger

Workpiece Characteristics & Max. Mass

● Max. workpiece mass

The graph shows the max. workpiece mass for a round bar, a square bar, and sphere. These values are for reference only, as they vary depending on the workpiece material, shape, etc.

When workpiece protrudes from the fingers



Diameter d x Length L [mm]	ø40 x 60
Surface roughness Rz [μm]	4.3

Width W x Depth D x Length L [mm]	40 x 40 x 60
Surface roughness Rz [μm]	1.2

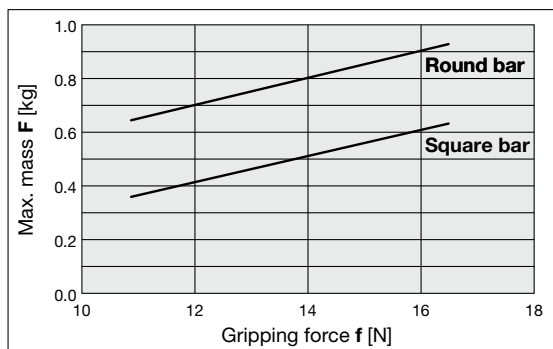
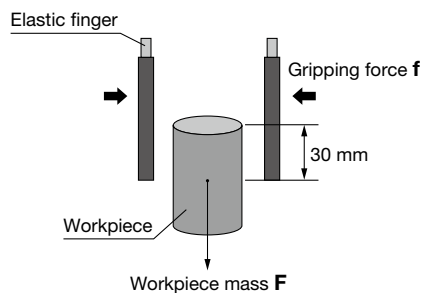

When workpiece does not protrude from the fingers

Sphere

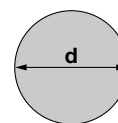

Diameter d [mm]	So40
Surface roughness Rz [μm]	0.8

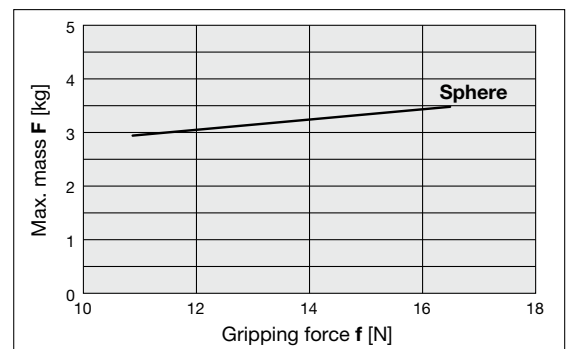
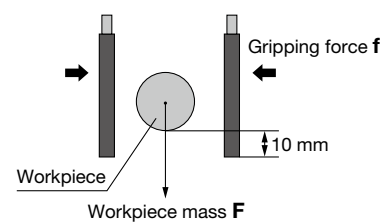

⚠ Caution

Please check with the actual workpiece before use.

The grippable and holdable mass varies depending on workpiece characteristics including material, shape, mass, and surface condition.

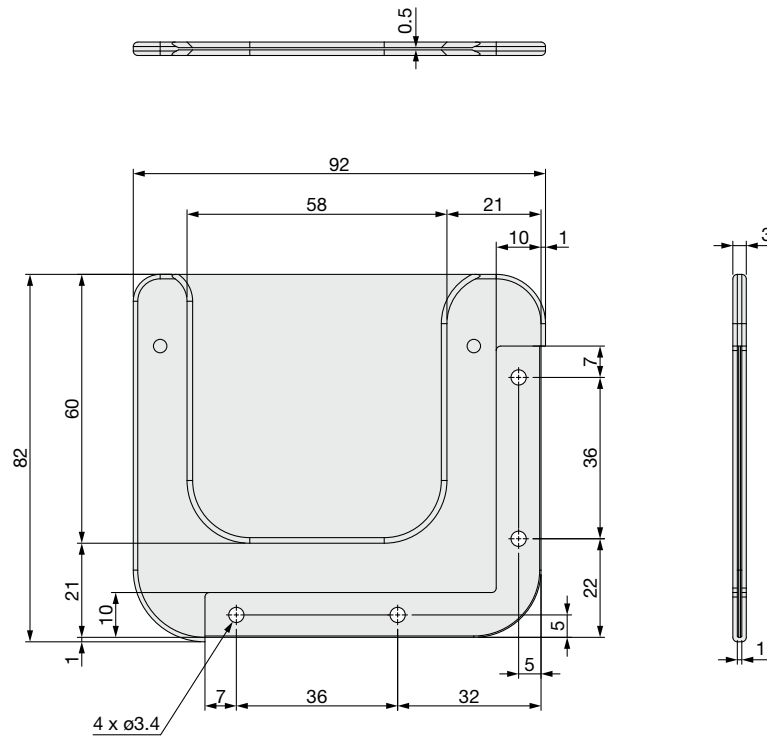
Dimensions**⚠ Specific Product Precautions**

Be sure to read this before handling the products. Refer to the back cover for safety instructions. For other details, refer to the "Handling Precautions for SMC Products" and the "Operation Manual" on the SMC website.

Design**⚠ Warning**

1. If workpiece is heavy or hazardous, take measures to prevent loss of gripping force (guide for drop prevention, etc.).

For the pneumatic transfer unit with the elastic finger, there is a danger of workpieces dropping if there is a decrease in gripping force due to a drop in circuit pressure caused by a power failure or trouble with the air supply.

In addition, it is necessary to take measures such as drop prevention, so that injury and damage to machinery or equipment can be prevented; and maintenance of the elastic finger, because the gripping force will decrease with abrasion or cracks.

2. Gripping sharp protruding parts of a workpiece may damage the rubber. Be sure to check compatibility with the actual workpiece before use.

Elastic Finger

Safety Instructions

These safety instructions are intended to prevent hazardous situations and/or equipment damage. These instructions indicate the level of potential hazard with the labels of “**Caution**,” “**Warning**” or “**Danger**.” They are all important notes for safety and must be followed in addition to International Standards (ISO/IEC)*1), and other safety regulations.

 **Danger :** **Danger** indicates a hazard with a high level of risk which, if not avoided, will result in death or serious injury.

 **Warning:** **Warning** indicates a hazard with a medium level of risk which, if not avoided, could result in death or serious injury.

 **Caution:** **Caution** indicates a hazard with a low level of risk which, if not avoided, could result in minor or moderate injury.

*1) ISO 4414: Pneumatic fluid power - General rules and safety requirements for systems and their components
ISO 4413: Hydraulic fluid power - General rules and safety requirements for systems and their components
IEC 60204-1: Safety of machinery - Electrical equipment of machines - Part 1: General requirements
ISO 10218-1: Robots and robotic devices - Safety requirements for industrial robots - Part 1: Robots etc.

Warning

1. The compatibility of the product is the responsibility of the person who designs the equipment or decides its specifications.

Since the product specified here is used under various operating conditions, its compatibility with specific equipment must be decided by the person who designs the equipment or decides its specifications based on necessary analysis and test results. The expected performance and safety assurance of the equipment will be the responsibility of the person who has determined its compatibility with the product. This person should also continuously review all specifications of the product referring to its latest catalog information, with a view to giving due consideration to any possibility of equipment failure when configuring the equipment.

2. Only personnel with appropriate training should operate machinery and equipment.

The product specified here may become unsafe if handled incorrectly. The assembly, operation and maintenance of machines or equipment including our products must be performed by an operator who is appropriately trained and experienced.

3. Do not service or attempt to remove product and machinery/equipment until safety is confirmed.

1. The inspection and maintenance of machinery/equipment should only be performed after measures to prevent falling or runaway of the driven objects have been confirmed.
2. When the product is to be removed, confirm that the safety measures as mentioned above are implemented and the power from any appropriate source is cut, and read and understand the specific product precautions of all relevant products carefully.
3. Before machinery/equipment is restarted, take measures to prevent unexpected operation and malfunction.

4. Our products cannot be used beyond their specifications. Our products are not developed, designed, and manufactured to be used under the following conditions or environments. Use under such conditions or environments is not covered.

1. Conditions and environments outside of the given specifications, or use outdoors or in a place exposed to direct sunlight.
2. Use for nuclear power, railways, aviation, space equipment, ships, vehicles, military application, equipment affecting human life, body, and property, fuel equipment, entertainment equipment, emergency shut-off circuits, press clutches, brake circuits, safety equipment, etc., and use for applications that do not conform to standard specifications such as catalogs and operation manuals.
3. Use for interlock circuits, except for use with double interlock such as installing a mechanical protection function in case of failure. Please periodically inspect the product to confirm that the product is operating properly.

Caution

We develop, design, and manufacture our products to be used for automatic control equipment, and provide them for peaceful use in manufacturing industries.

Use in non-manufacturing industries is not covered.

Products we manufacture and sell cannot be used for the purpose of transactions or certification specified in the Measurement Act.

The new Measurement Act prohibits use of any unit other than SI units in Japan.

Limited warranty and Disclaimer/ Compliance Requirements

The product used is subject to the following “Limited warranty and Disclaimer” and “Compliance Requirements”.

Read and accept them before using the product.

Limited warranty and Disclaimer

1. This product is warranted for a year after it is delivered. Also, even within the warranty period, the wear of a product due to the use of the vacuum pad or failure due to the deterioration of rubber material are not covered by the limited warranty.
2. For any failure or damage reported within the warranty period which is clearly our responsibility, a replacement product or necessary parts will be provided. This limited warranty applies only to our product independently, and not to any other damage incurred due to the failure of the product.

Compliance Requirements

1. The use of SMC products with production equipment for the manufacture of weapons of mass destruction (WMD) or any other weapon is strictly prohibited.
2. The exports of SMC products or technology from one country to another are governed by the relevant security laws and regulations of the countries involved in the transaction. Prior to the shipment of a SMC product to another country, assure that all local rules governing that export are known and followed.

 **Safety Instructions** Be sure to read the “Handling Precautions for SMC Products” (M-E03-3) and “Operation Manual” before use.

SMC Corporation