

3-Screen Display Sensor Monitor

New



Compatible with 5 types of pressure sensor



It is possible to change the settings while checking the measured value.

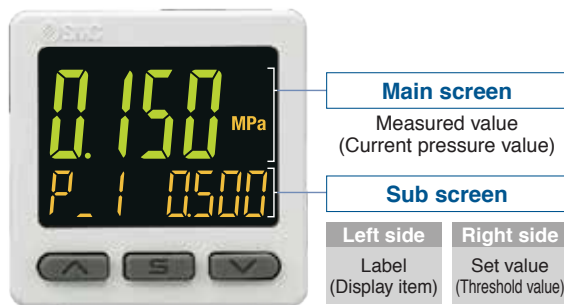

Visualization of Settings

| | | | |
|-----------------------------|------|------------------|------|
| Set value (Threshold value) | P.1 | Hysteresis value | H.1 |
| Peak value | H.H1 | Bottom value | H.Lo |

NPN/PNP Switch Function



1 sensor monitor for 2 output types reduces stock.

Input Range Selection (for Pressure/Flow rate)

- Set the displayed value according to the sensor input.
(Voltage input: 1 to 5 V/Current input: 4 to 20 mA)
- Value is displayed regardless of the pressure switch or flow switch.

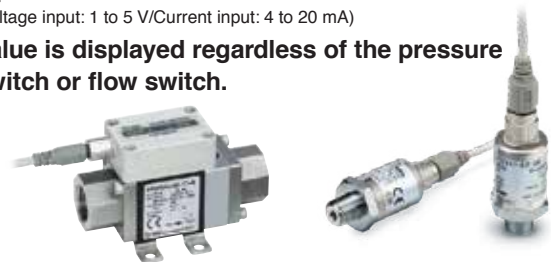

PSE300A Series

SMC
NAS100-126A

Improved Operability

Visualization of Settings

The sub screen (label) shows the item to be set.

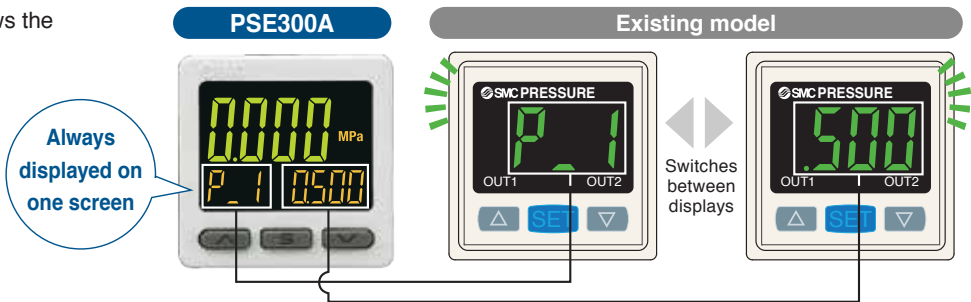

| Mode Examples | Hysteresis mode | | Normal output/ Lo side | | Reversed output/ Hi side | | Reversed output/ Lo side | | Reversed output/ Hi side | |
|---------------|----------------------------------|-----------------------------|----------------------------------|-----------------------------|------------------------------------|-----------------------------|------------------------------------|-----------------------------|------------------------------------|-----------------------------|
| | Normal output/ (Threshold value) | Set value (Threshold value) | Normal output/ (Threshold value) | Set value (Threshold value) | Reversed output/ (Threshold value) | Set value (Threshold value) | Reversed output/ (Threshold value) | Set value (Threshold value) | Reversed output/ (Threshold value) | Set value (Threshold value) |
| | P_1 | 0500 | P_1 | 0500 | H_1 | 0050 | P_L | 0300 | P_H | 0600 |
| | P_L | 0300 | P_H | 0600 | n_L | 0300 | n_H | 0600 | | |

Simple 3-Step Setting

When the S button is pressed and the set value (P_1) is being displayed, the set value (threshold value) can be set. When the S button is pressed and the hysteresis (H_1) is being displayed, the hysteresis value can be set.

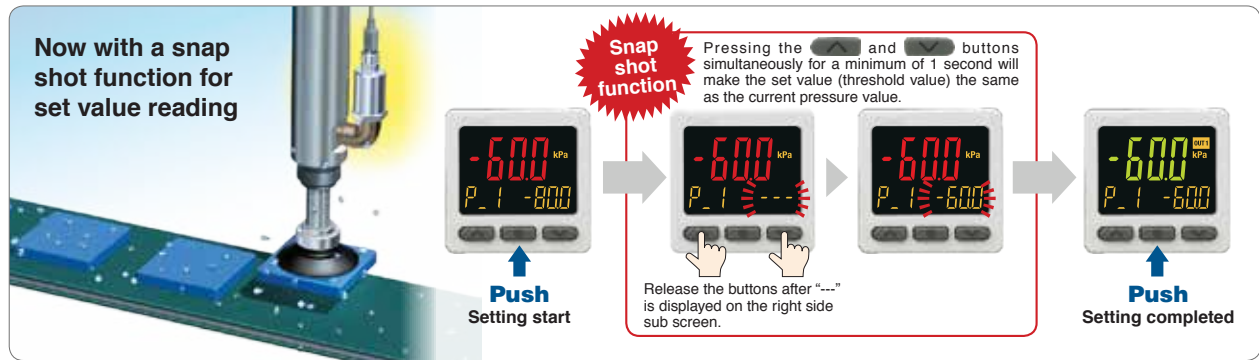
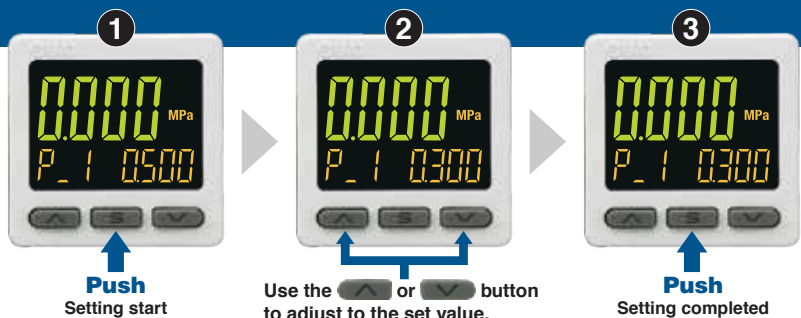

Easy Screen Switching

It is possible to change the settings while checking the measured value.

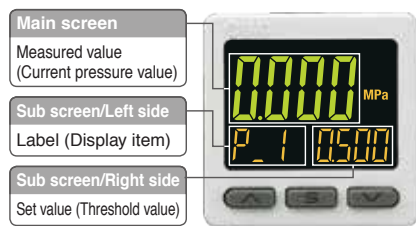

The sub screen can be switched by pressing the up/down buttons.



* One additional arbitrary display mode can be added via the function settings.

Copy Function

The settings of the master sensor can be copied to the slave sensors.

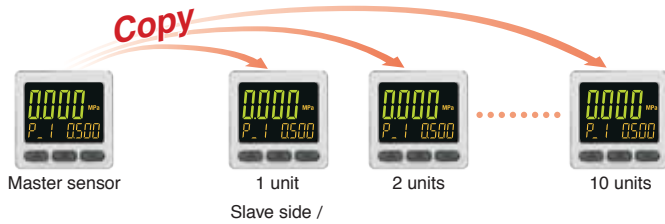

Easy Fitting of Connector

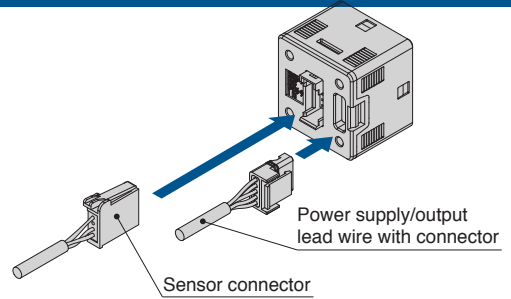

Input Range Selection (for Pressure/Flow rate)

The displayed value to the sensor input can be set as required.
(Voltage input: 1 to 5 V/Current input: 4 to 20 mA)
Pressure switch/Flow switch can be displayed.

A is displayed for 1 V (or 4 mA).
B is displayed for 5 V (or 20 mA).
The range can be set as required.

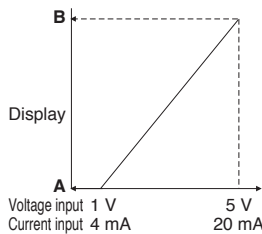

■ For Digital Flow Switch for Water/PF3W511

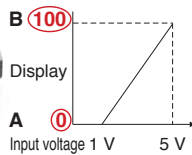

| | A | B |
|---------|---|-----|
| PF3W504 | 0 | 4 |
| PF3W520 | 0 | 16 |
| PF3W540 | 0 | 40 |
| PF3W511 | 0 | 100 |

Set A and B to the values shown in the table on the left.

Analog Free Span Function

For the displayed value, the analog span point (5 V, 20 mA) can be changed within the rated pressure range of 10 to 105%*1.

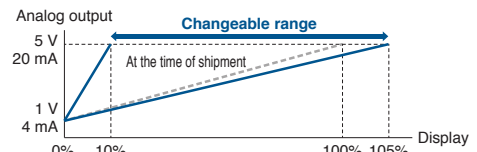

*1 Up to the upper limit of the display/set pressure range.

[Application example]

To output 5 V from the pressure controller at 0.75 MPa, using a sensor that outputs 1 to 5 V at 0 to 1 MPa.

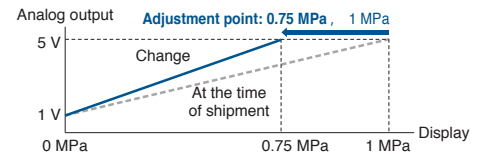

Application Example

Centralized control of distributed pressure switches is possible.

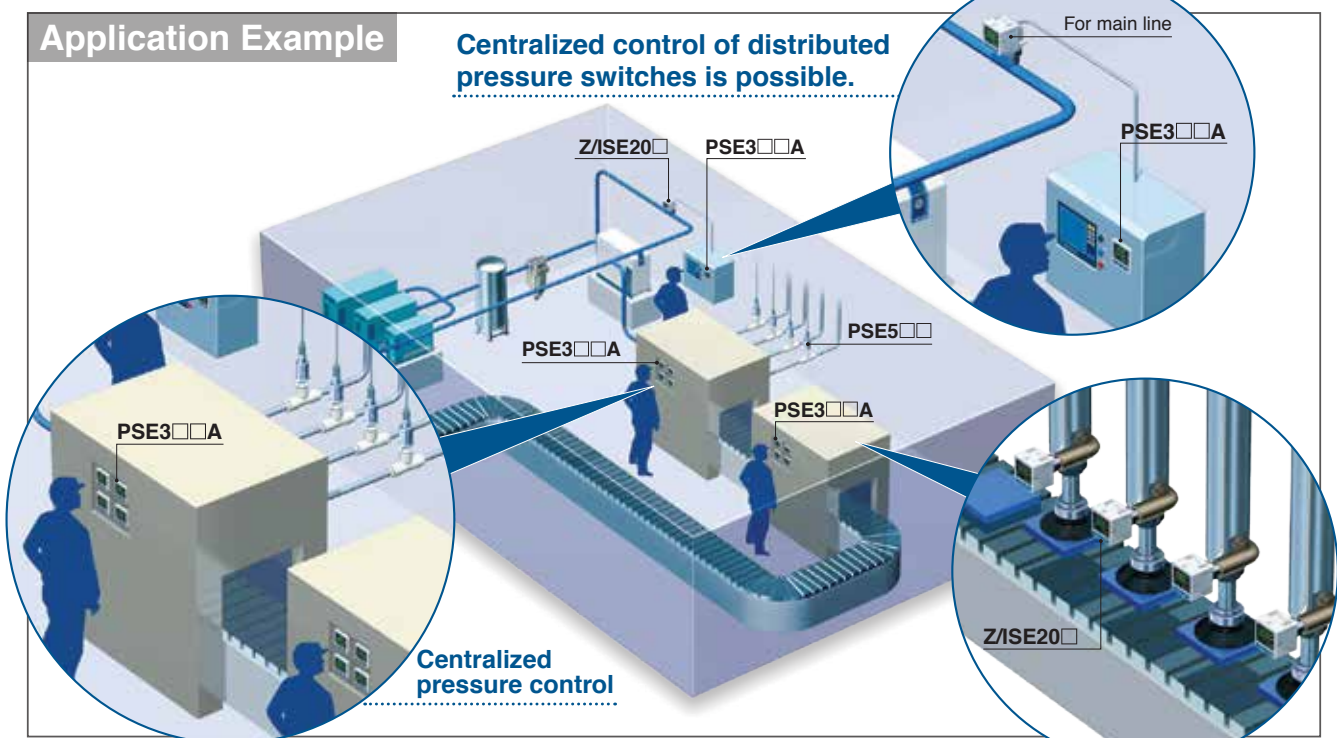

Series Variations

| | | Digital Sensor Monitor | | | | |
|-----------------------------|---|---|---|---|---|--|
| | | PSE300A | PSE200A | PSE300AC | | |
| | |  |  |  | | |
| Basic Specifications | Repeatability | ±0.1% (F.S.) | | ±0.1% (F.S.) | | |
| | Voltage | 12 to 24 VDC | | 12 to 24 VDC | | |
| | No. of outputs for switch | 2 outputs | 5 outputs | 2 outputs | | |
| | Analog output | 1 to 5 V 4 to 20 mA | — | | | |
| | Operating temperature | 0 to 50°C | | 0 to 50°C | | |
| Functions | Number of screens | 3 | 3 | | | |
| | Enclosure | IP40 | Front face: IP65 Others: IP40 | IP65 | | |
| | 3-step setting | Yes | Yes | | | |
| | Wiring | Connector | Connector | | | |
| Applicable Pressure Sensors | Refer to the Web Catalog for details. | Compact Pneumatic Pressure Sensor PSE53 □ | Compact Pneumatic Pressure Sensor PSE54 □ | Low Differential Pressure Sensor PSE550 | Pressure Sensor for General Fluids PSE56 □ | Pressure Sensor for General Fluids PSE57 □ |
| | |  |  |  |  |  |
| | | Rated pressure range | Rated pressure range | Rated pressure range | Rated pressure range | Rated pressure range |
| | | -101 kPa to 0 -100 kPa to 100 kPa 0 to 100 kPa 0 to 1 MPa | -101 kPa to 0 -100 kPa to 100 kPa 0 to 1 MPa | 0 to 2 kPa | -101 kPa to 0 -100 kPa to 100 kPa 0 to 500 kPa 0 to 1 MPa | -100 kPa to 100 kPa 0 to 500 kPa 0 to 1 MPa 0 to 2 MPa 0 to 5 MPa 0 to 10 MPa |

CONTENTS

| | | | |
|------------------------|------|---|-------|
| How to Order | p. 4 | Internal Circuits and Wiring Examples | p. 6 |
| Options/Part Nos. | p. 4 | Dimensions | p. 7 |
| Specifications | p. 5 | Function Details | p. 10 |



How to Order

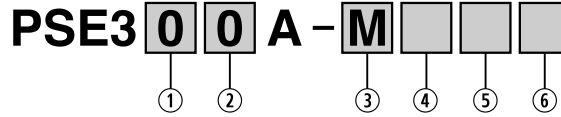

① **Input specification**

| Symbol | Description |
|----------|---------------|
| 0 | Voltage input |
| 1 | Current input |

② **Output specification**

| Symbol | Description | Factory default settings |
|----------|---|---|
| 0 | NPN/PNP open collector 2 outputs switching type + Analog voltage/Auto-shift/Copy function | NPN open collector 2 outputs + Analog voltage*1 |
| 3 | switching type | PNP open collector 2 outputs + Analog voltage*1 |
| 1 | NPN/PNP open collector 2 outputs switching type + Analog current/Auto-shift/Copy function | NPN open collector 2 outputs + Analog current*2 |
| 4 | switching type | PNP open collector 2 outputs + Analog current*2 |
| 6 | NPN/PNP open collector 2 outputs switching type + Copy function | NPN open collector 2 outputs + Copy function |

*1, 2 Although the default output specifications differ, the output specifications are the same.

③ **Unit specification**

| Symbol | Description |
|------------|--------------------------------|
| Nil | With unit selection function*1 |
| M | SI units only*2 |

*1 Under the New Measurement Act, switches with the unit selection function are no longer allowed for use in Japan.

*2 Fixed unit: MPa, kPa, Pa

④ **Option 1**

| Symbol | Description |
|------------|--|
| Nil | Without lead wire |
| L | Lead wire with connector (2 m lead wire) |

ZS-46-5L

Power supply/output lead wire with connector

⑥ **Option 3**

| Symbol | Description |
|------------|------------------|
| Nil | None |
| C | Sensor connector |

ZS-28-C

Sensor connector

⑤ **Option 2**

| Symbol | Description |
|------------|--|
| Nil | None |
| A | Bracket |
| B | Panel mount adapter |
| D | Panel mount adapter + Front protection cover |

ZS-46-A1

ZS-46-B

Panel

Panel mount adapter

ZS-46-D

Panel

Front protection cover

Panel mount adapter

Options/Part Nos.

When only optional parts are required, order with the part numbers listed below.

| Description | Part no. | Note |
|--|-----------------|-------------|
| Bracket | ZS-46-A1 | — |
| Panel mount adapter | ZS-46-B | — |
| Panel mount adapter + Front protection cover | ZS-46-D | — |
| Lead wire with connector | ZS-46-5L | 5-core, 2 m |
| Front protection cover | ZS-27-01 | — |
| Sensor connector | ZS-28-C | — |

For pressure switch precautions and specific product precautions, refer to the "Operation Manual" on the SMC website.

Specifications

| Series | | PSE300A | | | | | | | | | |
|-------------------------------------|---|---|---|--------------------------------------|----------------|------------------|--------------------------------------|-------------------|-------------------|-------------------|--|
| Applicable SMC pressure sensor | | PSE550 | PSE531 PSE541 PSE561 | PSE533 PSE543 PSE563 PSE573 | PSE532 | PSE564 PSE574 | PSE530 PSE540 PSE560 PSE570 | PSE575 | PSE576 | PSE577 | |
| Rated pressure range | | 0 to 2 kPa | 0 to -101 kPa | -100 to 100 kPa | 0 to 100 kPa | 0 to 500 kPa | 0 to 1 MPa | 0 to 2 MPa | 0 to 5 MPa | 0 to 10 MPa | |
| Display/Set pressure range | | -0.2 to 2.1 kPa | 10 to -105 kPa | -105 to 105 kPa | -10 to 105 kPa | -50 to 525 kPa | -0.105 to 1.05 MPa | -0.105 to 2.1 MPa | -0.25 to 5.25 MPa | -0.50 to 10.5 MPa | |
| Display/Smallest settable increment | | 0.001 kPa | 0.1 kPa | 0.1 kPa | 0.1 kPa | 1 kPa | 0.001 MPa | 0.001 MPa | 0.01 MPa | 0.01 MPa | |
| Electrical | Power supply voltage | 12 to 24 VDC ±10%, Ripple (p-p) 10% or less | | | | | | | | | |
| | Current consumption | 35 mA or less | | | | | | | | | |
| | Protection | Polarity protection | | | | | | | | | |
| Accuracy | Display accuracy | ±0.5% F.S. ±1 digit (Ambient temperature of 25°C) | | | | | | | | | |
| | Repeatability | ±0.1% F.S. ±1 digit | | | | | | | | | |
| | Analog output accuracy (To display value) | ±0.5% F.S. | | | | | | | | | |
| | Analog output linearity | ±0.2% F.S. | | | | | | | | | |
| | Temperature characteristics | ±0.5% F.S. (Reference: 25°C) | | | | | | | | | |
| Switch output | Output type | Select from NPN or PNP open collector 2 outputs. | | | | | | | | | |
| | Output mode | Select from Hysteresis, Window comparator, Error output, or Switch output OFF modes. | | | | | | | | | |
| | Switch operation | Select from Normal or Reversed output. | | | | | | | | | |
| | Max. load current | 80 mA | | | | | | | | | |
| | Max. applied voltage (NPN only) | 30 VDC | | | | | | | | | |
| | Internal voltage drop (Residual voltage) | NPN: 1 V or less (at load current of 80 mA) PNP: 1.5 V or less (at load current of 80 mA) | | | | | | | | | |
| | Delay time*1 | 1.5 ms or less (with anti-chattering function: 20, 100, 500, 1000, 2000, 5000 ms) | | | | | | | | | |
| | Hysteresis | Hysteresis mode | Variable from 0*2 | | | | | | | | |
| | | Window comparator mode | | | | | | | | | |
| | Protection | Over current protection | | | | | | | | | |
| Analog output | Voltage output | Output type*3 | Voltage output: 1 to 5 V Extension analog output range: 0.6 to 1 V | | | | | | | | |
| | | Output impedance | Approx. 1 kΩ | | | | | | | | |
| | Current output | Output type*3 | Current output: 4 to 20 mA Extension analog output range: 2.4 to 4 mA | | | | | | | | |
| | | Load impedance | Maximum load impedance at power supply voltage of 12 V: 300 Ω at power supply voltage of 24 V: 600 Ω Minimum load impedance: 50 Ω | | | | | | | | |
| Analog response time | | 50 ms or less | | | | | | | | | |
| Auto-shift input | Input type | Non-voltage input: 0.4 V or less | | | | | | | | | |
| | Input mode | Select from Auto-shift or Auto-shift zero. | | | | | | | | | |
| | Input time | 5 ms or more | | | | | | | | | |
| Sensor input | Input type | PSE30□A: Voltage input 1 to 5 VDC (Input impedance: 1 MΩ) PSE31□A: Current input 4 to 20 mA DC (Input impedance: 51 Ω) | | | | | | | | | |
| | Number of inputs | 1 input | | | | | | | | | |
| | Connection method | Connector (e-CON) | | | | | | | | | |
| | Protection | Over voltage protection (up to a voltage of 26.4 V) | | | | | | | | | |
| Display | Unit*4 | MPa, kPa, Pa, kgf/cm ² , bar, mbar, psi, inHg, mmHg, mmH ₂ O | | | | | | | | | |
| | Display type | LCD | | | | | | | | | |
| | Number of screens | 3-screen display (Main screen, Sub screen x 2) | | | | | | | | | |
| | Display color | 1) Main screen: Red/Green 2) Sub screen: Orange | | | | | | | | | |
| | Number of display digits | 1) Main screen: 4 digits (7 segments) 2) Sub screen: 4 digits (Upper 1 digit 11 segments, 7 segments for other) | | | | | | | | | |
| | Indicator light | Lights up when switch output is turned ON. OUT1, OUT2: Orange | | | | | | | | | |
| Digital filter*5,*6 | | 0, 10, 50, 100, 500, 1000, 5000 ms | | | | | | | | | |
| Environment | Enclosure | IP40 | | | | | | | | | |
| | Withstand voltage | 1000 VAC for 1 minute between terminals and housing | | | | | | | | | |
| | Insulation resistance | 50 MΩ or more (500 VDC measured via megohmmeter) between terminals and housing | | | | | | | | | |
| | Operating temperature range | Operating: 0 to 50°C, Stored: -10 to 60°C (No freezing or condensation) | | | | | | | | | |
| | Operating humidity range | Operating/Stored: 35 to 85% RH (No condensation) | | | | | | | | | |
| Standards | | UL/CSA (E216656), CE marking (EMC Directive, RoHS Directive) | | | | | | | | | |
| Weight | Body | 25 g (Excludes power supply and output lead wires) | | | | | | | | | |
| | Lead wire with connector | +39 g | | | | | | | | | |

*1 Value without digital filter (at 0 ms)

*2 If the sensor input fluctuates around the set value, the hysteresis must be set to a value more than the amount of fluctuation, or chattering will occur.

*3 If the connected sensor does not have an extended analog output range, there is no extended analog output range available for this product.

*4 This setting is only possible for models with the unit selection function. Only MPa, kPa, or Pa is available for models without this function (set by pressure range).

*5 The response time indicates when the set value is 90% in relation to the step input.

*6 Display, switch output and analog response time are affected.

* Products with tiny scratches, marks, or display color or brightness variations which do not affect the performance of the product are verified as conforming products.

Internal Circuits and Wiring Examples

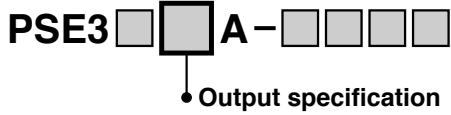

| Output specification | Settable circuit | Factory default settings |
|----------------------|------------------|--------------------------|
| 0 | ①, ②, ③, ④, ⑤, ⑥ | ③ |
| 1 | ①, ②, ③, ④, ⑤, ⑥ | ③ |
| 3 | ①, ②, ③, ④, ⑤, ⑥ | ④ |
| 4 | ①, ②, ③, ④, ⑤, ⑥ | ④ |
| 6 | ①, ② | ① |

① NPN (2 outputs) + Copy function setting

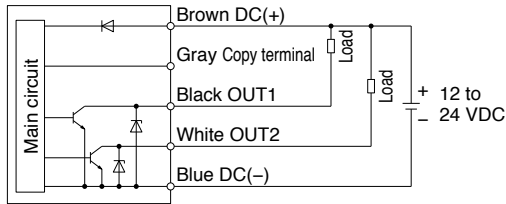

② PNP (2 outputs) + Copy function setting

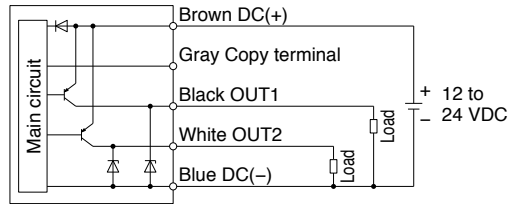

③ NPN (2 outputs) + Analog voltage output setting
NPN (2 outputs) + Analog current output setting

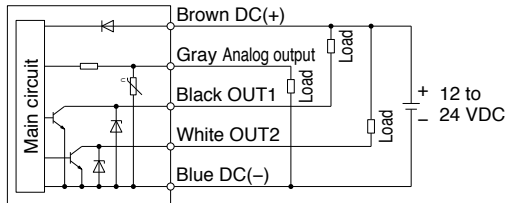

④ PNP (2 outputs) + Analog voltage output setting
PNP (2 outputs) + Analog current output setting

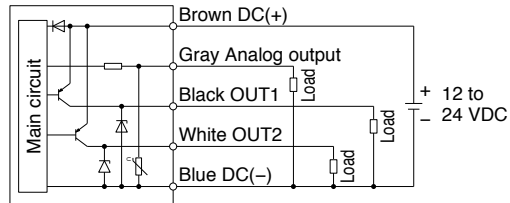

⑤ NPN (2 outputs) + Auto-shift input setting

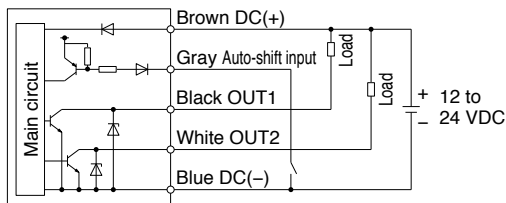

⑥ PNP (2 outputs) + Auto-shift input setting

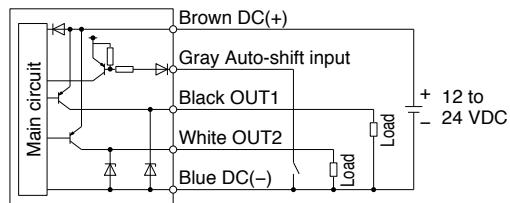

Sensor connector connection

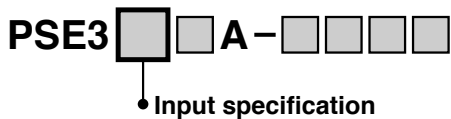

| Pin no. | Terminal | | |
|---------|--|--|-----------------------------|
| | PSE30 A (Voltage input) | PSE31 A (Current input) | |
| | | Pressure sensor 2-wire type | Pressure sensor 3-wire type |
| 1 | DC (+)(Brown) | DC (-)(Brown) | DC (+)(Brown) |
| 2 | N.C. | N.C. | N.C. |
| 3 | DC (-)(Blue) | N.C. | DC (-)(Blue) |
| 4 | IN (1 to 5 V)(Black) | IN (4 to 20 mA)(Blue) | IN (4 to 20 mA)(Black) |

* The colors in () indicate the wire color of the PSE5 series.

Dimensions

PSE3 A -

Option 2

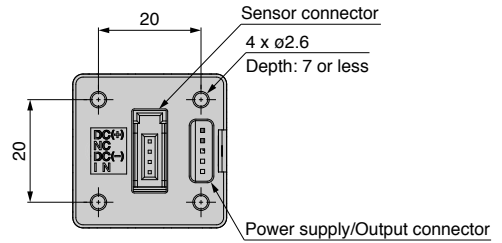
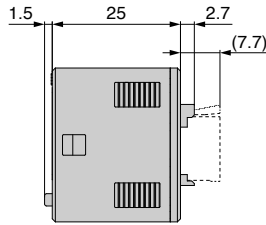
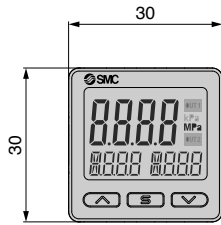

A

Bracket
(Part no.: ZS-46-A1)

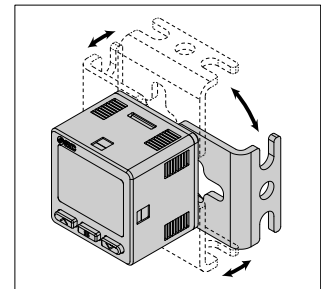
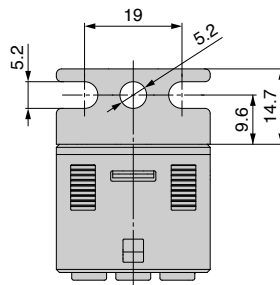
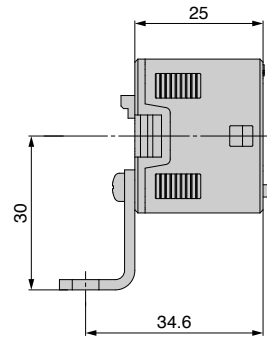
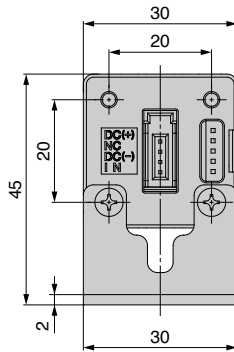

* The bracket configuration allows for mounting in four orientations.

B

Panel mount adapter
(Part no.: ZS-46-B)

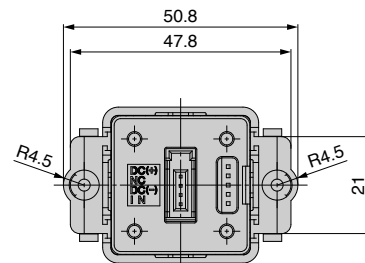
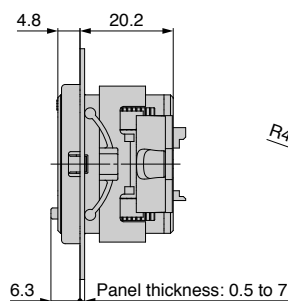
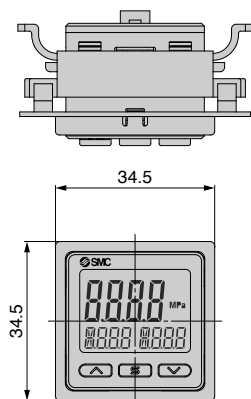

Dimensions

D

Panel mount adapter + Front protection cover (Part no.: ZS-46-D)

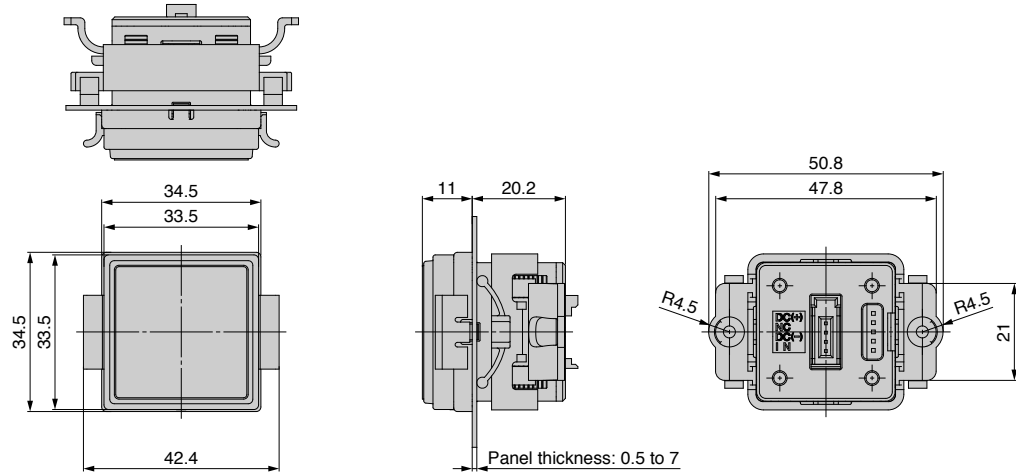

Lead wire with connector (Part no.: ZS-46-5L)

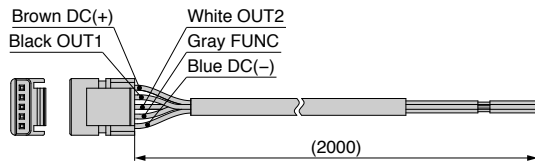

Cable Specifications

| | | |
|----------------|------------------------------|--|
| Conductor area | 0.15 mm ² (AWG26) | |
| Insulator | O.D. | 1.0 mm |
| | Color | Brown, Blue, Black, White, Gray (5-core) |
| Sheath | Finished O.D. | ø3.5 |

Dimensions

Panel fitting dimensions

Individual mounting

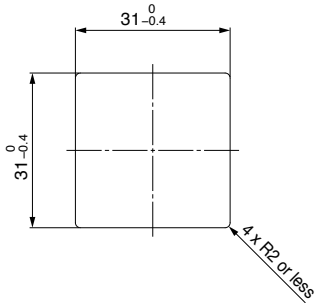

Multiple (2 pcs. or more) secure mounting <Horizontal>

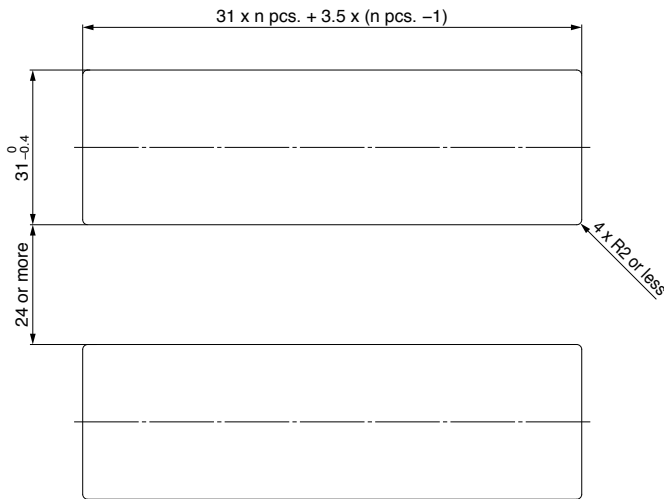

Panel mount example <Horizontal>

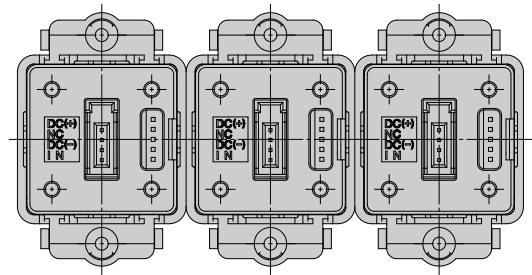

<Vertical>

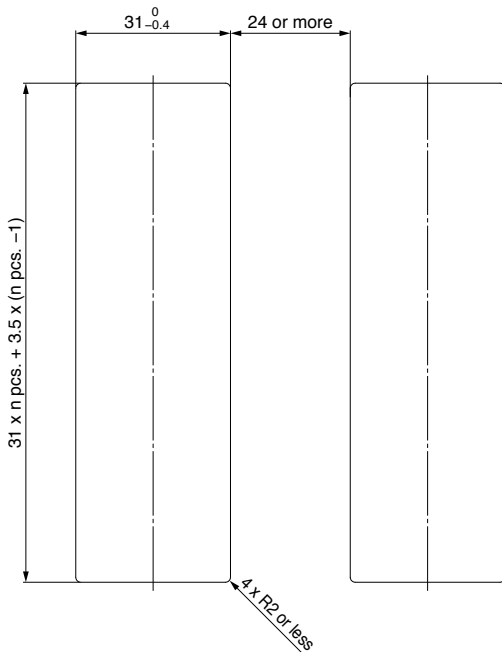

Panel mount example <Vertical>

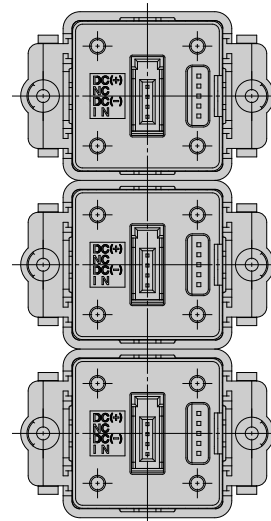

Display examples of the main and sub (set value) screens of each mode.

Hysteresis mode, Normal output

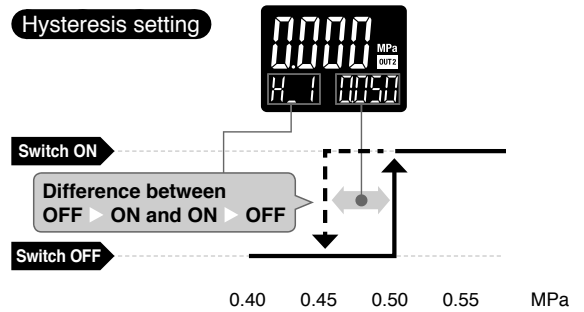
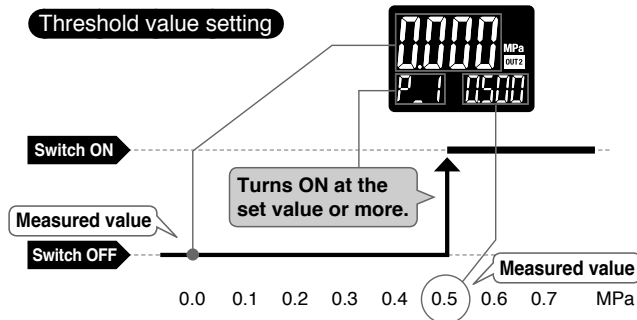

Hysteresis mode, Reversed output

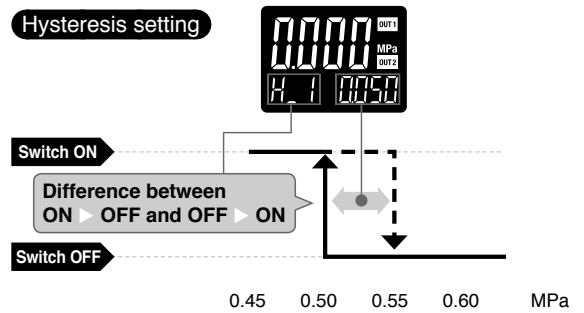
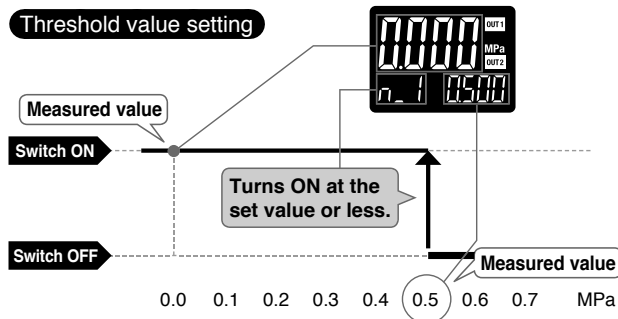

Window comparator mode, Normal output

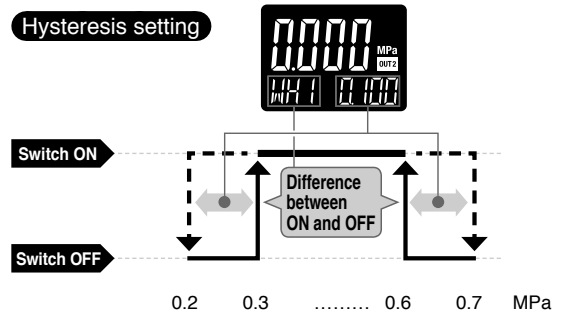
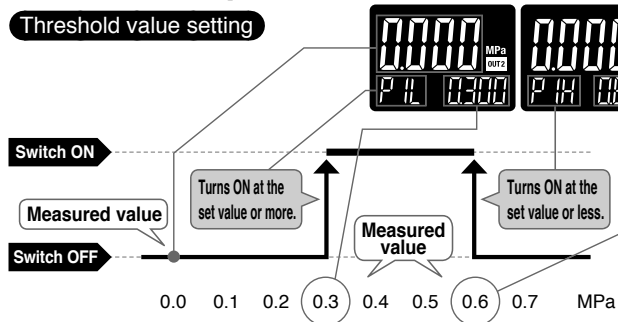

Window comparator mode, Reversed output

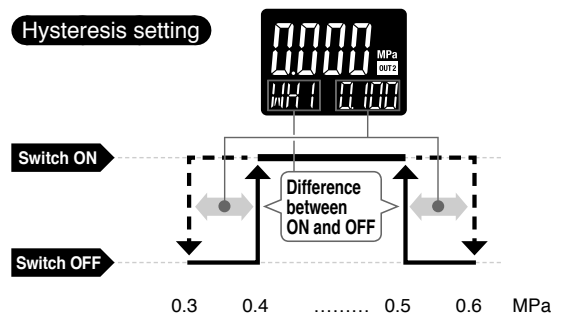
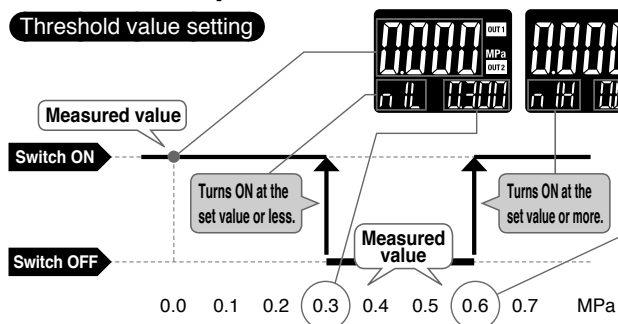

The \square in () shows the function code number. Refer to the operation manual for details on operation procedures and function codes.

Function Details

A Auto-preset function (F4)

This function, when selected in the initial setting, calculates and stores the set value from the measured pressure. For example, if this function is used for suction verification, the optimum set value is determined automatically by repeating vacuum and break with the target workpiece several times.

Suction Verification

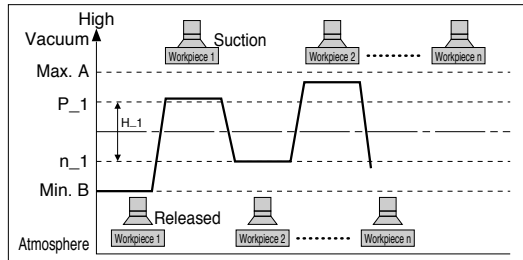

Formula for Obtaining the Set Value

| P ₁ or P ₂ | H ₁ or H ₂ |
|----------------------------------|----------------------------------|
| $P_1(P_2)=A-(A-B)/4$ | $H_1(H_2)=(A-B)/2$ |
| $n_1(n_2)=B+(A-B)/4$ | |

B Display value fine adjustment function (F6)

Fine adjustment of the indicated value of the pressure sensor can be made within the range of $\pm 5\%$ of the read value. (This eliminates wide variations of the indicated value.)

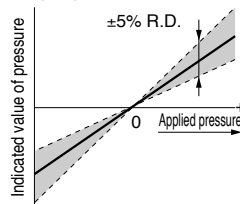

— Indicated value at the time of shipment
 ■ Adjustable range of display value fine adjustment function

* When the display value fine adjustment function is used, the set pressure value may change ± 1 digit.

C Peak/Bottom value indication function

This function constantly detects and updates the maximum (minimum) pressure when the power is supplied, and allows to hold the maximum (minimum) pressure value.

The held value is maintained even if the power supply is cut.

When the \square and \square buttons are simultaneously pressed for 1 second or longer, while "holding", the held value will be reset.

D Key-lock function

This function prevents operation errors such as accidentally changing setting values.

E Zero-clear function

This function clears and resets the zero value on the display of measured pressure. The indicated value can be adjusted within $\pm 7\%$ F.S. of the pressure at the time of factory shipment. ($\pm 3.5\%$ F.S. for compound pressure)

F Error display function

This function displays error location and content when a problem or error has occurred.

| Error name | Error code | Description | Action |
|-------------------------|---|--|--|
| Over current error | \square Er 1 \square Er 2 of 1 of 2 | Load current of 80 mA or more is applied to the switch output. | Turn the power off and remove the cause of the over current. Then supply the power again. |
| Residual pressure error | \square Er 3 Err | During zero-clear operation, pressure over $\pm 7\%$ F.S. ($\pm 3.5\%$ F.S. for compound pressure) is present. Note that the mode is returned to measurement mode automatically 1 second later. The zero-clear range varies by $\pm 1\%$ F.S. due to variation between individual products. | Perform zero-clear operation again after restoring the applied pressure to an atmospheric pressure condition. |
| Applied pressure error | \square H H H | Supply pressure exceeds the maximum set pressure. | Reset applied pressure to a level within the set pressure range. Check the sensor connection. |
| | \square L L L | Supply pressure is below the minimum set pressure. A sensor may be disconnected or mis-wired. | |
| System error | \square Er 0 \square Er 7 \square Er 4 \square Er 8 \square Er 6 \square Er 9 | Internal data error | Turn the power off and then on again. If the failure cannot be solved, please contact SMC for investigation. |
| Copy error | \square Er 13 St. Pr | The copy function does not operate properly. | After clearing the error by pressing the \square and \square buttons simultaneously for a minimum of 1 second, check the wiring and the model, and then attempt to copy again. |

If the error cannot be reset after the above measures are taken, or errors other than those above are displayed, please contact SMC for investigation.

Function Details

The \square in () shows the function code number. Refer to the operation manual for details on operation procedures and function codes.

G Anti-chattering function (Simple setting mode or F1)

A large bore cylinder or ejector consumes a large volume of air during operation and may experience a temporary drop in the supply pressure. This function prevents the detection of such temporary drops in the supply pressure as errors by changing the delay time setting.

| Available delay time settings |
|--|
| 1.5 ms or less, 20 ms, 100 ms, 500 ms, 1000 ms, 2000 ms, 5000 ms |

<Principle>

This function averages pressure values measured during the response time set by the user and then compares the average pressure value with the pressure set point value to output the result on the switch.

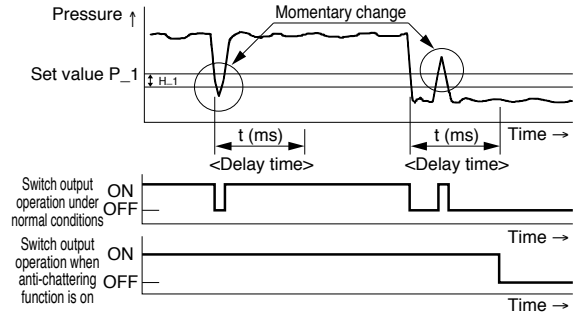

H Unit selection function (F0)

Display units can be switched with this function.

| Display unit Smallest settable increment | Rated pressure range | Display/ Set pressure range | MPa | kPa | Pa | kgf/cm ² | bar | mbar | psi | inHg | mmHg | mmH ₂ O | |
|---|----------------------|-----------------------------|---------------------|-------|-------|---------------------|-------|-------|------|-------|------|--------------------|-----|
| | | | MPa | kPa | Pa | kgf/cm ² | bar | mbar | psi | inHg | mmHg | mmH ₂ O | |
| Applicable SMC pressure sensor | PSE550 | 0 to 2 kPa | -0.200 to 2.100 kPa | 0.001 | 0.001 | 1 | 0.001 | 0.001 | 0.01 | 0.001 | 0.1 | 0.1 | |
| | PSE531 | 0 to -101 kPa | 10.0 to -105.0 kPa | 0.001 | 0.1 | 1 | 0.001 | 0.001 | 0.01 | 0.1 | 1 | 0.1 | |
| | PSE541 | | | | | | | | | | | | |
| | PSE561 | | | | | | | | | | | | |
| | PSE533 | -100 to 100 kPa | -105.0 to 105.0 kPa | 0.001 | 0.1 | 1 | 0.001 | 0.001 | 0.01 | 0.1 | 1 | 0.1 | |
| | PSE543 | | | | | | | | | | | | |
| | PSE563 | | | | | | | | | | | | |
| | PSE573 | 0 to 100 kPa | -10.0 to 105.0 kPa | 0.001 | 0.1 | 1 | 0.001 | 0.001 | 0.01 | 0.1 | 1 | 0.1 | |
| | PSE532 | | | | | | | | | | | | |
| | PSE564 | 0 to 500 kPa | -50 to 525 kPa | 0.001 | 1 | 1 | 0.01 | 0.01 | 0.1 | 0.1 | 1 | 0.1 | |
| | PSE574 | | | | | | | | | | | | |
| | PSE530 | 0 to 1 MPa | -0.105 to 1.050 MPa | 0.001 | 1 | 1 | 0.01 | 0.01 | 0.1 | 0.1 | 1 | 0.1 | 0.1 |
| | PSE540 | | | | | | | | | | | | |
| PSE560 | | | | | | | | | | | | | |
| PSE570 | | | | | | | | | | | | | |
| PSE575 | 0 to 2 MPa | -0.105 to 2.100 MPa | 0.001 | 1 | 1 | 0.01 | 0.01 | 0.1 | 0.1 | 1 | 0.1 | | |
| PSE576 | 0 to 5 MPa | -0.25 to 5.25 MPa | 0.01 | 1 | 1 | 0.1 | 0.1 | 1 | 1 | 1 | 1 | | |
| PSE577 | 0 to 10 MPa | -0.50 to 10.50 MPa | 0.01 | 1 | 1 | 0.1 | 0.1 | 1 | 1 | 1 | 1 | | |
| Additional range | 0 to 20 MPa | -1.00 to 21.00 MPa | 0.01 | 1 | 1 | 0.1 | 0.1 | 1 | 1 | 1 | 1 | | |
| | 0 to 25 MPa | -1.26 to 26.26 MPa | 0.02 | 1 | 1 | 0.2 | 0.2 | 1 | 1 | 1 | 1 | | |

It varies depending on the smallest settable increment of the additional range.

I Input range selection (F0)

Display value can be set by user according to the sensor input (voltage input: 1 to 5 V, current input: 4 to 20 mA).

* The display and analog output are interlocked, so if one is changed the other will change.

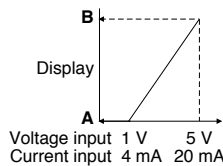

J Power-saving mode (F80)

Power-saving mode can be selected.

It shifts to power-saving mode automatically when there is no button operation for 30 seconds.

The product is set to normal mode (Power-saving mode is OFF) at the time of factory shipment.

(When in power-saving mode, [ECo] will flash in the sub screen and the operation light will be ON (only when the switch is ON).)

K Setting of security code (F81)

Users can select whether a security code must be entered to release the key lock.

At the time of factory shipment, it is set so that a security code is not required.

Function Details

L Copy function (F97)

The settings of the master sensor can be copied to the slave sensors, reducing setting labor and minimizing the risk of setting mistakes.

The set value can be copied to up to 10 sensors simultaneously. (Maximum transmission distance: 4 m)

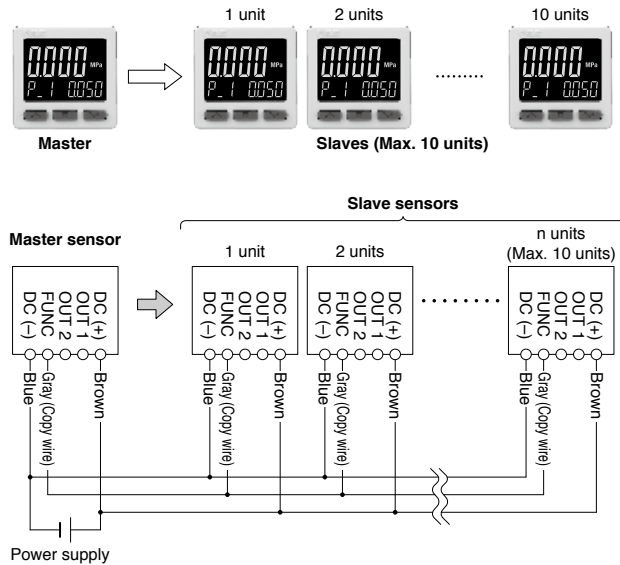

- 1) Wire as shown in the figure above.
- 2) Select the slave sensor which is to be the master, and change it into a master using the buttons. (In the default setting, all sensors are set as slaves.)
- 3) Press the **S** button on the master sensor to start copying.

N Analog free span function (F5)

For the displayed value, the analog span point (5 V, 20 mA) can be changed within the rated pressure range of 10 to 105%*1.

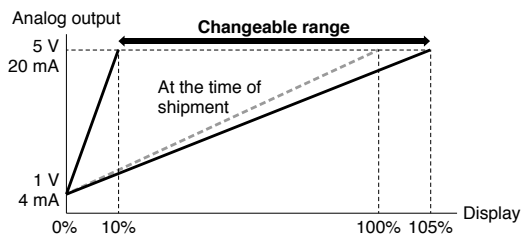

*1 Up to the upper limit of the display/set pressure range

The \square in () shows the function code number. Refer to the operation manual for details on operation procedures and function codes.

M Auto-shift function (F5)

When there are large fluctuations in the supply pressure, the switch may fail to operate correctly.

This function compensates for such supply pressure fluctuations. It measures the pressure at the time of auto-shift signal input and uses it as the reference pressure to correct the set value on the switch.

Set value correction by auto-shift function

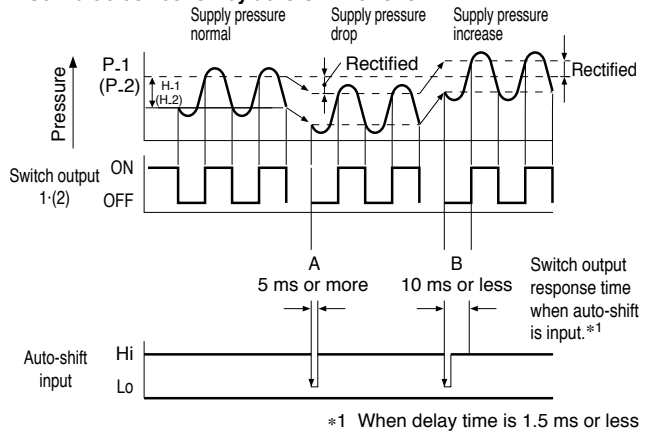

When the auto-shift function is selected, "P5 in 000" will be displayed on the sub screen for about 1 second, and the pressure value at that point will be saved as reference value "L5". Based on the saved reference value, output on-off points controlled by set values*2 such as "P-1", "H-1", "P-2", and "H-2" will also be rectified.

*2 When an output is reversed, output on-off points displayed at "n-1", "H-1", "n-2", and "H-2" will be rectified.

The above is an example in hysteresis mode. On-off points are similarly rectified in window comparator mode. Outputs that enable the auto-shift function can be changed via the settings.

Settable Range for Auto-Shift Input

| Range settings | Settable range |
|-----------------|---------------------|
| 0 to 2 kPa | -2.30 to 2.300 kPa |
| 0 to -101 kPa | 115.0 to -115.0 kPa |
| -100 to 100 kPa | -210 to 210.0 kPa |
| 0 to 100 kPa | -115.0 to 115.0 kPa |
| 0 to 500 kPa | -575 to 575 kPa |
| 0 to 1 MPa | -1.155 to 1.155 MPa |
| 0 to 2 MPa | -2.20 to 2.205 MPa |
| 0 to 5 MPa | -5.50 to 5.50 MPa |
| 0 to 10 MPa | -11.00 to 11.00 MPa |
| 0 to 20 MPa | -22.0 to 22.00 MPa |
| 0 to 25 MPa | -27.5 to 27.52 MPa |

Auto-shift zero

The basic function of auto-shift zero is the same as that of auto-shift. However, it corrects values on the display based on a pressure value of "0", which is set as the reference value when auto-shift function is selected.

Safety Instructions

These safety instructions are intended to prevent hazardous situations and/or equipment damage. These instructions indicate the level of potential hazard with the labels of “Caution,” “Warning” or “Danger.” They are all important notes for safety and must be followed in addition to International Standards (ISO/IEC)*1), and other safety regulations.

 **Caution:** Caution indicates a hazard with a low level of risk which, if not avoided, could result in minor or moderate injury.

 **Warning:** Warning indicates a hazard with a medium level of risk which, if not avoided, could result in death or serious injury.

 **Danger:** Danger indicates a hazard with a high level of risk which, if not avoided, will result in death or serious injury.

*1) ISO 4414: Pneumatic fluid power – General rules relating to systems.
 ISO 4413: Hydraulic fluid power – General rules relating to systems.
 IEC 60204-1: Safety of machinery – Electrical equipment of machines.
 (Part 1: General requirements)
 ISO 10218-1: Manipulating industrial robots – Safety.
 etc.

Warning

1. The compatibility of the product is the responsibility of the person who designs the equipment or decides its specifications.

Since the product specified here is used under various operating conditions, its compatibility with specific equipment must be decided by the person who designs the equipment or decides its specifications based on necessary analysis and test results. The expected performance and safety assurance of the equipment will be the responsibility of the person who has determined its compatibility with the product. This person should also continuously review all specifications of the product referring to its latest catalog information, with a view to giving due consideration to any possibility of equipment failure when configuring the equipment.

2. Only personnel with appropriate training should operate machinery and equipment.

The product specified here may become unsafe if handled incorrectly. The assembly, operation and maintenance of machines or equipment including our products must be performed by an operator who is appropriately trained and experienced.

3. Do not service or attempt to remove product and machinery/equipment until safety is confirmed.

1. The inspection and maintenance of machinery/equipment should only be performed after measures to prevent falling or runaway of the driven objects have been confirmed.
2. When the product is to be removed, confirm that the safety measures as mentioned above are implemented and the power from any appropriate source is cut, and read and understand the specific product precautions of all relevant products carefully.
3. Before machinery/equipment is restarted, take measures to prevent unexpected operation and malfunction.

4. Contact SMC beforehand and take special consideration of safety measures if the product is to be used in any of the following conditions.

1. Conditions and environments outside of the given specifications, or use outdoors or in a place exposed to direct sunlight.
2. Installation on equipment in conjunction with atomic energy, railways, air navigation, space, shipping, vehicles, military, medical treatment, combustion and recreation, or equipment in contact with food and beverages, emergency stop circuits, clutch and brake circuits in press applications, safety equipment or other applications unsuitable for the standard specifications described in the product catalog.
3. An application which could have negative effects on people, property, or animals requiring special safety analysis.
4. Use in an interlock circuit, which requires the provision of double interlock for possible failure by using a mechanical protective function, and periodical checks to confirm proper operation.

Caution

1. The product is provided for use in manufacturing industries.

The product herein described is basically provided for peaceful use in manufacturing industries.
 If considering using the product in other industries, consult SMC beforehand and exchange specifications or a contract if necessary.
 If anything is unclear, contact your nearest sales branch.

Limited warranty and Disclaimer/ Compliance Requirements

The product used is subject to the following “Limited warranty and Disclaimer” and “Compliance Requirements”.

Read and accept them before using the product.

Limited warranty and Disclaimer

1. The warranty period of the product is 1 year in service or 1.5 years after the product is delivered, whichever is first.*2)
2. For any failure or damage reported within the warranty period which is clearly our responsibility, a replacement product or necessary parts will be provided. This limited warranty applies only to our product independently, and not to any other damage incurred due to the failure of the product.
3. Prior to using SMC products, please read and understand the warranty terms and disclaimers noted in the specified catalog for the particular products.

***2) Vacuum pads are excluded from this 1 year warranty.**

A vacuum pad is a consumable part, so it is warranted for a year after it is delivered. Also, even within the warranty period, the wear of a product due to the use of the vacuum pad or failure due to the deterioration of rubber material are not covered by the limited warranty.

Compliance Requirements

1. The use of SMC products with production equipment for the manufacture of weapons of mass destruction (WMD) or any other weapon is strictly prohibited.
2. The exports of SMC products or technology from one country to another are governed by the relevant security laws and regulations of the countries involved in the transaction. Prior to the shipment of a SMC product to another country, assure that all local rules governing that export are known and followed.

Caution

SMC products are not intended for use as instruments for legal metrology.

Measurement instruments that SMC manufactures or sells have not been qualified by type approval tests relevant to the metrology (measurement) laws of each country. Therefore, SMC products cannot be used for business or certification ordained by the metrology (measurement) laws of each country.

Safety Instructions

Be sure to read the “Handling Precautions for SMC Products” (M-E03-3) and “Operation Manual” before use.

UNIT CONVERSIONS

| | unit | conversion | result | | unit | conversion | result |
|--------|-----------------|------------|--------|-------------|-------|-------------------|--------|
| length | m | x 3.28 | psi | pressure | MPa | x 145 | psi |
| | mm | x 0.04 | psi | | kPa | ÷ 6.895 | psi |
| mass | g | x 0.04 | °F | temperature | °C | x 1.8 then add 32 | °F |
| volume | cm ³ | ÷ 16.387 | ft-lb | torque | N·m | x 0.738 | ft-lb |
| | L | x 61.024 | lbf | force | N | ÷ 4.448 | lbf |
| speed | mm/s | ÷ 25.4 | cfm | flow | L/min | ÷ 28.317 | cfm |

Global Manufacturing, Distribution and Service Network

Worldwide Subsidiaries

EUROPE

AUSTRIA
SMC Pneumatik GmbH (Austria)

BELGIUM
SMC Pneumatics N.V./S.A.

BULGARIA
SMC Industrial Automation Bulgaria EOOD

CROATIA
SMC Industrijska Automatika d.o.o.

CZECH REPUBLIC
SMC Industrial Automation CZ s.r.o.

DENMARK
SMC Pneumatik A/S

ESTONIA
SMC Pneumatics Estonia

FINLAND
SMC Pneumatics Finland OY

FRANCE
SMC Pneumatique S.A.

GERMANY
SMC Pneumatik GmbH

GREECE
SMC Hellas EPE

HUNGARY
SMC Hungary Ipari Automatizálási Kft.

IRELAND
SMC Pneumatics (Ireland) Ltd.

ITALY
SMC Italia S.p.A.

KAZAKHSTAN
LLP "SMC Kazakhstan"

LATVIA
SMC Pneumatics Latvia SIA

LITHUANIA
UAB "SMC Pneumatics"

NETHERLANDS
SMC Pneumatics B.V.

NORWAY
SMC Pneumatics Norway AS

POLAND
SMC Industrial Automation Polska Sp. z o.o.

ROMANIA
SMC Romania S.r.l.

RUSSIA
SMC Pneumatik LLC.

SLOVAKIA
SMC Priemysel'ná Automatizácia, Spol s.r.o.

SLOVENIA
SMC Industrijska Avtomatika d.o.o.

SPAIN / PORTUGAL
SMC España, S.A.

SWEDEN
SMC Pneumatics Sweden AB

SWITZERLAND
SMC Pneumatik AG

TURKEY
SMC Pnömatik Sanayi Ticaret ve Servis A.Ş.

UK
SMC Pneumatics (U.K.) Ltd.

ASIA / OCEANIA

AUSTRALIA
SMC Pneumatics (Australia) Pty. Ltd.

CHINA
SMC (China) Co., Ltd.
SMC Pneumatics (Guangzhou) Ltd.

HONG KONG
SMC Pneumatics (Hong kong) Ltd.

INDIA
SMC Pneumatics (India) Pvt. Ltd.

INDONESIA
PT. SMC Pneumatics Indonesia

JAPAN
SMC Corporation

MALAYSIA
SMC Pneumatics (S.E.A.) Sdn. Bhd.

NEW ZEALAND
SMC Pneumatics (N.Z.) Ltd.

PHILIPPINES
Shoketsu SMC Corporation

SINGAPORE
SMC Pneumatics (S.E.A.) Pte. Ltd.

SOUTH KOREA
SMC Pneumatics Korea Co., Ltd.

TAIWAN
SMC Pneumatics (Taiwan) Co., Ltd.

THAILAND
SMC (Thailand) Ltd.

UNITED ARAB EMIRATES
SMC Pneumatics Middle East FZE

VIETNAM
SMC Pneumatics (VN) Co., Ltd

AFRICA

SOUTH AFRICA
SMC Pneumatics (South Africa) Pty Ltd

NORTH, CENTRAL & SOUTH AMERICA

ARGENTINA
SMC Argentina S.A.

BOLIVIA
SMC Pneumatics Bolivia S.R.L.

BRAZIL
SMC Pneumáticos do Brasil Ltda.

CANADA
SMC Pneumatics (Canada) Ltd.

CHILE
SMC Pneumatics (Chile) S.A.

COLOMBIA
SMC Colombia Sucursal de SMC Chile, S.A.

MEXICO
SMC Corporation (Mexico) S.A. de C.V.

PERU
SMC Corporation Peru S.A.C.

USA
SMC Corporation of America

VENEZUELA
SMC Neumatica Venezuela S.A.

U.S. & Canadian Sales Offices

WEST

Austin
Dallas
Los Angeles
Phoenix
Portland
San Jose

CENTRAL

Chicago
Cincinnati
Cleveland
Detroit
Des Moines
Grand Rapids
Indianapolis
Kansas City
Milwaukee
Minneapolis
St. Louis

EAST

Albany
Atlanta
Birmingham
Boston
Charlotte
Knoxville
Nashville
New Jersey
Rochester
Tampa

CANADA

Vancouver
Toronto
Windsor
Montreal

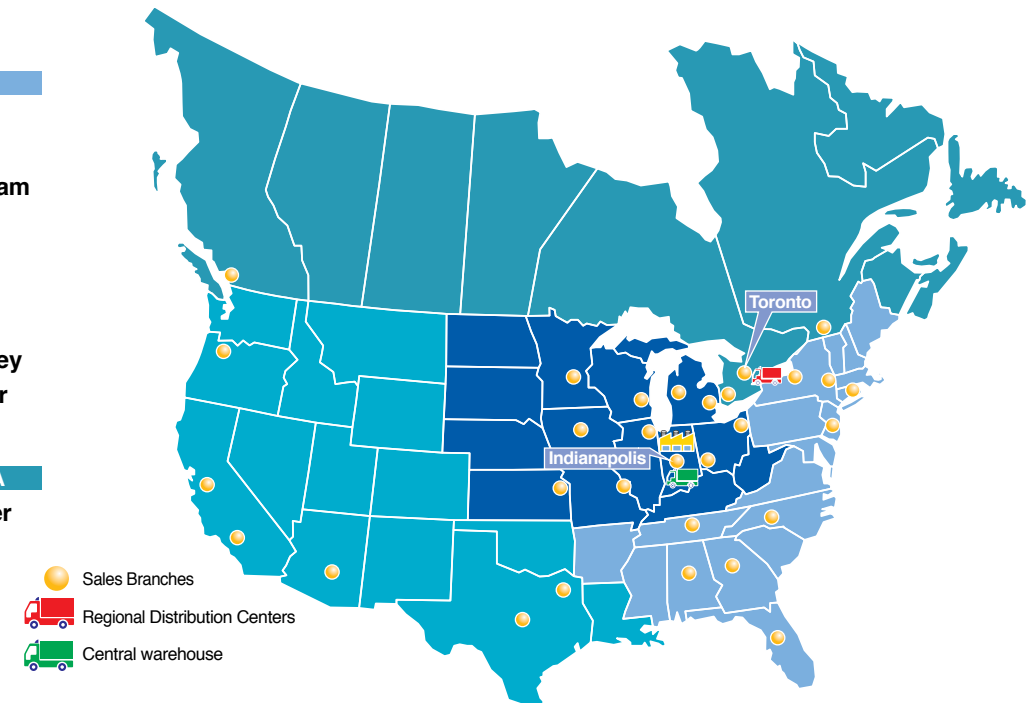

o o o o e c



S E S C S C O C O S C O C O