

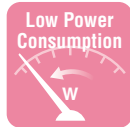

Proposal for Air-saving System

- Contributes to CO₂ emissions reduction -

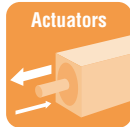

Air Blow

Nozzles for Blowing

Through the use of a smaller diameter nozzle, air consumption can be reduced by **62%**



Pulse Valve

High peak pressure and low air consumption
35% reduction



Impact Blow Gun

Air consumption
85% reduction



Vacuum Equipment

Vacuum Ejector

Due to the energy-saving function, air consumption can be reduced by **93%**



Actuators

Air Saving Speed Controller

By simply mounting on your current air cylinder, air consumption can be reduced by **25%**



Air Cylinder

By selecting an optimal size air cylinder, air consumption can be reduced by **29%**



Booster Regulator

Power consumption
40% reduction



Successful cases of companies that implemented measures for energy saving

Company A performance		Company B performance	
Electricity	3000 kW → 1400 kW	Electricity	10000 kW → 7000 kW
CO ₂	0.9 t reduction/year	CO ₂	1.7 t reduction/year
Cost	\$735,667 reduction/year	Cost	\$1,379,375 reduction/year

We will help you save energy.

- We will help you to improve and standardize your equipment and adopt new equipment.
- We also proactively promote activities through official organizations, such as holding seminars at the Energy Conservation Center.

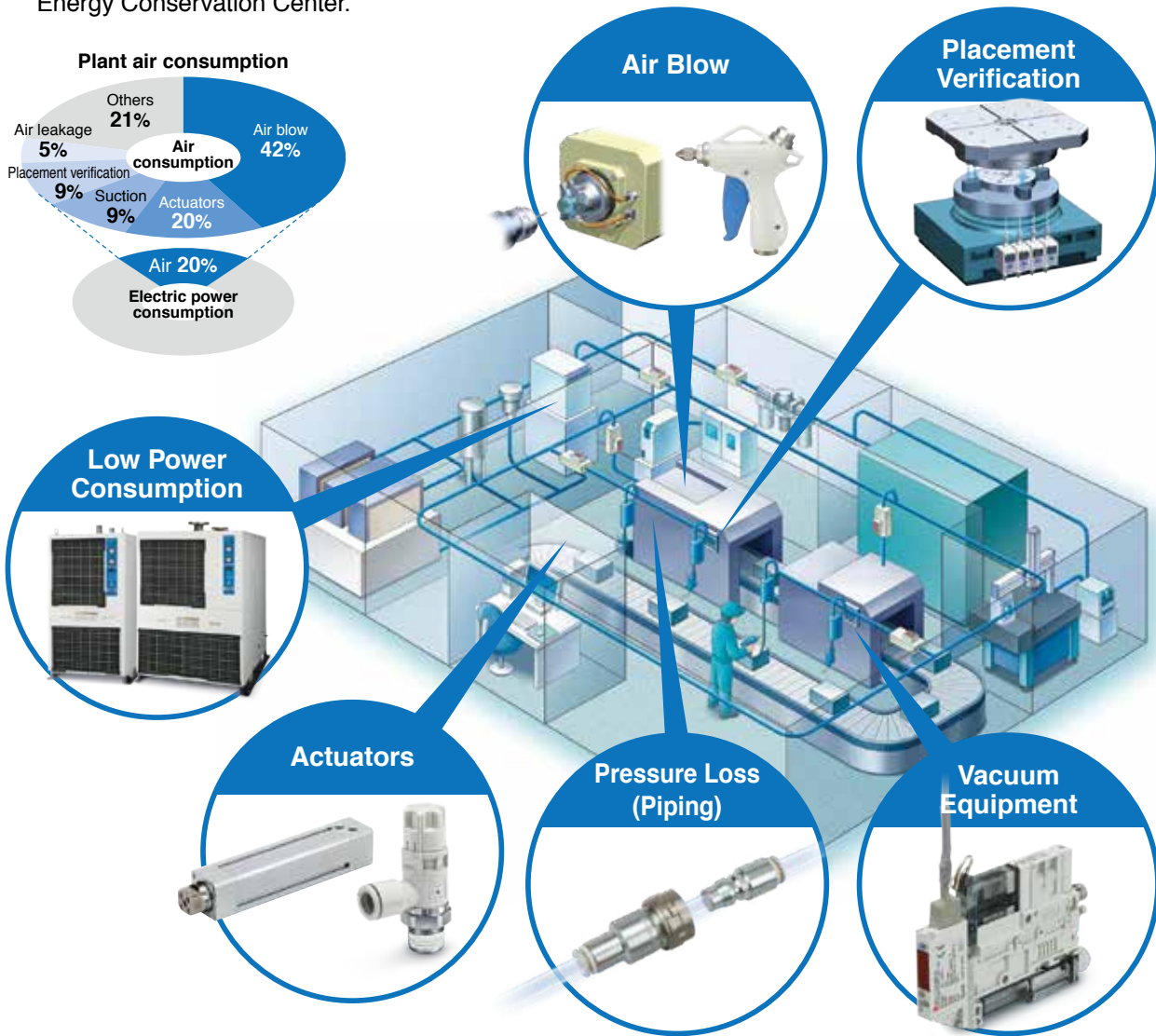

Energy-saving Themes

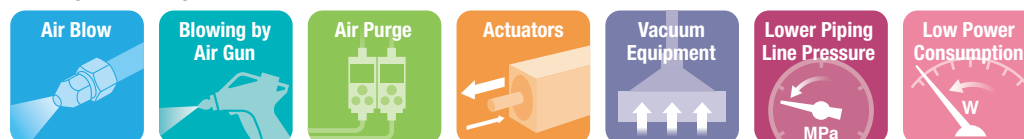

CONTENTS



Air Blow



Nozzles for Blowing <i>KN Series</i>	p. 3
Intermittent Blow Circuit <i>IZE110-X238</i>	p. 4
Pulse Valve Valve for Dust Collector <i>JSXFA Series</i>	p. 5

Blowing by Air Gun



Blow Gun <i>VMG Series</i>	p. 6
----------------------------------	------

Air Purge



Digital Gap Checker <i>ISA3 Series</i>	p. 7
--	------

Actuators



Air Cylinder <i>JMB Series</i>	p. 8
Double Power Cylinder <i>MGZ Series</i>	p. 9
Compact Cylinder with Solenoid Valve <i>CVQ Series</i>	p. 10
Booster Regulator <i>VBA Series</i>	p. 11
Air Saving Speed Controller <i>AS-R/AS-Q Series</i>	p. 12

Vacuum Equipment



Vacuum Ejector <i>ZK2 Series</i>	p. 13
Multistage Ejector <i>ZL112A Series</i>	p. 14

Lower Piping Line Pressure



S Couplers <i>KK130 Series</i>	p. 15
--------------------------------------	-------

Low Power Consumption



3/4/5-Port Solenoid Valve	p. 16
Refrigerated Air Dryer <i>IDF□FS Series</i>	p. 17

Information

Booster Regulator (Size: 10A) <i>VBA-X3145</i>	p. 18
Air Saving Impact Blow Gun <i>IBG1 Series</i>	p. 18

UNIT CONVERSIONS

	unit	conversion	result		unit	conversion	result
length	m	x 3.28	ft	pressure	MPa	x 145	psi
	mm	x 0.04	in		kPa	÷ 6.895	psi
mass	g	x 0.04	oz	temperature	°C	x 1.8 then add 32	°F
volume	cm ³	÷ 16.387	in ³	torque	N·m	x 0.738	ft·lb
	L	x 61.024	in ³	force	N	÷ 4.448	lbf
speed	mm/s	÷ 25.4	in/s	flow	L/min	÷ 28.317	cfm

Nozzles for Blowing *KN Series*



Air consumption

**62%
reduction**

Air consumption can be reduced through the use of a smaller diameter nozzle.

Blow circuit that facilitates effective pressure use

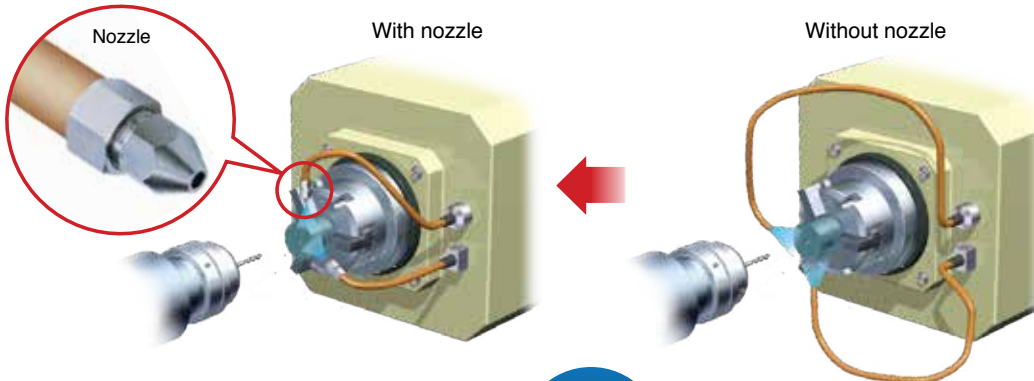
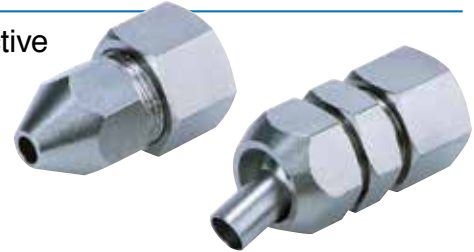

Energy-saving Model

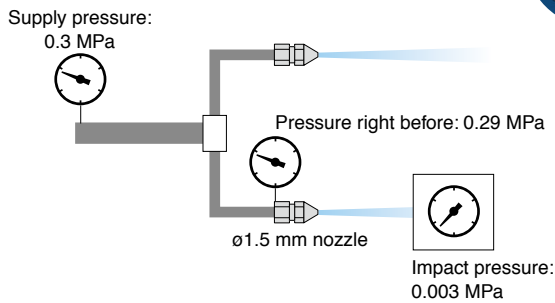

Collective piping: TU0805, 2 m
Intermediate and end piping:
TU0604, 0.5 m each
Distance: 100 mm

Air consumption per nozzle:
74 L/min (ANR)

Blow time: 2 sec.
Annual operating cycles:
90000

4464 m³/year (ANR)
(\$62 /year)
(\$98/year reduction)

Effects of Energy Saving

Existing Model

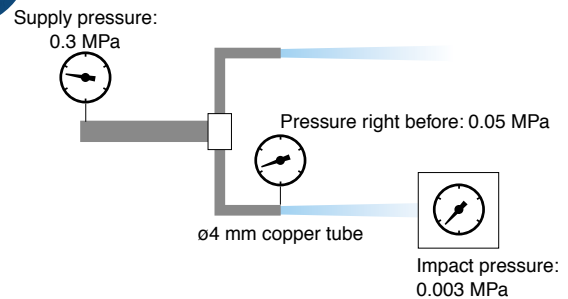

Collective piping: TU0805, 2 m
Intermediate and end piping:
TU0604, 0.5 m each
Distance: 100 mm

Air consumption per nozzle:
192 L/min (ANR)

Blow time: 2 sec.
Annual operating cycles:
90000

11520 m³/year (ANR)
(\$159 /year)

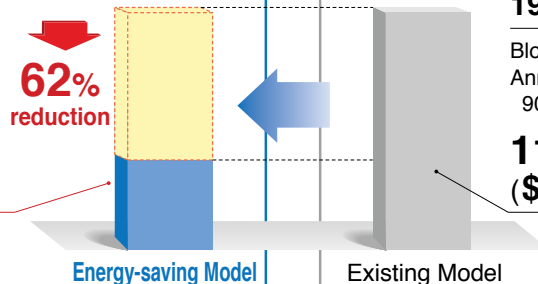

Corresponding value: Air unit \$0.01/m³ (ANR)

Intermittent Blow Circuit IZE110-X238

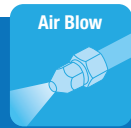

Air consumption
50% reduction

By using intermittent blow based on an intermittent control timer, air consumption can be reduced by **50%**.



Intermittent Blow Circuit

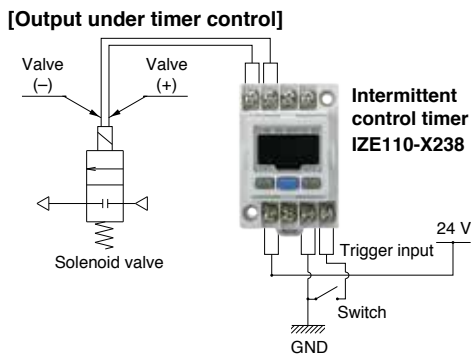

Continuous Blow Circuit

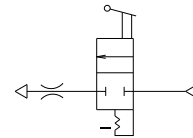

Energy-saving Circuit

The duty ratio can be freely adjusted. By setting the duty ratio to one that has the same blow effectiveness, air consumption can be reduced.

Example:

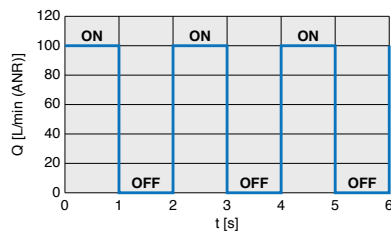

Existing Circuit

The duty ratio is equivalent to 100%.

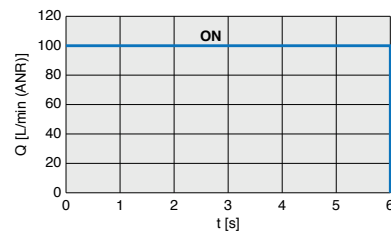

Intermittent Blow Circuit

Pressure right before: 0.2 MPa
Blow time: 10 s
(Frequency: 12 times/h)
One blow operation:
ON for 1 s, OFF for 1 s;
Repeated a total of 5 times
Working hours: 10 h/day
(250 days/year)
Nozzle diameter: 1 mm

318.2 m³/year (ANR)
(\$5/year)
(\$5/year reduction)

Energy-saving Circuit

Effects of Energy Saving

50% reduction

Existing Circuit

Pressure right before: 0.2 MPa
Blow time: 10 s
(Frequency: 12 times/h)
Working hours:
10 h/day (250 days/year)
Nozzle diameter: 1 mm

636.3 m³/year (ANR)
(\$9/year)

Existing Circuit

Corresponding value: Air unit \$0.01/m³ (ANR)

Pulse Valve Valve for Dust Collector JSXFA Series

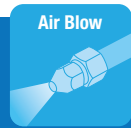

Peak pressure

15%*
increase

Air consumption

35%*
reduction

High peak pressure and low air consumption

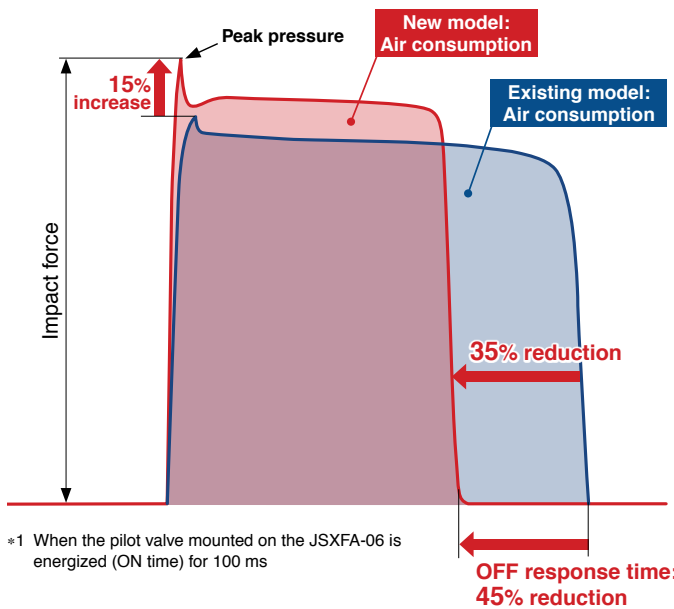

*1 When the pilot valve mounted on the JSXFA-06 is energized (ON time) for 100 ms

Energy-saving Model	Existing Model
<ul style="list-style-type: none"> ·Optimized internal geometry ·Improved response 	<ul style="list-style-type: none"> ·Flow path construction with a large pressure loss ·Long response time
<p>Injection quantity per cycle: 57 L/cycle (ANR)</p>	<p>Injection quantity per cycle: 88 L/cycle (ANR)</p>
<p>Pressure: 0.9 MPa Energizing time: 100 ms Annual operating cycles: 240000</p>	<p>Pressure: 0.9 MPa Energizing time: 100 ms Annual operating cycles: 240000</p>
<p>13680 m³/year (ANR) (\$189 /year) (\$103/year reduction)</p>	<p>21120 m³/year (ANR) (\$292 /year)</p>
<p>35% reduction</p> <p>Energy-saving Model</p>	<p>Existing Model</p>

Effects of Energy Saving

Corresponding value: Air unit \$0.01/m³ (ANR)

Blow Gun VMG Series

Blowing by Air Gun



Power consumption

20% reduction

Power consumption can be reduced by 20% with the SMC blow gun + S coupler + coil tube combination.

* 10% reduction with only the blow gun (VMG)

Pressure loss of **1% or less**



Example of Improvement

Review the blow work and change to the SMC blow gun, S coupler, and coil tube combination to create a larger effective area.

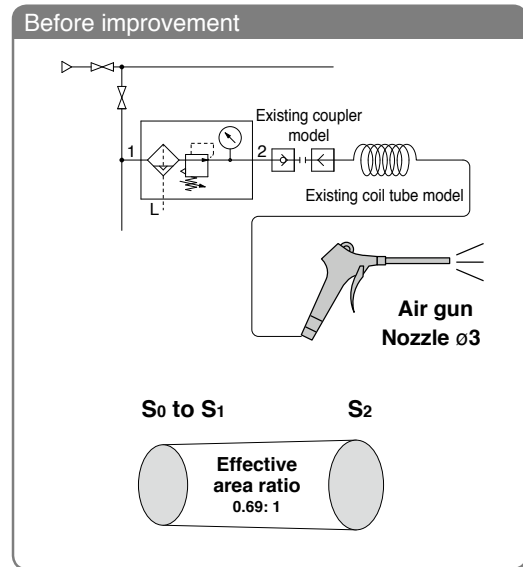
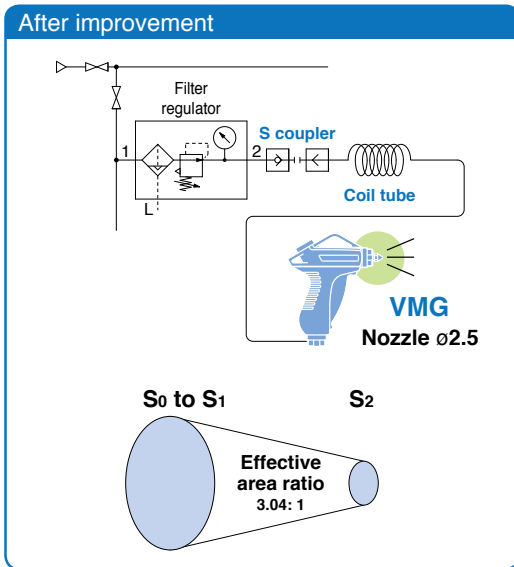

Energy-saving Model

Impact pressure: 0.011 MPa (Distance: 100 mm)
Blow time: 10 s (Frequency: 12 times/h)
Working hours: 10 h/day (250 days/year)
Total working hours: 8300 h
Compressor pressure: **0.5 MPa**
Air consumption: **257 L/min (ANR)**

Power consumption by compressor: **20% reduction**
1.25 kW
(\$1455/year)
(\$361/year reduction)

Energy-saving Model

Effects of Energy Saving

Existing Model

Impact pressure: 0.011 MPa (Distance: 100 mm)
Blow time: 10 s (Frequency: 12 times/h)
Working hours: 10 h/day (250 days/year)
Total working hours: 8300 h
Compressor pressure: 0.6 MPa
Air consumption: 287 L/min (ANR)

Power consumption by compressor:
1.56 kW
(\$1816/year)

Existing Model

Corresponding value: Electricity unit \$0.14/kWh

Digital Gap Checker *ISA3 Series*

Air Purge



Air consumption

**60%
reduction**

Air consumption when a workpiece is seated is now **0 L/min** due to the new detection principle.



Comparison of detection circuit

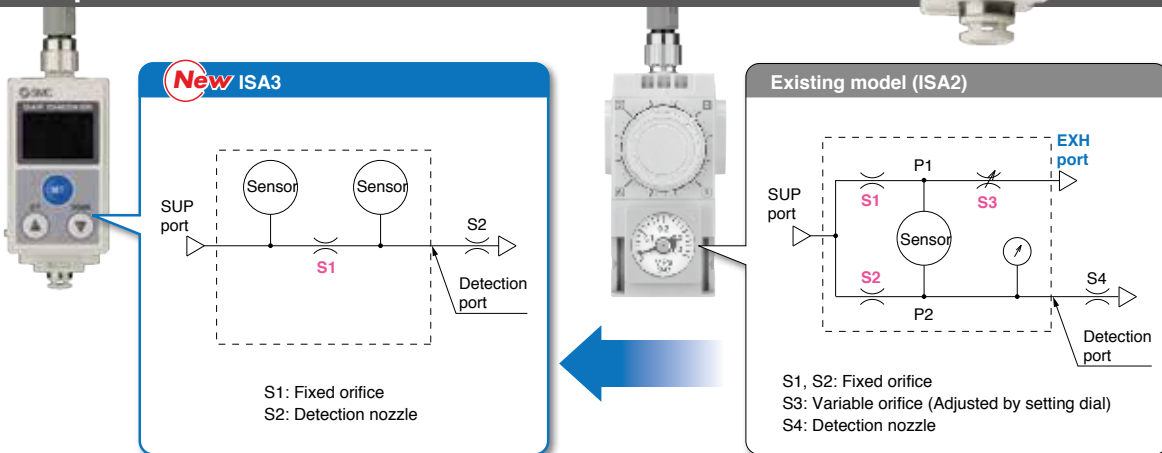

Due to the new detection principle, the need for air to be exhausted from the product has been eliminated. This makes the flow consumption 0 L/min when a workpiece is seated.

The result is a great reduction in air consumption compared with the existing model.

* Conditions: Unseated for 5 seconds and seated for 20 seconds (For the G type)

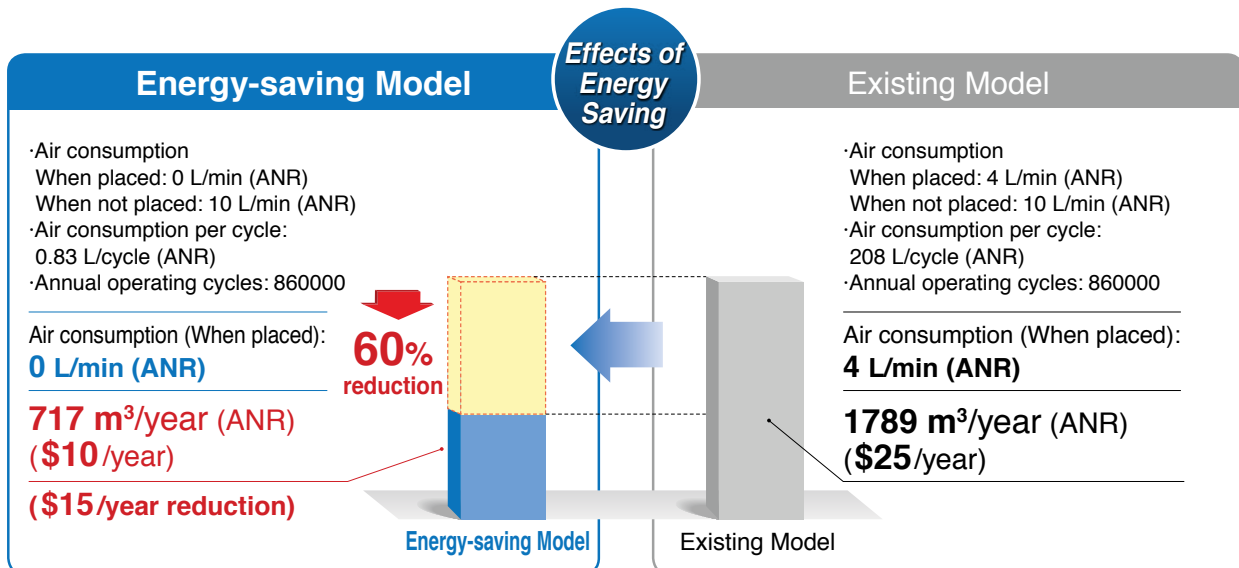

Corresponding value: Air unit \$0.01/m³ (ANR)

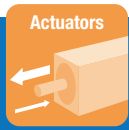

Air Cylinder JMB Series

Air consumption
29% reduction

Air consumption can be reduced by selecting an optimal size air cylinder.



Intermediary Bore Sizes

Air consumption can be reduced by up to **29%**

Bore size (mm)	ø40	ø45	ø50	ø56	ø63	ø67	ø80	ø85	ø100
Air consumption L/min (ANR)	1.4	1.8	2.2	2.8	3.6	4.1	5.8	6.6	9.1

Conditions/Supply pressure: 0.5 MPa
Load factor: 50%, At 100 mm stroke

18% reduction **22% reduction** **29% reduction** **27% reduction**

Example Bore size for 85 kg workpieces

Conditions/Supply pressure: 0.5 MPa, Load factor: 50%

Bore size (mm)	Theoretical output (N)	Output for load factor of 50% (kg)	Judgment
ø63	1559	79.5	Not acceptable (Insufficient)
ø80	2513	128.2	Acceptable (Excessive)

When intermediary bore size ø67 is used

ø67	1763	89.9	OK
-----	------	------	----

Existing size: ø80
↑
Could be switched to intermediary bore size ø67

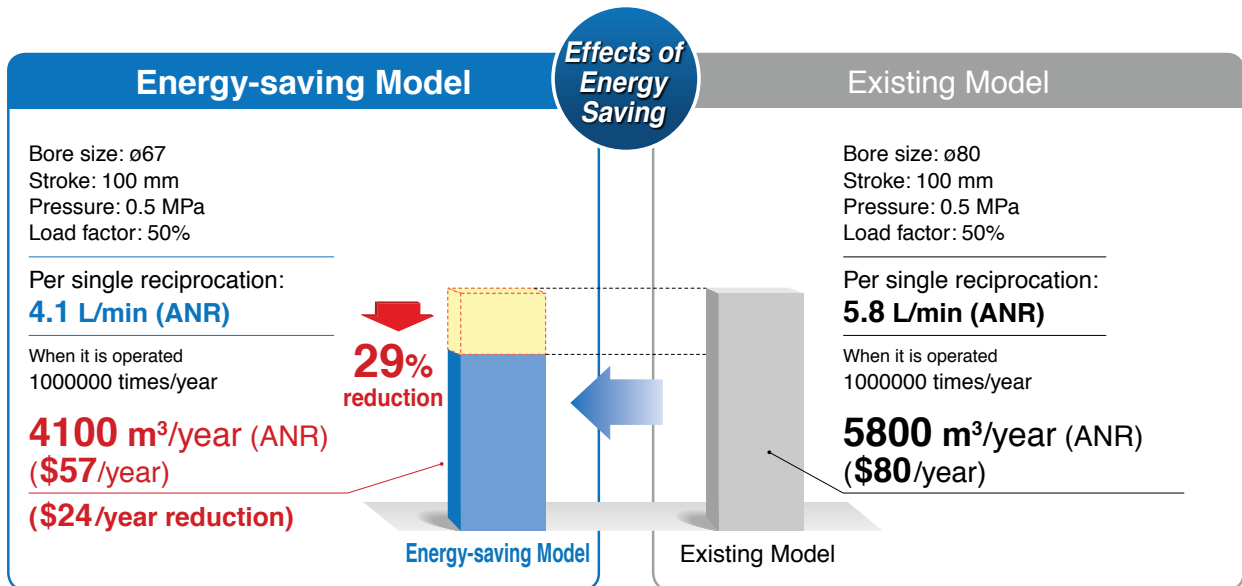

Corresponding value: Air unit \$0.01/m³ (ANR)

Double Power Cylinder *MGZ Series*

Actuators



Air consumption

**14%
reduction**

Air consumption can be reduced by **14%** due to the reduced cylinder size.

It is possible to reduce air consumption in the retracting direction, compared with a standard cylinder with equivalent output in the extending direction, due to the doubled piston area in the extending direction.



Double extension output power!

SMC's unique cylinder construction doubles the piston area in the extending direction. This is an ideal air cylinder for lifting and press applications.

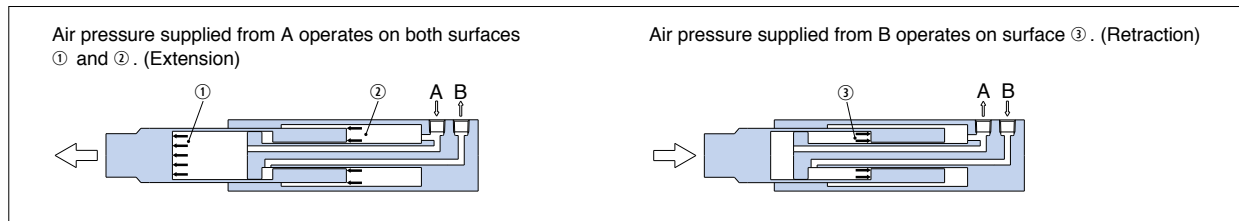

ø63

Piston area
Extension: 5945 mm²
Retraction: 2313 mm²

Increased energy saving and space saving
Reduced cylinder size

Size reduction
ø63 ← ø80

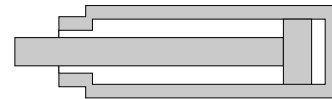

ø80

Piston area
Extension: 5030 mm²
Retraction: 4540 mm²

Energy-saving Model

Bore size: **ø63**
Stroke: 200 mm
Pressure on the extension side: 0.5 MPa

Theoretical output (Extension side): 2973 N
Per single reciprocation:
9.9 L (ANR)

When it is operated
900000 times/year

8910 m³/year (ANR)
(\$123/year)
(\$20/year reduction)

**14%
reduction**

Energy-saving Model

Effects of
Energy
Saving

Existing Model

Bore size: ø80
Stroke: 200 mm
Pressure: 0.5 MPa

Theoretical output (Extension side): 2520 N
Per single reciprocation:
11.5 L (ANR)

When it is operated
900000 times/year

10350 m³/year (ANR)
(\$143/year)

Existing Model

Corresponding value: Air unit \$0.01/m³ (ANR)

Compact Cylinder with Solenoid Valve *CVQ Series*

Actuators



Air consumption

37%
reduction

Energy Saving

Air consumption between the valve and cylinder can be reduced by approximately **37%**.



Valve and compact cylinder integrated for compactness

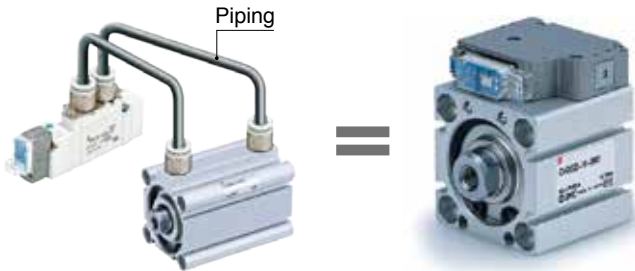

Energy-saving Model



Effects of
Energy
Saving

Existing Model



CVQ

Bore size: $\phi 32$
Stroke: 50 mm
No piping between the valve and the cylinder
Supply pressure: 0.5 MPa

Per single reciprocation:

0.42 L (ANR)

When it is operated
900000 times/year

380 m³/year (ANR)
(\$6/year)

(\$3/year reduction)

37%
reduction

Energy-saving Model

CQ2

Bore size: $\phi 32$
Stroke: 50 mm
Piping bore: 4 mm
Piping length: 2 m (Between the valve and the cylinder)
Supply pressure: 0.5 MPa

Per single reciprocation:

0.67 L (ANR)

When it is operated
900000 times/year

606 m³/year (ANR)
(\$8/year)

Existing Model

Corresponding value: Air unit \$0.01/m³ (ANR)

Booster Regulator VBA Series

Air consumption
33% reduction

Air consumption can be reduced by **33%** due to the optimization of the booster circuit.



Boost an insufficiently powered portion with a booster regulator

- Optimized booster circuit: Now with a space-saving booster circuit

Example of a one-side booster circuit (Boosting pressure on the operating stroke only)

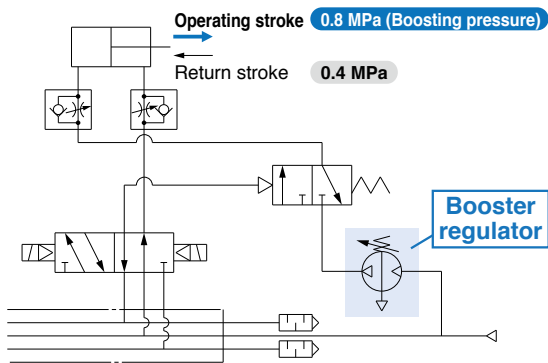

Example of a two-side booster circuit

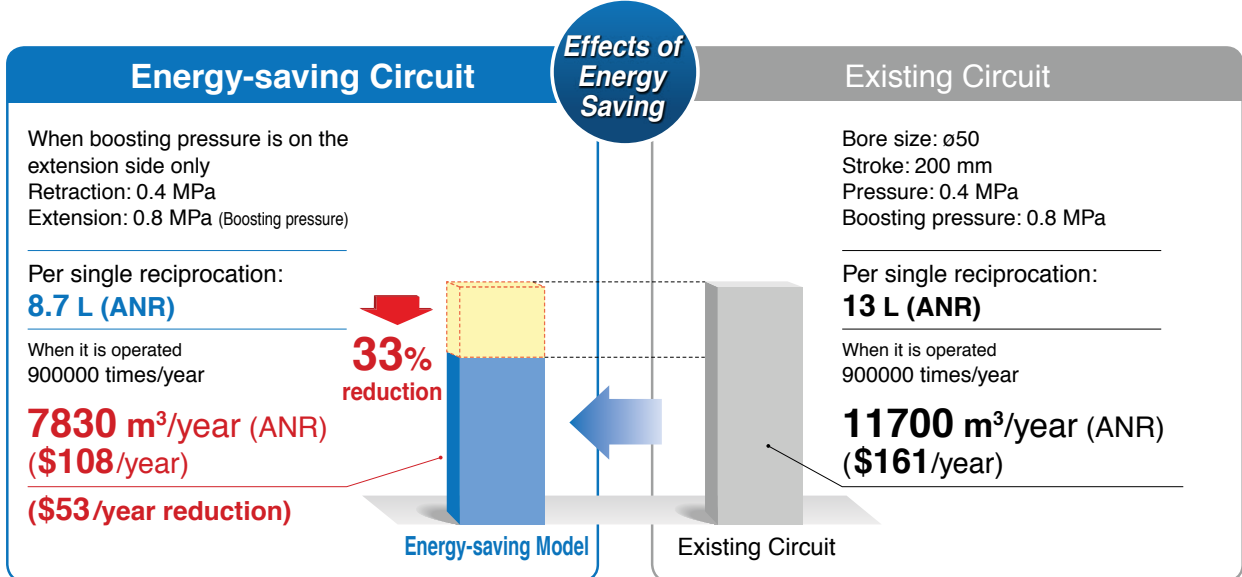
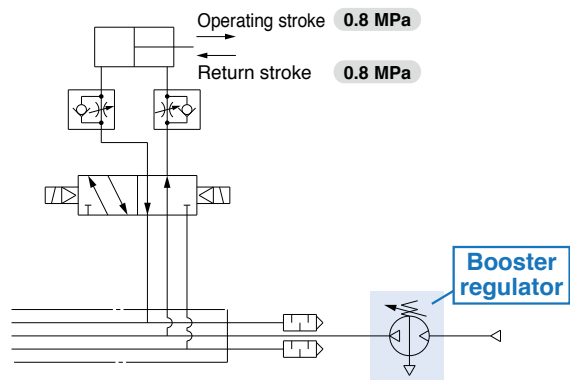

Corresponding value: Air unit \$0.01/m³ (ANR)

Air Saving Speed Controller AS-R/AS-Q Series

Actuators



Air consumption

**25%
reduction**

Reduce air consumption just by mounting to your current air cylinder!

Mounting and operation are the same as a regular speed controller.



With pressure-reduction function
AS-R Series

By reducing the pressure on the return stroke to 0.2 MPa, air consumption can be reduced.

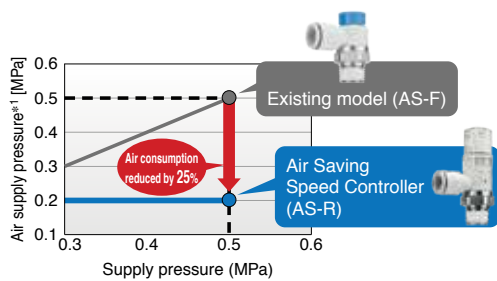

*1 Cylinder pressure on the return stroke side
* The air consumption reduction rate indicates the rate for one cycle of the cylinder.

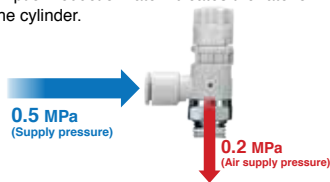

When it is not necessary to apply force at the end of the working stroke, by using a lifter, pusher, etc.

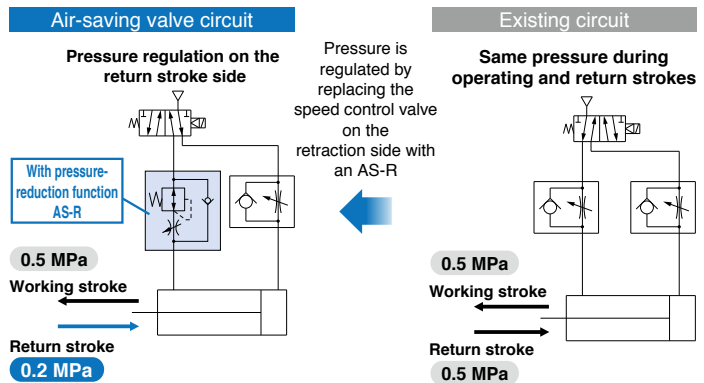

Energy-saving Model

Bore size: $\phi 50$
Stroke: 200 mm
Pressure on the extension side: 0.5 MPa
Pressure on the retraction side: 0.2 MPa

Per single reciprocation:
3.3 L/min (ANR)

When it is operated
900000 times/year

3011 m³/year (ANR)
(\$42/year)

(\$12/year reduction)

**25%
reduction**

Energy-saving Model

Effects of Energy Saving

Existing Model

Bore size: $\phi 50$
Stroke: 200 mm
Pressure: 0.5 MPa

Per single reciprocation:
4.3 L/min (ANR)

When it is operated
900000 times/year

3902 m³/year (ANR)
(\$54/year)

Existing Model

Corresponding value: Air unit \$0.01/m³(ANR)

Vacuum Ejector ZK2 Series



Air consumption

**93%
reduction***1

*1 Based on SMC's measuring conditions

Energy-saving Ejector

The digital pressure switch for vacuum with energy-saving function cuts supply air when the pressure reaches the desired vacuum.

Digital pressure switch for vacuum with energy-saving function



The digital pressure switch **with energy-saving function** can reduce air consumption by **90%***2. *2 Based on SMC's measuring conditions

While the suction signal is ON, the ON/OFF operation of the supply valve is also performed automatically within the set value.

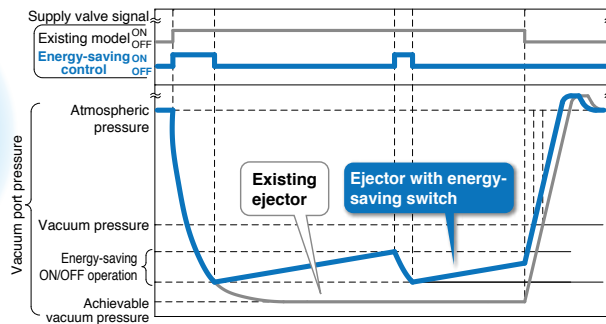
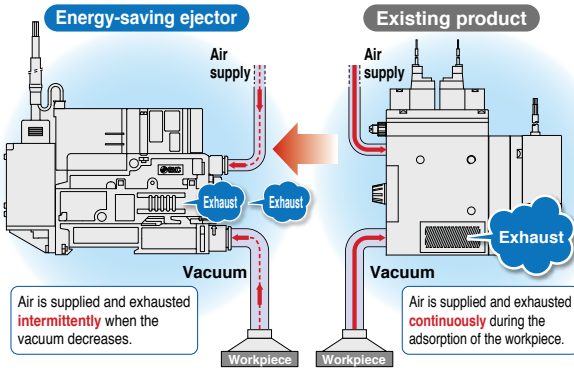

Energy-saving Model

- Air consumption: 58 L/min (ANR)
- Vacuum suction flow rate: 61 L/min (ANR)
- Vacuum generation time: 0.6 s/cycle (Vacuum is continuously generated and air is consumed for 6 s (1 cycle))
- Annual operating cycles: 1100000 (450 cycles/h, 10 h/day, 250 days/year)

Air consumption (When placed):
58 L/min (ANR)
638 m³/year (ANR)
(\$9/year)
(\$120/year reduction)

**93%
reduction**

Energy-saving Model

Effects of Energy Saving

Existing Model

- Air consumption: 85 L/min (ANR)
- Vacuum suction flow rate: 44 L/min (ANR)
- Vacuum generation time: 6 s/cycle (Vacuum is continuously generated and air is consumed for 6 s (1 cycle))
- Annual operating cycles: 1100000 (450 cycles/h, 10 h/day, 250 days/year)

Air consumption (When placed):
85 L/min (ANR)
9350 m³/year (ANR)
(\$129/year)

Existing Model

Corresponding value: Air unit \$0.01/m³ (ANR)

Multistage Ejector ZL112A Series



Air consumption

10% reduction

Air consumption can be reduced by **10%** due to the optimization of the diffuser flow path.

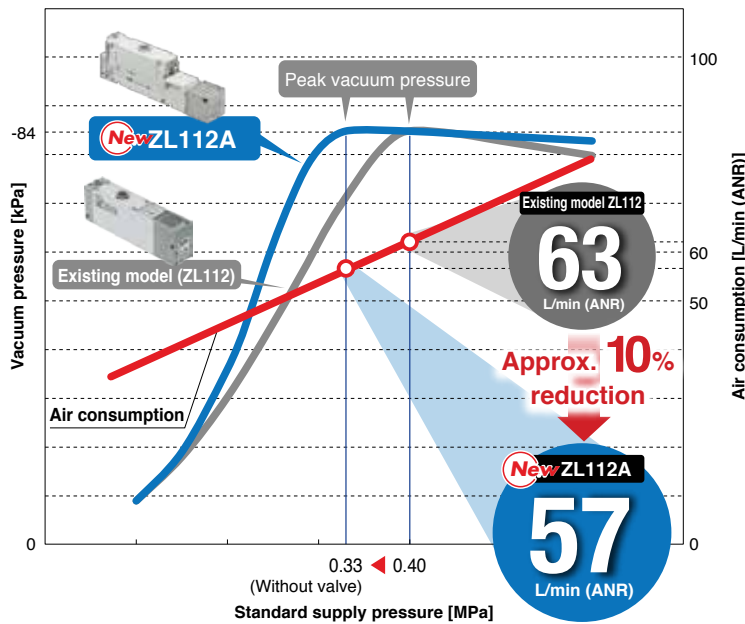

3-stage diffuser construction

Suction flow rate increased by **250%**
(Versus $\phi 1.3$, 1-stage model)

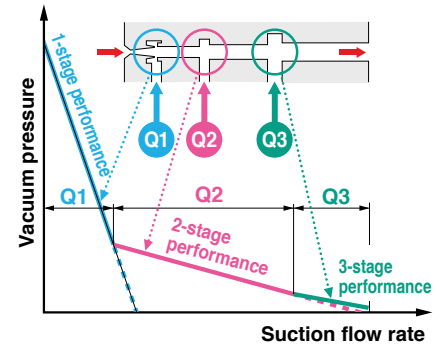

Energy-saving Model

Standard supply pressure: 0.33 MPa (Without valve)
Maximum vacuum pressure: -84 kPa
Maximum suction flow rate: 100 L/min (ANR)
Air consumption: 57 L/min (ANR)

When work is carried out for 2500 hours per year, and 30 minutes per hour

4275 m³/year (ANR)
(\$59 /year)

(\$6 /year reduction)

10% reduction

Energy-saving Model

Effects of Energy Saving

Existing Model

Standard supply pressure: 0.4 MPa
Maximum vacuum pressure: -84 kPa
Maximum suction flow rate: 100 L/min (ANR)
Air consumption: 63 L/min (ANR)

When work is carried out for 2500 hours per year, and 30 minutes per hour

4725 m³/year (ANR)
(\$65 /year)

Existing Model

Corresponding value: Air unit \$0.01/m³ (ANR)

S Couplers *KK130 Series*

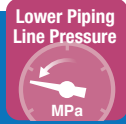

Pressure loss

7%
reduction

The built-in valve is of a special shape, resulting in reduced pressure loss.

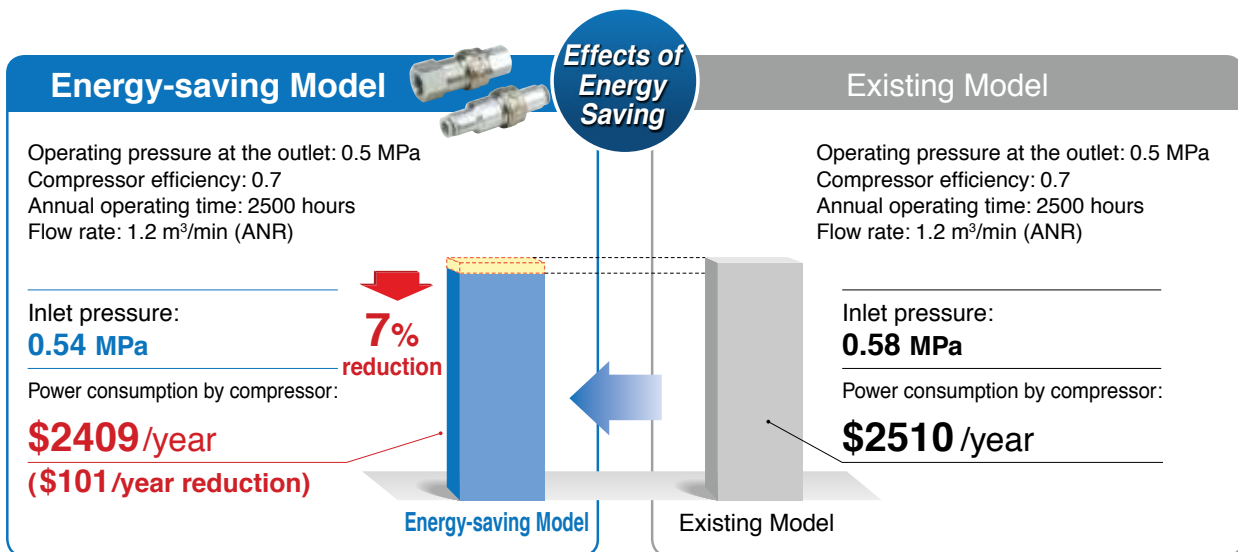
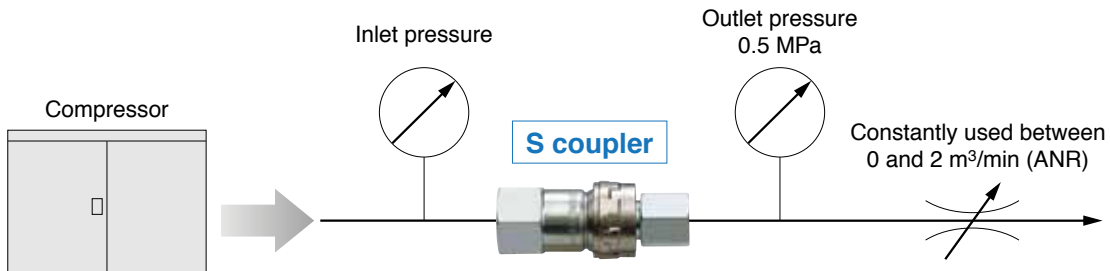

Corresponding value: Electricity unit \$0.14/kWh

3/4/5-Port Solenoid Valve

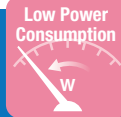

Power consumption

75%
reduction

The power-saving circuit can reduce the consumption of electric power when the device is energized.

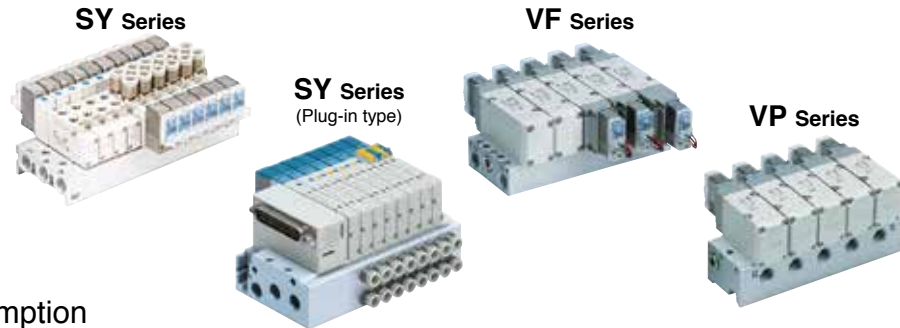

- Reduces power consumption when energized

Power consumption can be reduced by approx. 1/4 by reducing the wattage required to hold the valve in an energized state. (Effective energizing time is over 62 ms*1 at 24 VDC.) Refer to the electrical power waveform as shown below.

Electrical power waveform with power-saving circuit

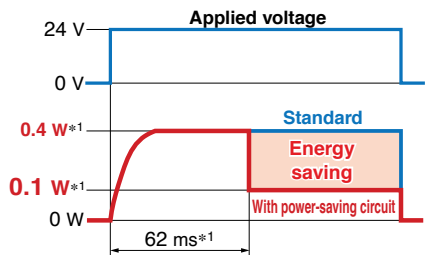

*1 SY/SYJ series

Low Power Consumption Valve

Energy-saving Product

Type	Model	Power consumption W*2	
		Standard	With power-saving circuit
4/5-port	SJ2000	0.55	0.23
	SJ3000	0.4	0.15
	New SY3000/5000/7000	0.4	0.15
	SY3000/5000/7000/9000	0.4	0.1
	SYJ3000/5000/7000	0.4	0.1
	VF1000/3000/5000	1.55	0.55
3-port	SYJ300/500/700	0.4	0.1
	VP300/500/700	1.55	0.55
	V100	0.4	0.1

*2 With DC light

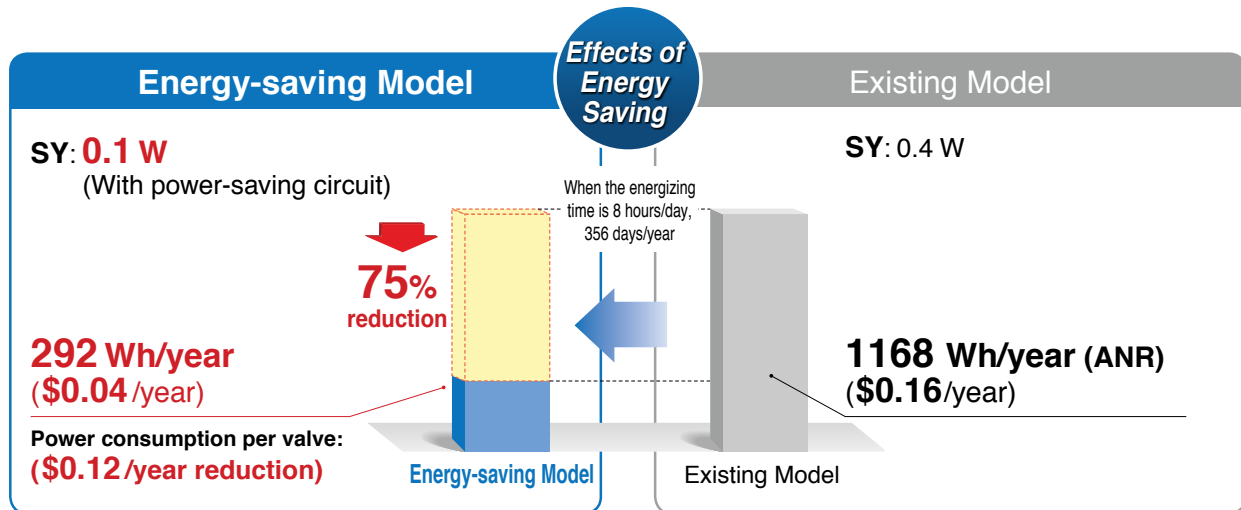

Corresponding value: Electricity unit \$0.14/kWh

Refrigerated Air Dryer *IDF□FS Series*



Double energy-saving function series



Power consumption

76%
reduction

The addition of a second re-heater + digital scroll results in high energy savings.

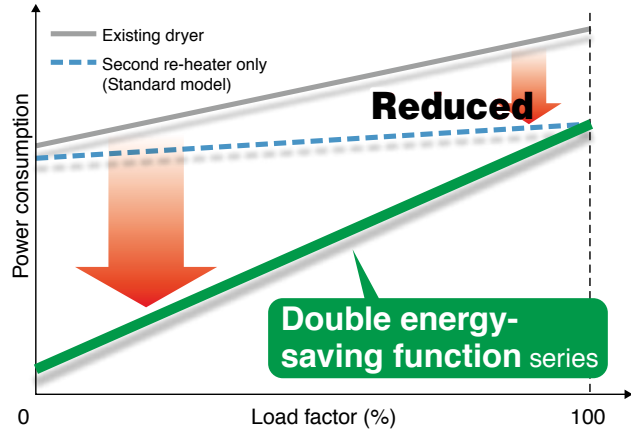

Energy-saving design

Up to a **76%** (1 kW)*1 reduction

- *1 Operating conditions: The IDF125FS in energy-saving operation mode
- Ambient temperature 32°C ● Inlet air temperature 40°C
- Inlet air pressure 0.7 MPa ● Air flow rate = Rated flow x 0.4
- Power supply frequency 60 Hz ● Power supply voltage 200 V ● Set dew point = 30°C



Example 1 year (Spring to Winter) Power consumption

Reduced



Compared with the standard model (constant compressor operation), the

Double energy-saving function series

*1 The IDF125FS was used for this example.

can reduce power consumption by 43%!



* [Trial calculation conditions] Days of operation per year = 240 days (60 days each in spring, summer, autumn, and winter), Operating hours per day = 12 hours
For details about the dryer operating conditions for each season, refer to the **Web Catalog** (IDF□FS series).

Booster Regulator (Size: 10A) *VBA-X3145*

Air consumption

40% reduction^{*1}

*1 Based on SMC's measuring conditions

- 3 piston construction
- The drive chamber on one side can be operated by the exhaust return circuit.



Operation noise: **65 dB (A)**^{*2}

*2 Based on SMC's measuring conditions

15 dB (A) reduction compared with the existing model (VBA series)

- Exhaust noise: Reduced noise due to exhaust of reused low-pressure air
- Metal noise: Reduced noise due to the adoption of a construction in which the internal switching part doesn't come into contact with any metal parts

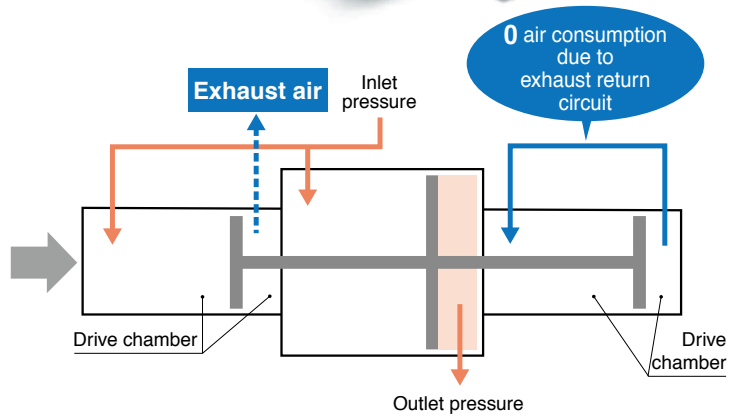

* Please contact your local sales representative for more details.

Air Saving Impact Blow Gun *IBG1 Series*

Increased impact force due to higher peak pressure
Drastic reduction in air consumption and labor time

High peak pressure

3 times or more^{*1}
(Compared with the existing model)

Air consumption

85% reduction^{*2}

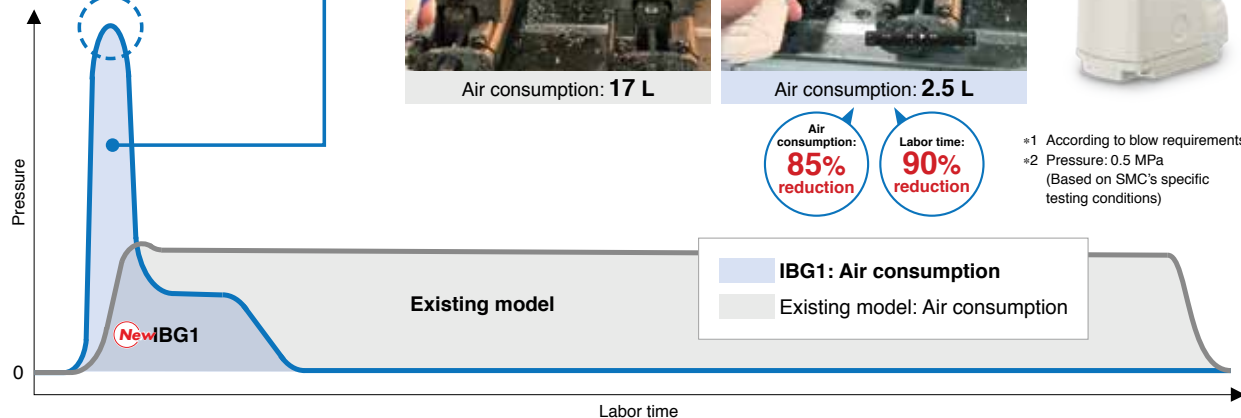

Air consumption: **85% reduction**
Labor time: **90% reduction**

*1 According to blow requirements
*2 Pressure: 0.5 MPa
(Based on SMC's specific testing conditions)

* Please contact your local sales representative for more details.

Global Manufacturing, Distribution and Service Network

Worldwide Subsidiaries

EUROPE

AUSTRIA
SMC Pneumatik GmbH (Austria)

BELGIUM
SMC Pneumatics N.V./S.A.

BULGARIA
SMC Industrial Automation Bulgaria EOOD

CROATIA
SMC Industrijska Automatika d.o.o.

CZECH REPUBLIC
SMC Industrial Automation CZ s.r.o.

DENMARK
SMC Pneumatik A/S

ESTONIA
SMC Pneumatics Estonia

FINLAND
SMC Pneumatics Finland OY

FRANCE
SMC Pneumatique S.A.

GERMANY
SMC Pneumatik GmbH

GREECE
SMC Hellas EPE

HUNGARY
SMC Hungary Ipari Automatizálási Kft.

IRELAND
SMC Pneumatics (Ireland) Ltd.

ITALY
SMC Italia S.p.A.

KAZAKHSTAN
LLP "SMC Kazakhstan"

LATVIA
SMC Pneumatics Latvia SIA

LITHUANIA
UAB "SMC Pneumatics"

NETHERLANDS
SMC Pneumatics B.V.

NORWAY
SMC Pneumatics Norway AS

POLAND
SMC Industrial Automation Polska Sp. z o.o.

ROMANIA
SMC Romania S.r.l.

RUSSIA
SMC Pneumatik LLC.

SLOVAKIA
SMC Priemysel'ná Automatizácia, Spol s.r.o.

SLOVENIA
SMC Industrijska Avtomatika d.o.o.

SPAIN / PORTUGAL
SMC España, S.A.

SWEDEN
SMC Pneumatics Sweden AB

SWITZERLAND
SMC Pneumatik AG

TURKEY
SMC Pnömatik Sanayi Ticaret ve Servis A.Ş.

UK
SMC Pneumatics (U.K.) Ltd.

ASIA / OCEANIA

AUSTRALIA
SMC Pneumatics (Australia) Pty. Ltd.

CHINA
SMC (China) Co., Ltd.
SMC Pneumatics (Guangzhou) Ltd.

HONG KONG
SMC Pneumatics (Hong kong) Ltd.

INDIA
SMC Pneumatics (India) Pvt. Ltd.

INDONESIA
PT. SMC Pneumatics Indonesia

JAPAN
SMC Corporation

MALAYSIA
SMC Pneumatics (S.E.A.) Sdn. Bhd.

NEW ZEALAND
SMC Pneumatics (N.Z.) Ltd.

PHILIPPINES
Shoketsu SMC Corporation

SINGAPORE
SMC Pneumatics (S.E.A.) Pte. Ltd.

SOUTH KOREA
SMC Pneumatics Korea Co., Ltd.

TAIWAN
SMC Pneumatics (Taiwan) Co., Ltd.

THAILAND
SMC (Thailand) Ltd.

UNITED ARAB EMIRATES
SMC Pneumatics Middle East FZE

VIETNAM
SMC Pneumatics (VN) Co., Ltd

AFRICA

SOUTH AFRICA
SMC Pneumatics (South Africa) Pty Ltd

NORTH, CENTRAL & SOUTH AMERICA

ARGENTINA
SMC Argentina S.A.

BOLIVIA
SMC Pneumatics Bolivia S.R.L.

BRAZIL
SMC Pneumáticos do Brasil Ltda.

CANADA
SMC Pneumatics (Canada) Ltd.

CHILE
SMC Pneumatics (Chile) S.A.

COLOMBIA
SMC Colombia Sucursal de SMC Chile, S.A.

MEXICO
SMC Corporation (Mexico) S.A. de C.V.

PERU
SMC Corporation Peru S.A.C.

USA
SMC Corporation of America

VENEZUELA
SMC Neumatica Venezuela S.A.

U.S. & Canadian Sales Offices

WEST

Austin
Dallas
Los Angeles
Phoenix
Portland
San Jose

CENTRAL

Chicago
Cincinnati
Cleveland
Detroit
Des Moines
Grand Rapids
Indianapolis
Kansas City
Milwaukee
Minneapolis
St. Louis

EAST

Albany
Atlanta
Birmingham
Boston
Charlotte
Knoxville
Nashville
New Jersey
Rochester
Tampa

CANADA

Vancouver
Toronto
Windsor
Montreal

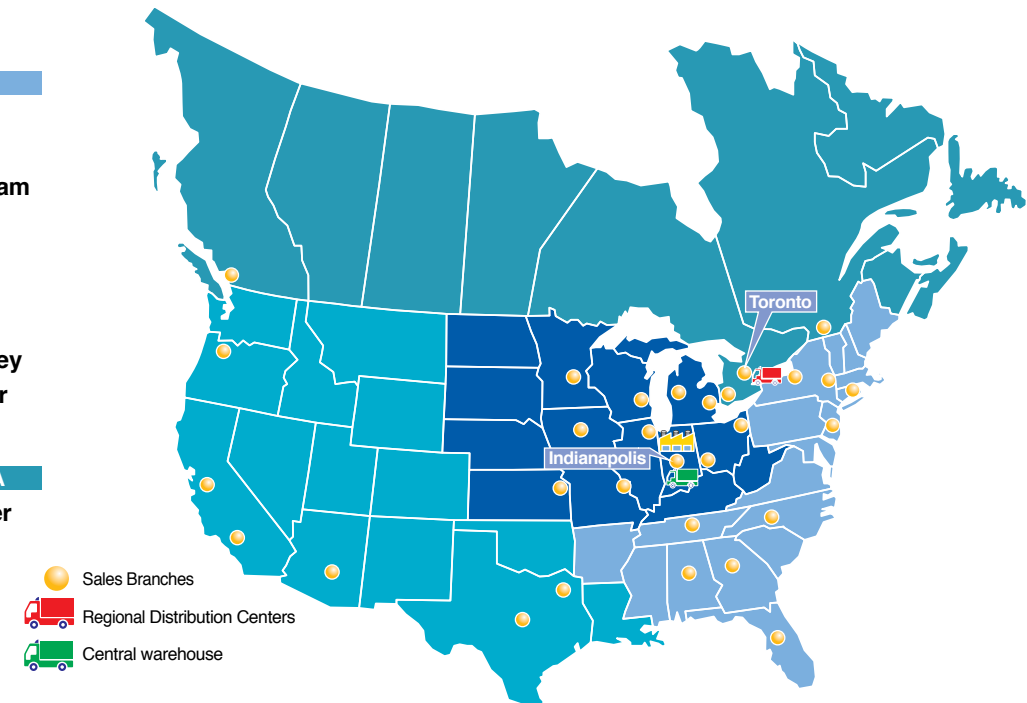

o o o o e c



S E S C S C O S C O C O