

Digital Flow Switch for Water

Lightweight
**Max. 53%^{*1}
reduction**

Rated flow range [L/min]	Weight [g]	
	New PF3W7-Z	PF3W7
0.5 to 4	166 ← 42% reduction	285
2 to 16	184 ← 45% reduction	335
5 to 40	248 ← 53% reduction	530
10 to 100	748 ← 13% reduction	860

*1 40 L/min, With temperature sensor



IO-Link Compatible

- Process data size: 6-byte input
- Various types of diagnostic tests can be performed using service data.

PF3W7-L Series p.9
Diagnostic contents

Over current error, Above the rated flow/temperature range, Accumulated flow error, Below the rated temperature range, Internal product malfunction, Temperature sensor failure

Rated flow range

· 0.5 to 4 · 2 to 16 · 5 to 40 · 10 to 100 · 50 to 250 L/min

Variations

Type	Rated flow range [L/min]	Flow adjustment valve/Temperature sensor				Port size Rc, NPT, G	Applicable fluid
		None	Flow adjustment valve	Temperature sensor	Flow adjustment valve + Temperature sensor		
 Integrated	0.5 to 4	●	●	●	●	3/8	Water, Ethylene glycol aqueous solution
	2 to 16	●	●	●	●	3/8, 1/2	
	5 to 40	●	●	●	●	1/2, 3/4	
	10 to 100	●	—	●	—	3/4, 1	
 Remote sensor							

PF3W-Z/L Series

 NC463A
 (CAT.ES100-133A)

3-color/2-screen display

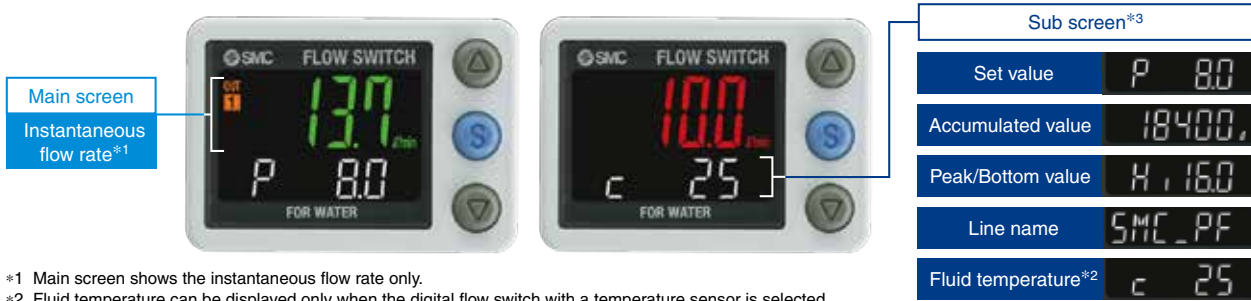

*1 Main screen shows the instantaneous flow rate only.

*2 Fluid temperature can be displayed only when the digital flow switch with a temperature sensor is selected.

*3 Sub screen can be turned off.

Mode display can be selected for IO-Link compatible type.

Compatible with the temperature sensor & flow adjustment valve



Fluid temperature: 0 to 90°C

Ethylene glycol aqueous solution can be used.

Example) Flow control of the circulating fluid in a chiller

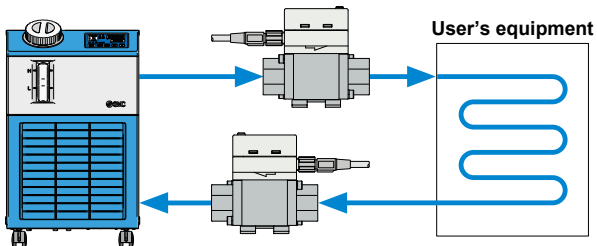

Non-grease

Rotatable display

Display can be rotated in increments of 45° to suit the installation conditions. Easy operation, improved visibility

- Counterclockwise 90°
- Clockwise 225°

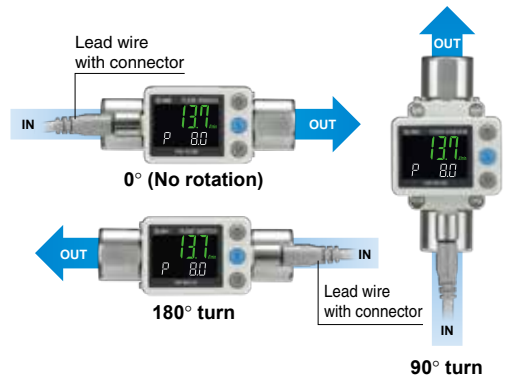

Remote Sensor Unit & 3-Color Display Digital Flow Monitor

Indicator

Visually check the status of the sensor via the indicator.

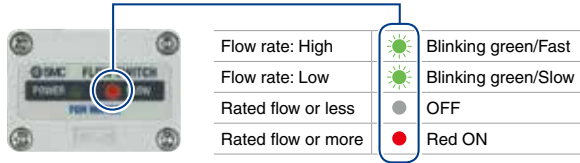

Set value copy function

The settings of the base monitor (source of copy) can be copied to the remote monitors.

- Reduced setting labor
- Minimized risk of setting mistakes

The set value can be copied to up to 10 flow monitors simultaneously.

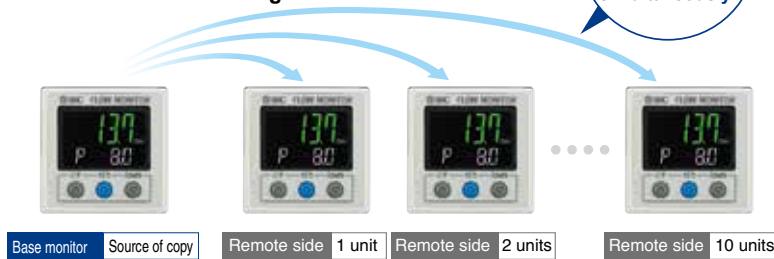

Connector reduces wiring labor.

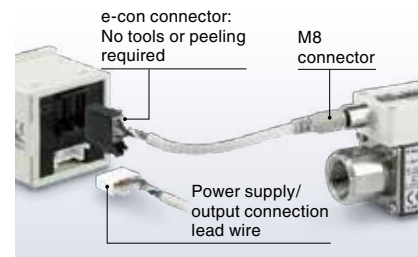

Mounting

Bracket mounting



Direct mounting

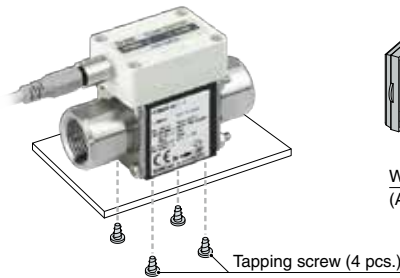

Panel mounting

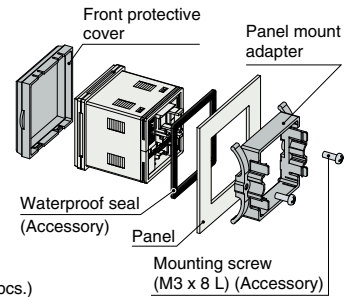

Digital Flow Switch for Water PF3W

Applicable fluid	Rated flow range [L/min]	Flow adjustment valve/Temperature sensor				Port size Rc, NPT, G
		None	Flow adjustment valve	Temperature sensor	Flow adjustment valve + Temperature sensor	
Flow range: 250 L type Water Ethylene glycol aqueous solution	50 to 250	●	—	●	—	1 1/4, 1 1/2
PVC piping type Deionized water Chemical liquids	10 to 100	●	—	—	—	25 A
	30 to 250	●	—	—	—	30 A

For details, refer to the Web Catalog.

IO-Link Compatible

Supports the IO-Link communication protocol

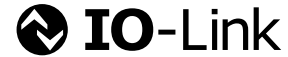

IO-Link is an open communication interface technology between the sensor/actuator and the I/O terminal that is an international standard, IEC61131-9.

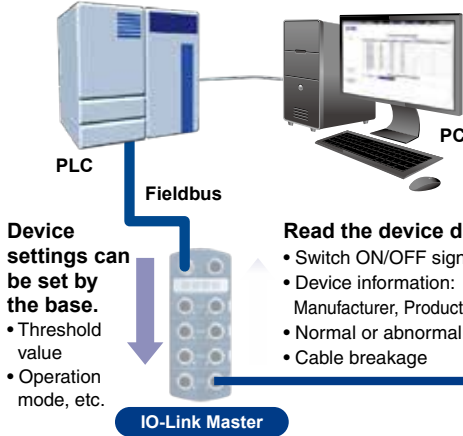

Configuration File (IODD File)*1
 • Manufacturer • Product part no. • Set value

*1 **IODD File:**
 IODD is an abbreviation of IO Device Description. This file is necessary for setting the device and connecting it to a base. Save the IODD file on the PC to be used to set the device prior to use.

Read the device data.

- Switch ON/OFF signal and analog value
- Device information: Manufacturer, Product part number, Serial number, etc.
- Normal or abnormal device status
- Cable breakage



IO-Link Compatible Device: Digital Flow Switch for Water

Implement diagnostic bits in the process data.

The diagnostic bit in the cyclic process data makes it easy to find problems with the equipment. It is possible to find problems with the equipment in real time using the cyclic (cycle) data and to monitor such problems in detail with the noncyclic (aperiodic) data.

Process Data

Bit offset	Item	Note
0	OUT1 output	0: OFF 1: ON
1	OUT2 output	0: OFF 1: ON
8	Diagnosis (flow rate)	0: OFF 1: ON
9	Diagnosis (temperature)	0: OFF 1: ON
15	Diagnosis (error)	0: OFF 1: ON
16 to 31	Measured temperature value	Signed 16 bit
32 to 47	Measured flow rate value	Signed 16 bit

Bit offset	Item	Diagnosis items														
47	46	45	44	43	42	41	40	39	38	37	36	35	34	33	32	Measured flow rate value (PD)
31	30	29	28	27	26	25	24	23	22	21	20	19	18	17	16	
Measured temperature value (PD) * The area is not used when the product without temperature sensor is selected.																
15	14	13	12	11	10	9	8	7	6	5	4	3	2	1	0	Diagnosis
Error		Reservation			Temperature	Flow rate	Reservation			OUT2		OUT1		Switch output		

Application Examples

For the predictive maintenance of cooling water problems

Monitors flow rate and temperature's "switch ON/OFF signals" and "analog values" to determine the cooling status. The process and cooling status can be compared.

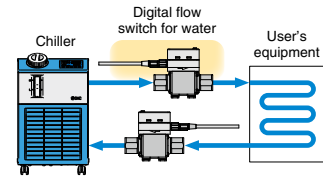

Display function

Displays the output communication status and indicates the presence of communication data



Operation and Display

Communication with base	IO-Link status indicator light	Status	Screen display*2	Description	
Yes	*1	Normal	Operate	Mode OPE	Normal communication status (readout of measured value)
			Start up	Mode Start	At the start of communication
			Preoperate	Mode Pre	
No	*1 (Flashing)	Abnormal	Version does not match	Er 15 V 1.0	The IO-Link version does not match that of the base. The master uses version 1.0.
			Lock	Mode LoE	Backup and restore required due to data storage lock.
			Communication disconnection	Mode OPE	Normal communication was not received for 1 second or longer.
				Mode Start	
No	OFF	SIO mode	Mode Sio	General switch output	

*1 In IO-Link mode, the IO-Link indicator will be ON or flashing. *2 When the lower line (sub screen) is set to mode display

CONTENTS

3-Color Display Digital Flow Switch for Water *PF3W-Z Series*

3-Color Display IO-Link Compatible
Digital Flow Switch for Water *PF3W7-L Series*

3-Color Display Digital Flow Monitor for Water *PF3W3 Series*



3-Color Display

Digital Flow Switch for Water PF3W-Z Series

Integrated Display

How to Order	p. 5
Specifications	p. 6
Temperature Sensor Specifications	p. 6

Remote Sensor Unit

How to Order	p. 7
Specifications	p. 8
Temperature Sensor Specifications	p. 8



3-Color Display

IO-Link Compatible Digital Flow Switch for Water PF3W7-L Series

How to Order	p. 9
Specifications (Integrated Display)	p. 10

Set Flow Range and Rated Flow Range	p. 11
Analog Output	p. 11
Operating Pressure and Proof Pressure	p. 11
Flow Rate Characteristics (Pressure Loss: Without Flow Adjustment Valve)	p. 12
Straight Piping Length and Accuracy (Reference Value)	p. 12
Flow Rate Characteristics of Flow Adjustment Valve	p. 13
Measurable Range for Ethylene Glycol Aqueous Solution (Reference Value)	p. 13
Wetted Parts Construction	p. 13
Internal Circuits and Wiring Examples	p. 14
Dimensions	p. 16



3-Color Display

Digital Flow Monitor for Water PF3W3 Series

How to Order	p. 21
Specifications	p. 22
Temperature Sensor Specifications	p. 22
Analog Output	p. 22
Internal Circuits and Wiring Examples	p. 23
Dimensions	p. 24

Function Details	p. 25
Safety Instructions	Back cover

PF3W7-Z Series

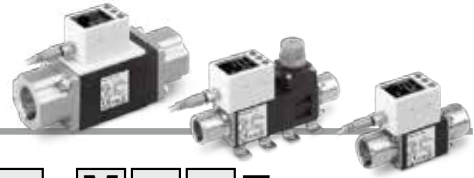

How to Order

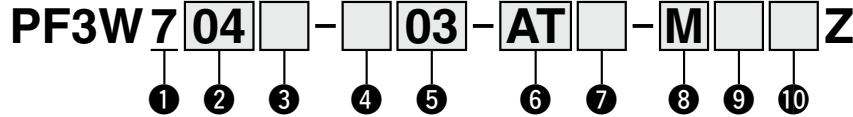

1 Type

7	Integrated display
---	--------------------

2 Rated flow range (Flow range)

Symbol	Rated flow range
04	0.5 to 4 L/min
20	2 to 16 L/min
40	5 to 40 L/min
11	10 to 100 L/min

3 Flow adjustment valve

Symbol	With/without flow adjustment valve	Rated flow range			
		04	20	40	11
Nil	None	●	●	●	●
S	Yes	●	●	●	—

* 100 L/min type with flow adjustment valve is not available.

* The flow adjustment valve of this product is not suitable for applications which require constant adjustment of flow rate.

4 Thread type

Nil	Rc
N	NPT
F	G*1

*1 ISO 228 compliant

5 Port size

Symbol	Port size	Rated flow range			
		04	20	40	11
03	3/8	●	●	—	—
04	1/2	—	●	●	—
06	3/4	—	—	●	●
10	1/1	—	—	—	●

7 Lead wire (Option)

Nil	N
With lead wire with M8 connector (3 m)	Without lead wire with M8 connector
* The lead wire with M8 connector is interchangeable with the existing PF3W series.	

6 Output specification/Temperature sensor

Symbol	OUT1	OUT2		Temperature sensor	
	Flow rate	Flow rate	Temperature		
A	NPN	NPN	—	None	
B	PNP	PNP	—		
C	NPN	Analog 1 to 5 V	—		
D	NPN	Analog 4 to 20 mA	—		
E	PNP	Analog 1 to 5 V	—		
F	PNP	Analog 4 to 20 mA	—		
G	NPN	External input*1	—		
H	PNP	External input*1	—		
AT	NPN	(NPN)	*2 NPN		With temperature sensor
BT	PNP	(PNP)	*2 PNP		
CT	NPN	(Analog 1 to 5 V)	*2 Analog 1 to 5 V		
DT	NPN	(Analog 4 to 20 mA)	*2 Analog 4 to 20 mA		
ET	PNP	(Analog 1 to 5 V)	*2 Analog 1 to 5 V		
FT	PNP	(Analog 4 to 20 mA)	*2 Analog 4 to 20 mA		

*1 External input: The accumulated value, peak value, and bottom value can be reset.

*2 For units with temperature sensor, only OUT2 can be set as either temperature output or flow rate output. Setting when shipped is for temperature output.

8 Integrated display/Unit specification

Symbol	Instantaneous flow	Accumulated flow	Temperature
M	L/min	L	°C
G	gal/min	gal	°C
F	gal/min	gal	°F
J	L/min	L	°F

* Under the New Measurement Act, units other than SI (symbol "M") cannot be used in Japan.

* G, F, J: Made to order

Reference: 1 [L/min] ↔ 0.2642 [gal/min]

1 [gal/min] ↔ 3.785 [L/min]

°F = 9/5°C + 32

9 Bracket (Option)

Nil	None
R	With bracket
	* Brackets are interchangeable with the existing PF3W series.

10 Calibration certificate (Only for flow rate)

Nil	None
A	With calibration certificate

* The certificate is written in both Japanese and English. Units with temperature sensor can only display the flow rate.

Options/Part Nos.

When only optional parts are required, order with the part numbers listed below.

Description	Part no.	Qty.	Note
Bracket*1	ZS-40-K	1	For PF3W704/720/504/520 With 4 tapping screws (3 x 8)
	ZS-40-L	1	For PF3W740/540 With 4 tapping screws (3 x 8)
	ZS-40-M	1	For PF3W711/511 With 4 tapping screws (4 x 10)
Lead wire with M8 connector	ZS-40-A	1	Lead wire length: 3 m

*1 For units with flow adjustment valve, 2 brackets are required.

* Interchangeable with the existing PF3W series

For flow switch precautions and specific product precautions, refer to the Operation Manual on the SMC website.

Specifications (Integrated Display)

Model	PF3W704	PF3W720	PF3W740	PF3W711
Applicable fluid	Water and Ethylene glycol aqueous solution (with viscosity of 3 mPa·s [3 cP] or less)* ¹			
Detection method	Karman vortex			
Rated flow range	0.5 to 4 L/min	2 to 16 L/min	5 to 40 L/min	10 to 100 L/min
Display flow range	0.35 to 5.50 L/min (Flow under 0.35 L/min is displayed as "0.00")	1.7 to 22.0 L/min (Flow under 1.7 L/min is displayed as "0.0")	3.5 to 55.0 L/min (Flow under 3.5 L/min is displayed as "0.0")	7 to 140 L/min (Flow under 7 L/min is displayed as "0")
Set flow range	0.35 to 5.50 L/min	1.7 to 22.0 L/min	3.5 to 55.0 L/min	7 to 140 L/min
Smallest settable increment	0.01 L/min	0.1 L/min		1 L/min
Conversion of accumulated pulse (Pulse width: 50 ms)	0.05 L/pulse	0.1 L/pulse	0.5 L/pulse	1 L/pulse
Fluid temperature	0 to 90°C (No freezing or condensation)			
Display unit	Instantaneous flow: L/min, Accumulated flow: L			
Accuracy	Display value: ±3% F.S. Analog output: ±3% F.S.			
Repeatability	±2% F.S.* ²			
Temperature characteristics	±5% F.S. (25°C standard)			
Operating pressure range * ³	0 to 1 MPa			
Proof pressure * ³	1.5 MPa			
Pressure loss (without flow adjustment valve)	45 kPa or less at the maximum flow			
Accumulated flow range * ⁴	99999999.9 L		999999999 L	
	By 0.1 L	By 0.5 L	By 1 L	
Switch output	NPN or PNP open collector output			
Max. load current	80 mA			
Max. applied voltage	28 VDC			
Internal voltage drop	NPN: 1 V or less (at load current of 80 mA) PNP: 1.5 V or less (at load current of 80 mA)			
Response time * ^{2, 5}	0.5 s/1 s/2 s			
Output protection	Short-circuit protection			
Output mode	Select from Hysteresis, Window comparator, Accumulated output, or Accumulated pulse output modes.			
Flow rate mode	Select from Hysteresis mode or Window comparator mode.			
Temperature mode				
Response time * ⁶	0.5 s/1 s/2 s (linked with the switch output)			
Analog output	Voltage output: 1 to 5 V Output impedance: 1 kΩ			
Voltage output				
Current output	Output current: 4 to 20 mA Max. load impedance: 300 Ω for 12 VDC, 600 Ω for 24 VDC			
Hysteresis	Variable			
External input	Voltage free input: 0.4 V or less (Reed or Solid state), input for 30 ms or longer			
Display method	2-screen display (Main screen: 4-digit, 7-segment, 2-color, Red/Green Sub screen: 6-digit, 11-segment, White) Display values updated 5 times per second			
Indicator light	Output 1, Output 2: Orange			
Power supply voltage	12 to 24 VDC ±10%			
Current consumption	50 mA or less			
Environmental resistance	IP65			
Enclosure				
Operating temperature range	0 to 50°C (No freezing or condensation)			
Operating humidity range	Operation, Storage: 35 to 85% R.H. (No condensation)			
Withstand voltage * ⁷	1000 VAC for 1 minute between terminals and housing			
Insulation resistance	50 MΩ or more (500 VDC measured via megohmmeter) between terminals and housing			
Standards and regulations	CE marking (EMC directive/RoHS directive), UL (CSA)			
Wetted parts material * ⁸	PPS, Stainless steel 304, FKM, SCS13			
	Non-grease			
Piping port size * ⁹	3/8	3/8, 1/2	1/2, 3/4	3/4, 1
Weight				
Without temperature sensor/Without flow adjustment valve	153 g	171 g	228 g	720 g
With temperature sensor/Without flow adjustment valve	166 g	184 g	248 g	748 g
Without temperature sensor/With flow adjustment valve	241 g	259 g	429 g	—
With temperature sensor/With flow adjustment valve	254 g	272 g	449 g	—
With lead wire with connector	+85 g			

*¹ Refer to the graph of measurable range for ethylene glycol aqueous solution on page 13. Measurement is possible as long as the fluid does not corrode the wetted parts and viscosity is 3 mPa·s (3 cP) or less. Be aware that water leakage may occur due to internal seal shrinkage or swelling depending on the type of fluid.

*² If 0.5 s is selected for the response time of the switch output, the repeatability will be ±3% F.S.

*³ The operating pressure range and proof pressure may change according to the fluid temperature. Refer to the graphs on page 11.

*⁴ Cleared when the power supply is turned off. The hold function can be selected. (Intervals of 2 or 5 minutes can be selected.)

*⁵ If the 5-minute interval is selected, the life of the memory element (electronic parts) is limited to 1 million times. (If energized for 24 hours, life is calculated as 5 minutes x 1 million = 5 million minutes = about 9.5 years.) Therefore, if using the hold function, calculate the memory life for your operating conditions, and use within this life.

*⁶ The response time when the set value is 90% in relation to the step input (The response time is 7 s when it is output by the temperature sensor.)

*⁷ The response time until the set value reaches 90% in relation to the step input (The response time is 7 s when it is analog output by the temperature sensor.)

*⁸ When the temperature sensor is used, it will be 250 VAC.

*⁹ For details, refer to the "Wetted Parts Construction" on page 13.

* When the piping diameter or piping passage is restricted, the specifications may not be satisfied.

* Products with tiny scratches, marks, or display color or brightness variations which do not affect the performance of the product are verified as conforming products.

Temperature Sensor Specifications

Rated temperature range	0 to 100°C* ¹
Set/Display temperature range	-10 to 110°C
Smallest settable increment	1°C
Display unit	°C
Display accuracy	±2°C
Analog output accuracy	±3% F.S.
Response time	7 s* ²
Ambient temperature characteristics	±5% F.S.

*¹ The rated temperature range refers solely to that of the temperature sensor. The fluid temperature range specification of the flow switch as a whole is 0 to 90°C.

*² The response time refers solely to that of the temperature sensor.

The output related to the temperature sensor is OUT2 only.

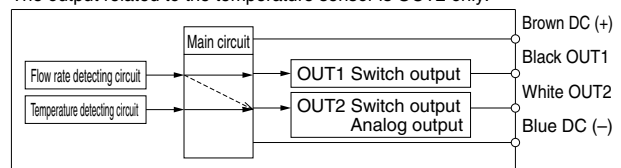

The OUT2 can be selected from either the output for temperature or flow rate by button operation.

PF3W5-Z Series



How to Order

PF3W 5 **04** - **03** - **1T** - **Z**

1
2
3
4
5
6
7
8
9
10

1 Type

5	Remote sensor unit
---	--------------------

2 Rated flow range (Flow range)

Symbol	Rated flow range
04	0.5 to 4 L/min
20	2 to 16 L/min
40	5 to 40 L/min
11	10 to 100 L/min

3 Flow adjustment valve

Symbol	With/without flow adjustment valve	Rated flow range			
		04	20	40	11
Nil	None	●	●	●	●
S	Yes	●	●	●	—

* 100 L/min type with flow adjustment valve is not available.

* The flow adjustment valve of this product is not suitable for applications which require constant adjustment of flow rate.

4 Thread type

Nil	Rc
N	NPT
F	G*1

*1 ISO 228 compliant

5 Port size

Symbol	Port size	Rated flow range			
		04	20	40	11
03	3/8	●	●	—	—
04	1/2	—	●	●	—
06	3/4	—	—	●	●
10	1/1	—	—	—	●

6 Output specification/Temperature sensor

Symbol	OUT1	OUT2	Temperature sensor
	Flow rate	Temperature	
1	Analog 1 to 5 V	—	None
2	Analog 4 to 20 mA	—	
1T	Analog 1 to 5 V	Analog 1 to 5 V	With temperature sensor

* To use in combination with remote monitor (PF3W3 series), select analog output of 1 to 5 V of flow rate (output symbol "-1" or "-1T").

7 Lead wire (Option)

Nil	With lead wire with M8 connector (3 m)
N	Without lead wire with M8 connector

* The lead wire with M8 connector is interchangeable with the existing PF3W series.

8 Remote sensor unit/Unit printed on label

Symbol	Instantaneous flow	Temperature
Nil	L/min	°C
G*1	L/min (gal/min)	°C/°F

*1 Under the New Measurement Act, units other than SI (symbol "Nil") cannot be used in Japan.

* G: Made to order

Reference: 1 [L/min] ↔ 0.2642 [gal/min]
 1 [gal/min] ↔ 3.785 [L/min]
 °F = 9/5°C + 32

9 Bracket (Option)

Nil	None
R	With bracket

* Brackets are interchangeable with the existing PF3W series.

10 Calibration certificate (Only for flow rate)

Nil	None
A	With calibration certificate

* The certificate is written in both Japanese and English.

Units with temperature sensor can only display the flow rate.

Options/Part Nos.

When only optional parts are required, order with the part numbers listed below.

Description	Part no.	Qty.	Note	
Bracket*1	ZS-40-K	1	For PF3W704/720/504/520	With 4 tapping screws (3 x 8)
	ZS-40-L	1	For PF3W740/540	With 4 tapping screws (3 x 8)
	ZS-40-M	1	For PF3W711/511	With 4 tapping screws (4 x 10)
Lead wire with M8 connector	ZS-40-A	1	Lead wire length: 3 m	

*1 For units with flow adjustment valve, 2 brackets are required.

* Interchangeable with the existing PF3W series

For flow switch precautions and specific product precautions, refer to the Operation Manual on the SMC website.

Specifications (Remote Sensor Unit)

Model		PF3W504	PF3W520	PF3W540	PF3W511
Applicable fluid		Water and Ethylene glycol aqueous solution (with viscosity of 3 mPa·s [3 cP] or less)*1			
Detection method		Karman vortex			
Rated flow range		0.5 to 4 L/min	2 to 16 L/min	5 to 40 L/min	10 to 100 L/min
Fluid temperature		0 to 90°C (No freezing or condensation)			
Accuracy		±3% F.S.			
Repeatability		±2% F.S.			
Temperature characteristics		±5% F.S. (25°C standard)			
Operating pressure range *2		0 to 1 MPa*2			
Proof pressure *2		1.5 MPa			
Pressure loss (without flow adjustment valve)		45 kPa or less at the maximum flow			
Analog output		1 s			
Response time *3		1 s			
Voltage output		Voltage output: 1 to 5 V Output impedance: 1 kΩ			
Current output		Output current: 4 to 20 mA Max. load impedance: 300 Ω for 12 VDC, 600 Ω for 24 VDC			
Indicator light		For power supply status, flow rate indicator (Blinking speed changes in response to flow rate.), and other error indicator			
Power supply voltage		12 to 24 VDC ±10%			
Current consumption		30 mA or less			
Environmental resistance		IP65			
Enclosure		IP65			
Operating temperature range		0 to 50°C (No freezing or condensation)			
Operating humidity range		Operation, Storage: 35 to 85% R.H. (No condensation)			
Withstand voltage *4		1000 VAC for 1 minute between terminals and housing			
Insulation resistance		50 MΩ or more (500 VDC measured via megohmmeter) between terminals and housing			
Standards and regulations		CE marking (EMC directive/RoHS directive), UL (CSA)			
Wetted parts material *5		PPS, Stainless steel 304, FKM, SCS13			
Piping port size *6		Non-grease			
Weight		3/8	3/8, 1/2	1/2, 3/4	3/4, 1
Without temperature sensor/Without flow adjustment valve		138 g	156 g	213 g	705 g
With temperature sensor/Without flow adjustment valve		151 g	169 g	233 g	728 g
Without temperature sensor/With flow adjustment valve		226 g	244 g	414 g	—
With temperature sensor/With flow adjustment valve		239 g	257 g	434 g	—
With lead wire with connector		+85 g			

- *1 Refer to the graph of measurable range for ethylene glycol aqueous solution on page 13. Measurement is possible as long as the fluid does not corrode the wetted parts and viscosity is 3 mPa·s (3 cP) or less. Be aware that water leakage may occur due to internal seal shrinkage or swelling depending on the type of fluid.
- *2 The operating pressure range and proof pressure may change according to the fluid temperature. Refer to the graphs on page 11.
- *3 The response time until the set value reaches 90% in relation to the step input (The response time is 7 s when it is analog output by the temperature sensor.)

- *4 When the temperature sensor is used, it will be 250 VAC.
- *5 For details, refer to the "Wetted Parts Construction" on page 13.
- *6 When the piping diameter or piping passage is restricted, the specifications may not be satisfied.
- * Products with tiny scratches, marks, or display color or brightness variations which do not affect the performance of the product are verified as conforming products.

Temperature Sensor Specifications

Rated temperature range	0 to 100°C*1
Analog output accuracy	±3% F.S.
Response time	7 s*2
Ambient temperature characteristics	±5% F.S.

- *1 The rated temperature range refers solely to that of the temperature sensor. The fluid temperature range specification of the flow switch as a whole is 0 to 90°C.

- *2 The response time refers solely to that of the temperature sensor.

PF3W7-L Series



How to Order

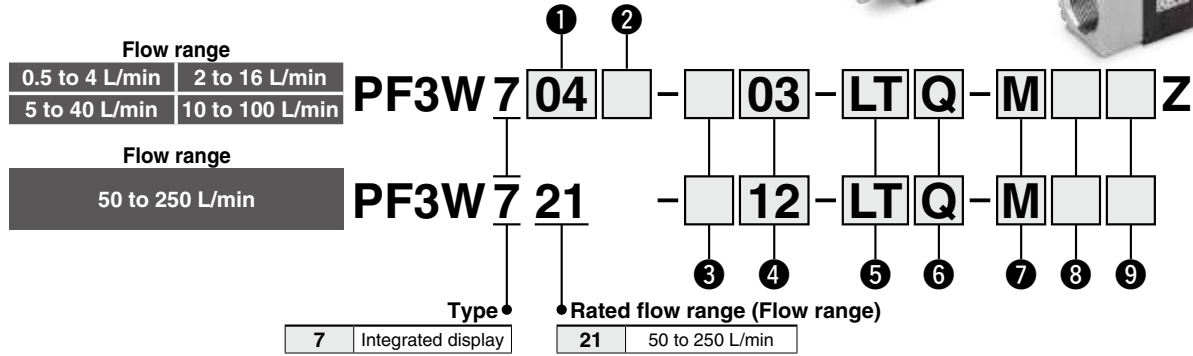

1 Rated flow range (Flow range)

04	0.5 to 4 L/min
20	2 to 16 L/min
40	5 to 40 L/min
11	10 to 100 L/min

2 Flow adjustment valve

Symbol	With/without flow adjustment valve	Rated flow range			
		04	20	40	11
Nil	None	●	●	●	●
S	Yes	●	●	●	—

* 100 L/min type with flow adjustment valve is not available.

* The flow adjustment valve of this product is not suitable for applications which require constant adjustment of flow rate.

3 Thread type

Nil	Rc
N	NPT
F	G*1

*1 ISO 228 compliant

4 Piping port size

Symbol	Port size	Rated flow range				
		04	20	40	11	21
03	3/8	●	●	—	—	—
04	1/2	—	●	●	—	—
06	3/4	—	—	●	●	—
10	1	—	—	—	●	—
12	1-1/4	—	—	—	—	●
14	1-1/2	—	—	—	—	●

5 Output specification/Temperature sensor

Symbol	OUT1	OUT2	Temperature sensor
	Flow rate/Temperature	Flow rate/Temperature	
L	IO-Link/Switch output (N/P)	—	None
L2	IO-Link/Switch output (N/P)	Switch output (N/P)	
LT	IO-Link/Switch output (N/P)	—	Yes
L2T	IO-Link/Switch output (N/P)	Switch output (N/P)	

* Temperature output or flow output can be selected for a digital flow switch with temperature sensor.
* The output specification of L, L2, and L2T should be ordered as made to order.

6 Lead wire (Option)

Nil	With lead wire with M8 connector (3 m)
N	None
Q	With M12-M8 conversion lead wire (0.1 m)*1

*1 A 3 m lead wire is also available separately.

* The lead wire with M8 connector and the M12-M8 conversion lead wire are interchangeable with the existing PF3W series.

7 Integrated display/Unit specification

Symbol	Instantaneous flow	Accumulated flow	Temperature
Nil	gal/min	gal	°C
M	L/min	L	°C

* Under the New Measurement Act, units other than SI (symbol "M") cannot be used in Japan.

* Reference: 1 [L/min] ↔ 0.2642 [gal/min]
1 [gal/min] ↔ 3.785 [L/min]

8 Bracket (Option)

Nil	None
R	With bracket

* Brackets are interchangeable with the existing PF3W series.

9 Calibration certificate (Only for flow rate)

Nil	None
A	With calibration certificate

* The certificate is written in both Japanese and English.
The integrated display type with temperature sensor can only display the flow rate.
The temperature sensor is not calibrated.

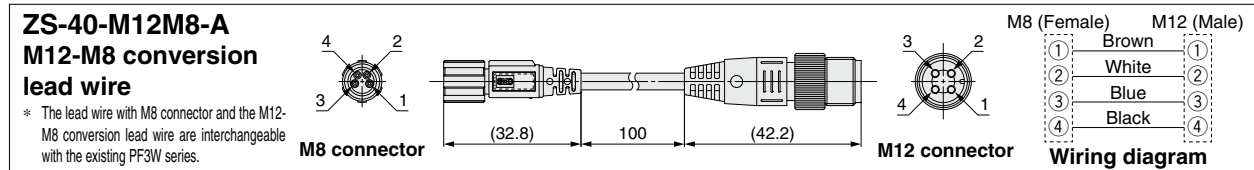

* For wiring, refer to the Operation Manual on the SMC website.

For flow switch precautions and specific product precautions, refer to the Operation Manual on the SMC website.

Specifications (Integrated Display)

Model		PF3W704-L	PF3W720-L	PF3W740-L	PF3W711-L	PF3W721-L
Accumulated flow range*1		999999999.9 L			999999999 L	
		By 0.1 L			By 1 L	
Switch output	Maximum applied voltage	30 V (NPN output)				
	Internal voltage drop	1.5 V or less (at load current of 80 mA)				
	Delay time*2	3.5 ms Variable from 0 to 60 s/0.01 s increments				
Output mode	Flow rate	Select from Hysteresis, Window comparator, Accumulated output, Accumulated pulse output, Error output, or Switch output OFF modes.				
Power supply voltage	When used as a switch output device	12 to 24 VDC, including ripple (p-p) 10%				
	When used as an IO-Link device	18 to 30 VDC, including ripple (p-p) 10%				
Digital filter*3		Select from 0.5 s, 1.0 s, 2.0 s, 5.0 s, 10.0 s, 15.0 s, 20.0 s, or 30.0 s.				
Environment	Withstand voltage	250 VAC for 1 minute between external terminals and case				
Standards and regulations		CE marking (EMC directive/RoHS directive)				

- *1 Cleared when the power supply is turned off
The hold function can be selected. If the 5-minute interval is selected, the life of the memory element (electronic parts) is limited to 3.7 million times. (If energized for 24 hours, life is calculated as 5 minutes x access times (3.7 million) = 18.5 million minutes = about 35 years.) Therefore, if using the hold function, calculate the memory life for your operating conditions, and use within this life.
- *2 Does not include the value of the digital filter
- *3 The response time until the set value reaches 90% in relation to the step input (The response time is 7 s when it is output by the temperature sensor.)

Communication Specifications (IO-Link mode)

IO-Link type	Device
IO-Link version	V1.1
Communication speed	COM2 (38.4 kbps)
Configuration file	IODD file*1
Minimum cycle time	3.5 ms
Process data length	Input data: 6 bytes, Output data: 0 byte
On request data communication	Yes
Data storage function	Yes
Event function	Yes
Vendor ID	131 (0 x 0083)
Device ID*2	PF3W704□-□□-□□□□□□□□Z : 352 (0 x 0160) PF3W720□-□□-□□□□□□□□Z : 353 (0 x 0161) PF3W740□-□□-□□□□□□□□Z : 354 (0 x 0162) PF3W711□-□□-□□□□□□□□Z : 355 (0 x 0163) PF3W721□-□□-□□□□□□□□ : 356 (0 x 0164) PF3W704□-□□-□□□□□□□□Z : 357 (0 x 0165) PF3W720□-□□-□□□□□□□□Z : 358 (0 x 0166) PF3W740□-□□-□□□□□□□□Z : 359 (0 x 0167) PF3W711□-□□-□□□□□□□□Z : 360 (0 x 0168) PF3W721□-□□-□□□□□□□□ : 361 (0 x 0169)

- *1 The configuration file can be downloaded from the SMC website.
- *2 The device ID differs according to each product type (flow range, whether or not a temperature sensor is provided, etc.).

PF3W-Z/L Series

Set Flow Range and Rated Flow Range



Caution Set the flow rate within the rated flow range.

The set flow range is the range of flow rate within which setting is possible. The rated flow range is the range within which the sensor specifications (accuracy, etc.) are satisfied. It is possible to set a value outside of the rated flow range if it is within the set flow range. However, the satisfaction of the specifications cannot be guaranteed.

Sensor	Flow range									
	0.5 L/min	2 L/min	5 L/min	20 L/min	40 L/min	100 L/min	140 L/min	250 L/min	350 L/min	
PF3W704	0.5 L/min — 4 L/min									
PF3W504	0.35 L/min — 5.5 L/min									
PF3W720	2 L/min — 16 L/min									
PF3W520	1.7 L/min — 22 L/min									
PF3W740	5 L/min — 40 L/min									
PF3W540	3.5 L/min — 55 L/min									
PF3W711	10 L/min — 100 L/min									
PF3W511	7 L/min — 140 L/min									
PF3W721	20 L/min — 350 L/min									

* For the PF3W5 series, the display flow range and set flow range are the same as those of the flow monitor PF3W3 series.

Rated flow range Display flow range Set flow range

Analog Output

Flow rate/Analog output

	A		B		C	
	4/16/40	100	250			
Voltage output	1 V	1.5 V	1.4 V	1.8 V	5 V	
Current output	4 mA	6 mA	5.6 mA	7.2 mA	20 mA	

Model	Rated flow [L/min]	
	Minimum	Maximum
PF3W704/504	0.5	4
PF3W720/520	2	16
PF3W740/540	5	40
PF3W711/511	10	100

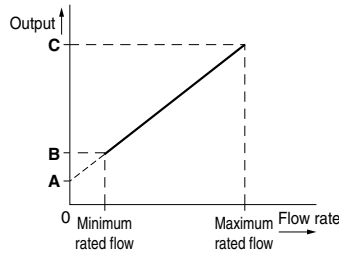

Fluid temperature/Analog output

	A		B	
	Voltage output	0.6 V	1 V	
Current output	2.4 mA	4 mA		

	C		D	
	Voltage output	5 V	5.4 V	
Current output	20 mA	21.6 mA		

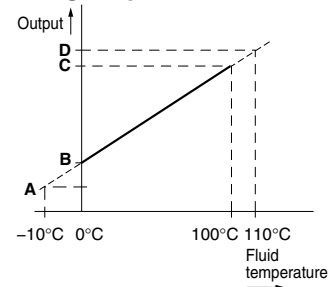

Operating Pressure and Proof Pressure

PF3W704(-L)/720(-L)/740(-L)/504/520/540

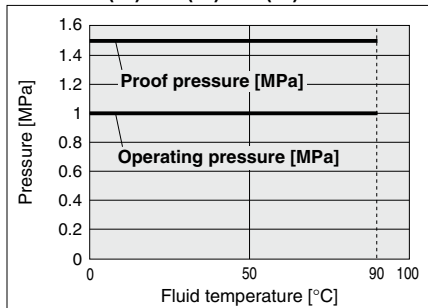

PF3W704S(-L)/720S(-L)/740S(-L)/504S/520S/540S

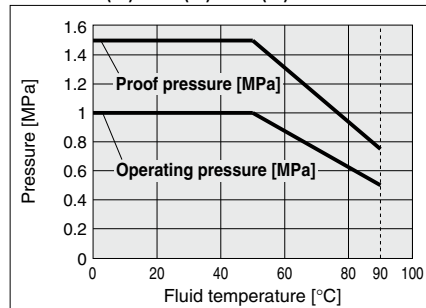

PF3W711(-L)/511

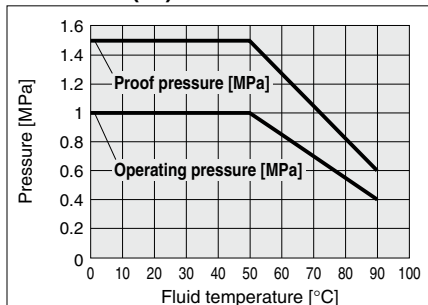

PF3W721(-L)

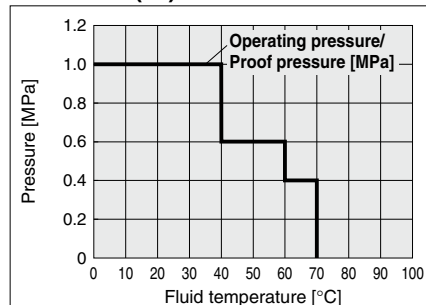

Flow Rate Characteristics (Pressure Loss: Without Flow Adjustment Valve)

PF3W704(-L)/504

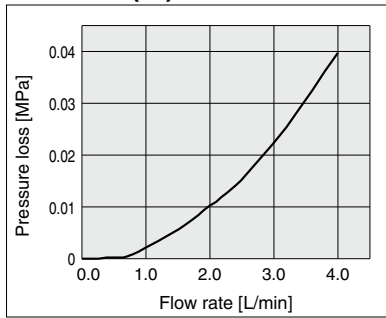

PF3W720(-L)/520

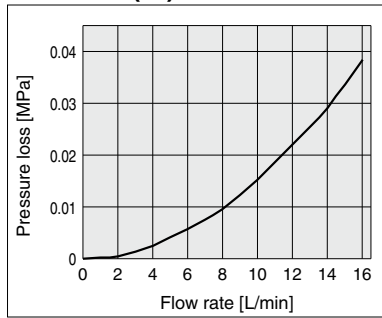

PF3W740(-L)/540

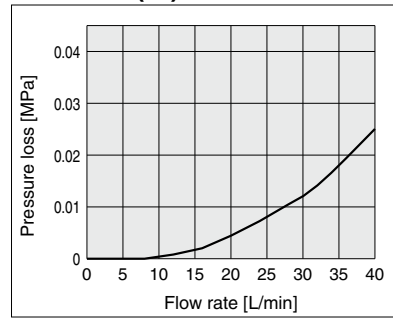

PF3W711(-L)/511

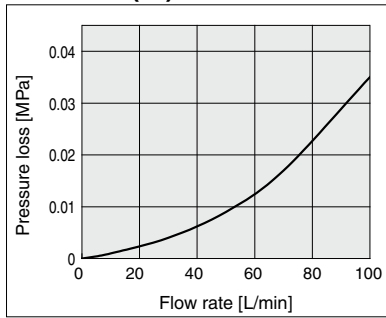

PF3W721(-L)

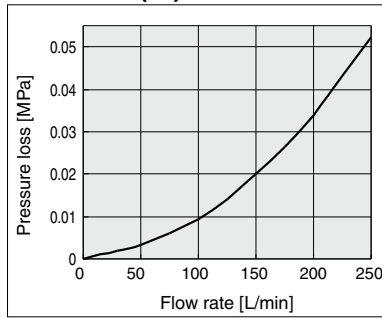

Straight Piping Length and Accuracy (Reference Value)

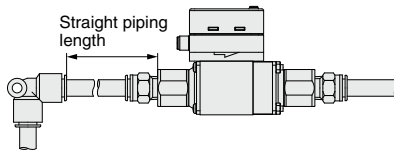

- The smaller the piping size, the more the product is affected by the straight piping length.
- Fluid pressure has almost no affect.
- Low flow rate lessens the effect of the straight piping length.
- Use a straight pipe that is 8 cm or longer in length to satisfy the $\pm 3\%$ F.S. specification. (11 cm or longer for the 100 L/min type)

PF3W704(-L)/504 Pressure: 0.3 MPa Piping diameter: $\phi 12$

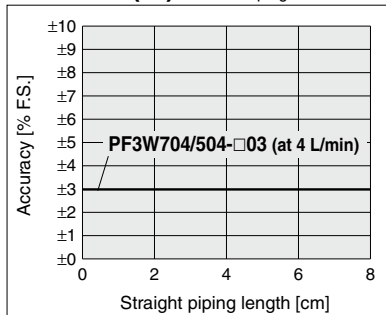

PF3W720(-L)/520 Pressure: 0.3 MPa Piping diameter: $\phi 12$

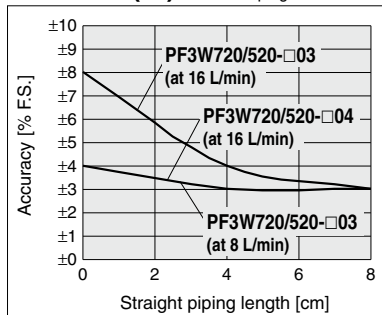

PF3W740(-L)/540 Pressure: 0.3 MPa Piping diameter: $\phi 16$

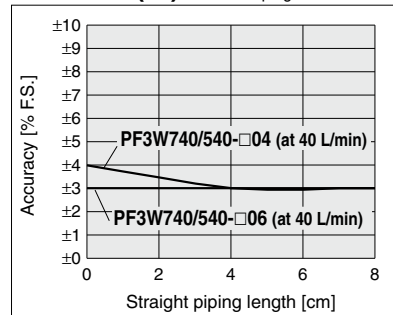

PF3W711(-L)/511 Pressure: 0.3 MPa Piping diameter: 25A (Port size 10) 20A (Port size 06)

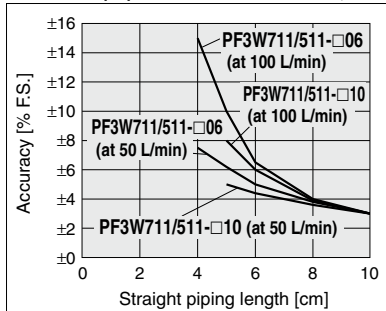

PF3W721(-L) Pressure: 0.3 MPa Piping diameter: 32A (Port size 12) 40A (Port size 14)

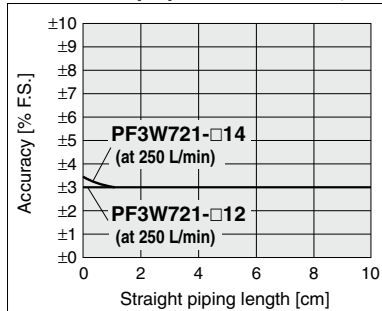

* No data for 4 cm, or for under 5 cm, as these cannot be used due to piping dimensions.

PF3W-Z/L Series

Flow Rate Characteristics of Flow Adjustment Valve

PF3W704S(-L)/504S

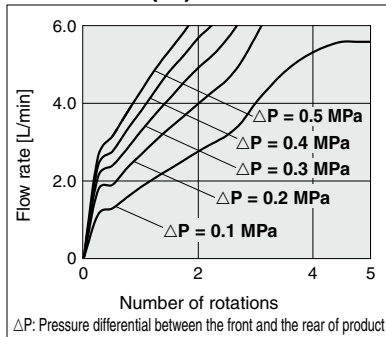

PF3W720S(-L)/520S

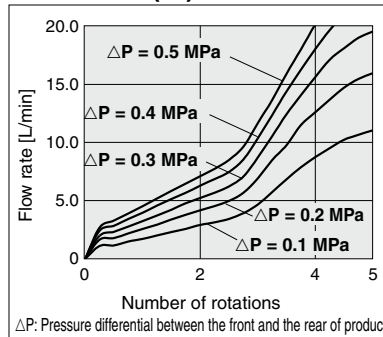

PF3W740S(-L)/540S

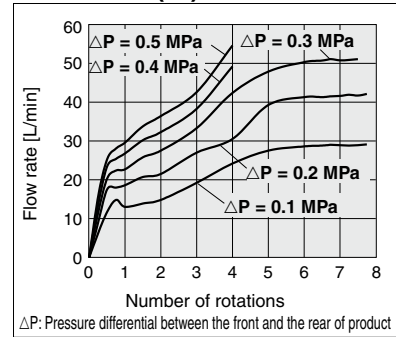

Measurable Range for Ethylene Glycol Aqueous Solution (Reference Value)

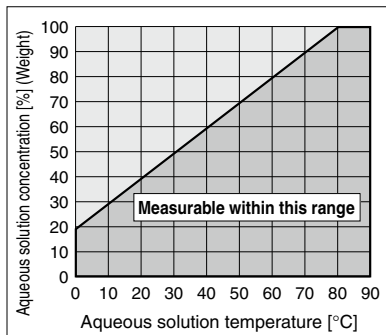

Wetted Parts Construction

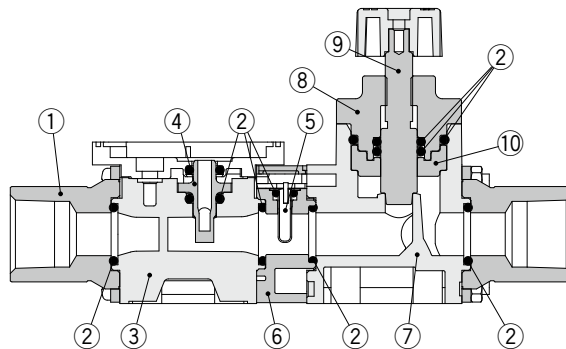

Component Parts

No.	Description	Material	Note
1	Attachment	Stainless steel 304	PF3W704/720/740/504/520/540
		SCS13	Stainless steel 304 equivalent, PF3W711/511
2	Seal	FKM	
3	Body	PPS	
4	Sensor	PPS	
5	Temperature sensor	Stainless steel 304	
6	Temperature sensor body	PPS	
7	Flow adjustment valve body	PPS	
8	Flow adjustment valve cover	PPS	
9	Flow adjustment valve shaft	Stainless steel 304	
10	Shaft support	PPS	

Internal Circuits and Wiring Examples

PF3W7□□

-A(T)
NPN (2 outputs)

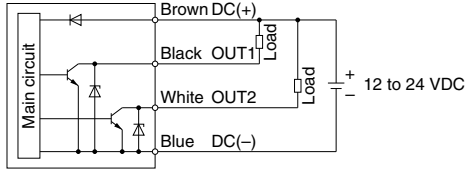

-E(T)/F(T)
E(T): PNP + Analog voltage output
F(T): PNP + Analog current output

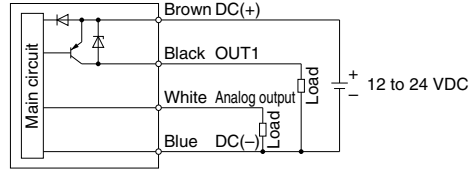

-B(T)
PNP (2 outputs)

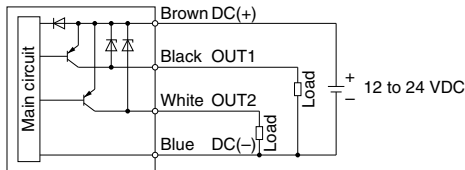

-G
NPN + External input

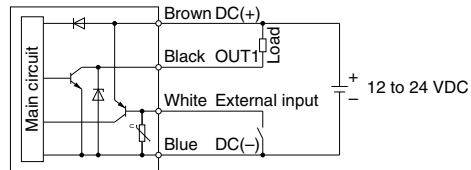

-C(T)/D(T)
C(T): NPN + Analog voltage output
D(T): NPN + Analog current output

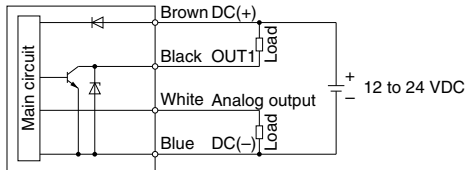

-H
PNP + External input

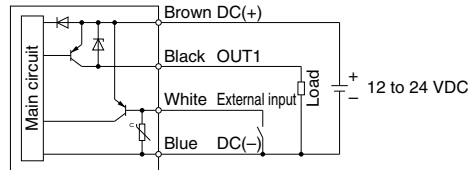

Accumulated pulse output wiring examples

-A(T)/C(T)/D(T)/G
A(T): NPN (2 outputs)
C(T), D(T): NPN + Analog output
G: NPN + External input

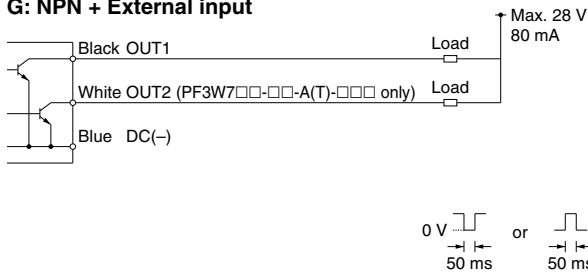

-B(T)/E(T)/F(T)/H
B(T): PNP (2 outputs)
E(T), F(T): PNP + Analog output
H: PNP + External input

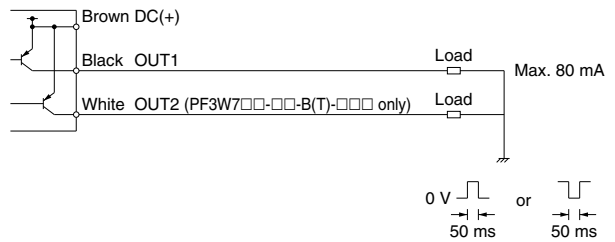

PF3W5□□

-1/2
1: Analog voltage output
2: Analog current output

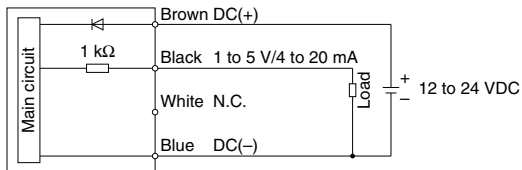

-1T
Analog voltage output
(With temperature sensor output)

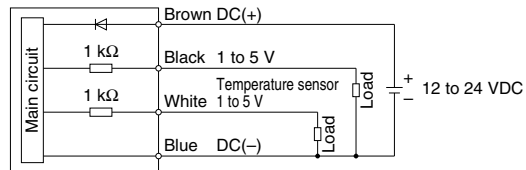

PF3W-Z/L Series

Internal Circuits and Wiring Examples

PF3W7□□-L

NPN output type

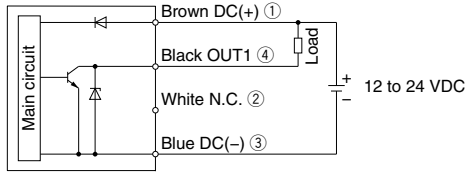

Max. 28 V, 80 mA
Internal voltage drop 1.5 V or less

PNP output type

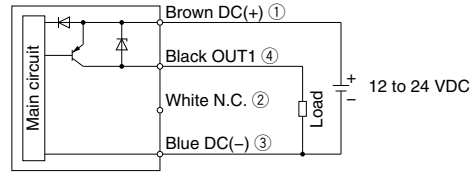

Max. 80 mA
Internal voltage drop 1.5 V or less

PF3W7□□-L2

NPN 2 output type

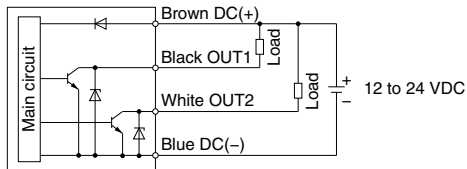

Max. 28 V, 80 mA
Internal voltage drop 1.5 V or less

PNP 2 output type

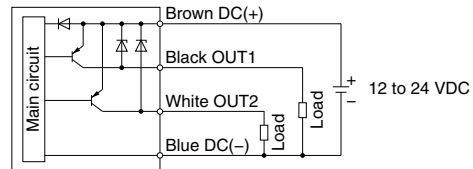

Max. 80 mA
Internal voltage drop 1.5 V or less

When used as an IO-Link device

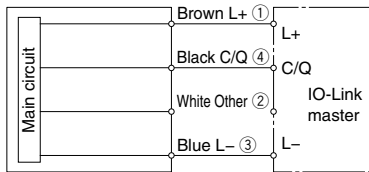

* The numbers in the diagrams show the connector pin layout.

Dimensions

PF3W704(-L)/720(-L)/740(-L)/711(-L)/721(-L) Integrated display

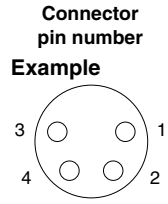

Pin no.	Pin name
1	DC(+)
2	OUT2
3	DC(-)
4	OUT1

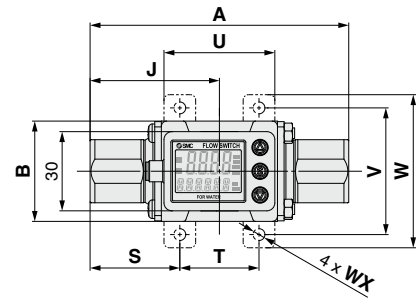
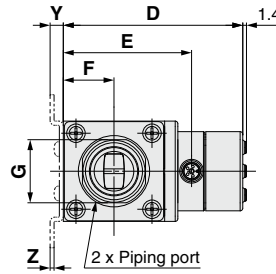

Piping port: G thread

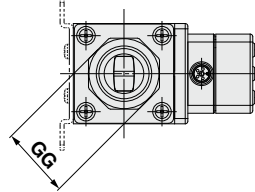

Model	Port size G	GG
PF3W704	3/8	23.9
PF3W720	3/8	23.9
	1/2	26.9
PF3W740	1/2	26.9
	3/4	31.9

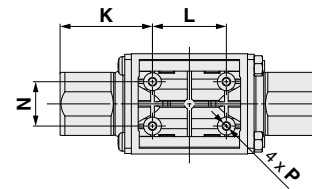
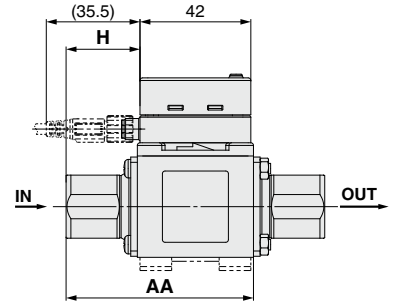

For PF3W711(-L)

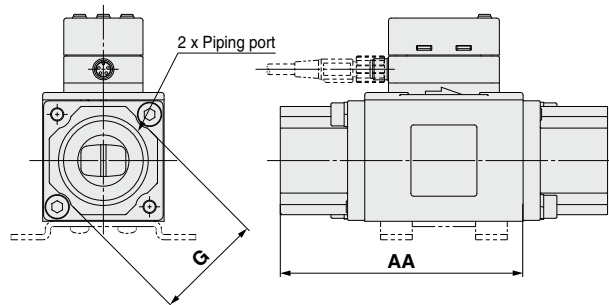

For PF3W721(-L)

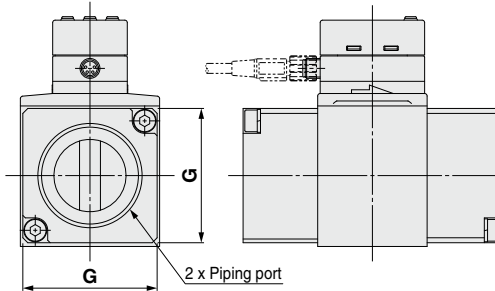

Model	Port size (Rc, NPT)															Bracket dimensions							
		A	AA	B	D	E	F	G	H	J	K	L	N	P	S	T	U	V	W	WX	Y	Z	
PF3W704(-L)	3/8	70	50	30	60	40.6	15.2	20.9	14	35	26	18	13.6	ø2.7 depth 14	24	22	32	40	50	4.5	5	1.5	
PF3W720(-L)	3/8, 1/2	78	54	30	60	40.6	15.2	20.9	18	39	30	18	13.6	ø2.7 depth 12	28	22	32	40	50	4.5	5	1.5	
								23.9															
PF3W740(-L)	1/2, 3/4	98	71	38	68	48.6	19.2	23.9	28	49	35	28	16.8	ø2.7 depth 12	34	30	42	48	58	4.5	5	1.5	
								29.9															
PF3W711(-L)	3/4, 1	124	92	46	77	57.6	23.0	41	41	63	48	28	18.0	ø3.5 depth 14	44	36	48	58	70	5.5	7	2.0	
	1 1/4, 1 1/2	104	74	56	91	71.6	28.5	54	31	52	39.5	25	27.5	ø3.5 depth 14	—	—	—	—	—	—	—	—	
	G1 1/4	108	76						33	54	41.5												
PF3W721-L	G1 1/4	108	76	56	91	71.6	28.5	54	33	54	41.5	25	27.5	ø3.5 depth 14	—	—	—	—	—	—	—	—	
	G1 1/2	112	78						35	56	43.5												

PF3W-Z/L Series

Dimensions

PF3W504/520/540/511 Remote sensor unit

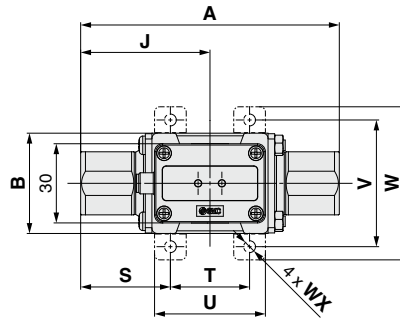
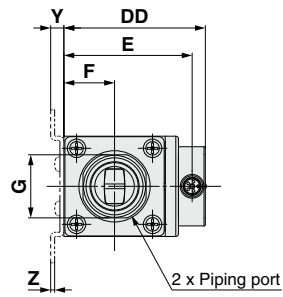

Piping port: G thread

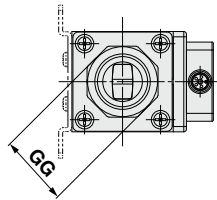

Model	Port size G	GG
PF3W504	3/8	23.9
PF3W520	3/8	23.9
	1/2	26.9
PF3W540	1/2	26.9
	3/4	31.9

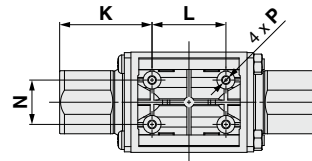
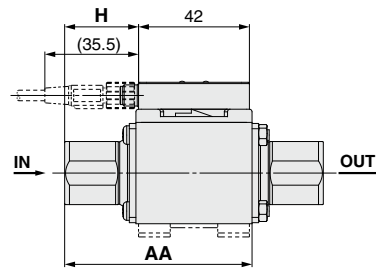

[mm]

Model	Port size (Rc, NPT)	A	AA	B	DD	E	F	G	H	J	K	L	N	P	Bracket dimensions							
															S	T	U	V	W	WX	Y	Z
PF3W504	3/8	70	50	30	45.6	40.6	15.2	20.9	14	35	26	18	13.6	ø2.7 depth 14	24	22	32	40	50	4.5	5	1.5
PF3W520	3/8, 1/2	78	54	30	45.6	40.6	15.2	20.9	18	39	30	18	13.6	ø2.7 depth 12	28	22	32	40	50	4.5	5	1.5
								23.9														
PF3W540	1/2, 3/4	98	71	38	53.6	48.6	19.2	23.9	28	49	35	28	16.8	ø2.7 depth 12	34	30	42	48	58	4.5	5	1.5
								29.9														
PF3W511	3/4, 1	124	92	46	62.6	57.6	23.0	41	41	63	48	28	18.0	ø3.5 depth 14	44	36	48	58	70	5.5	7	2.0

Dimensions

PF3W704/720/740-□-□T

PF3W704/720/740-L□T

Integrated display: With temperature sensor

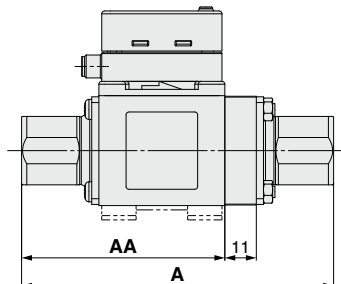

PF3W504/520/540-□-□T

Remote sensor unit: With temperature sensor

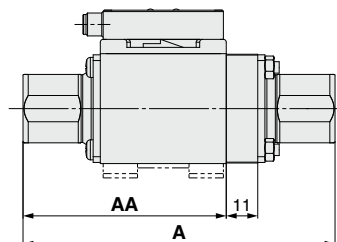

Model	[mm]	
	A	AA
PF3W704/504-□-□T	81	50
PF3W720/520-□-□T	89	54
PF3W740/540-□-□T	109	71

PF3W711/721-□-□T

PF3W711/721-L□T

Integrated display: With temperature sensor

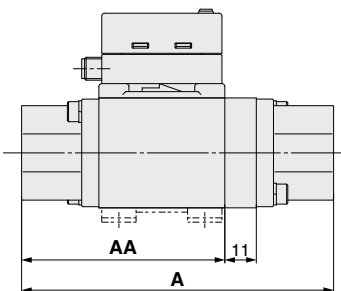

PF3W511-□-□T

Remote sensor unit: With temperature sensor

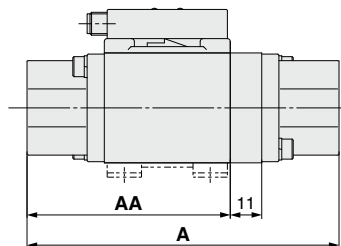

Model	[mm]	
	A	AA
PF3W711/511-□-□T	135	92
PF3W721-□-□T	115	74
PF3W721-F12-□T	119	76
PF3W721-F14-□T	123	78

PF3W-Z/L Series

Dimensions

PF3W704S(-L)/720S(-L)/740S(-L)
 Integrated display: With flow adjustment valve

PF3W504S/520S/540S
 Remote sensor unit: With flow adjustment valve

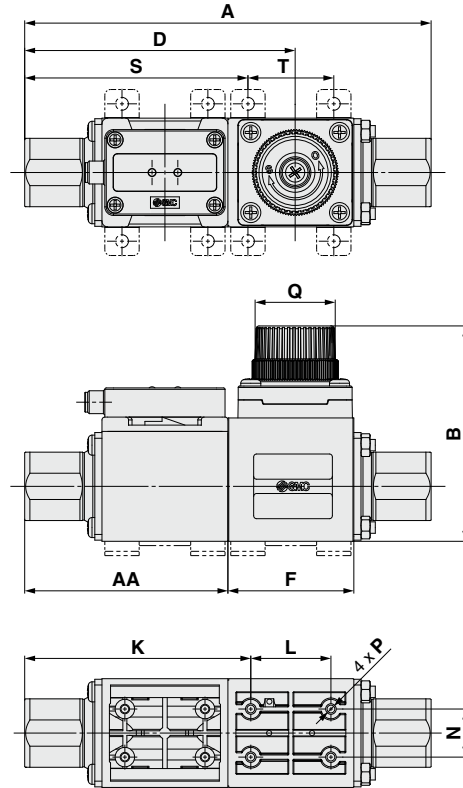
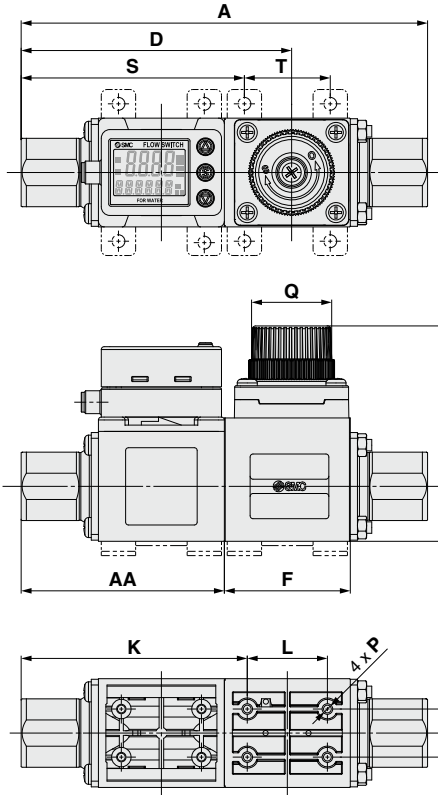

[mm]

Model	A	AA	B	D	F	K	L	N	P	Q	Number of Q rotations	Bracket dimensions	
												S	T
PF3W704S(-L)/504S	104	50	63.6 (Max. 68.6)	70.2	34	58.5	18	13.6	ø2.7 depth 10	ø19	6	56.5	22
PF3W720S(-L)/520S	112	54	63.6 (Max. 68.6)	74.2	34	62.5	18	13.6	ø2.7 depth 10	ø19	6	60.5	22
PF3W740S(-L)/540S	142	71	75.25 (Max. 81)	94.5	44	79.0	28	16.8	ø2.7 depth 10	ø28	7	78.0	30

Dimensions

PF3W704S/720S/740S-□-□T

Integrated display: With temperature sensor and flow adjustment valve

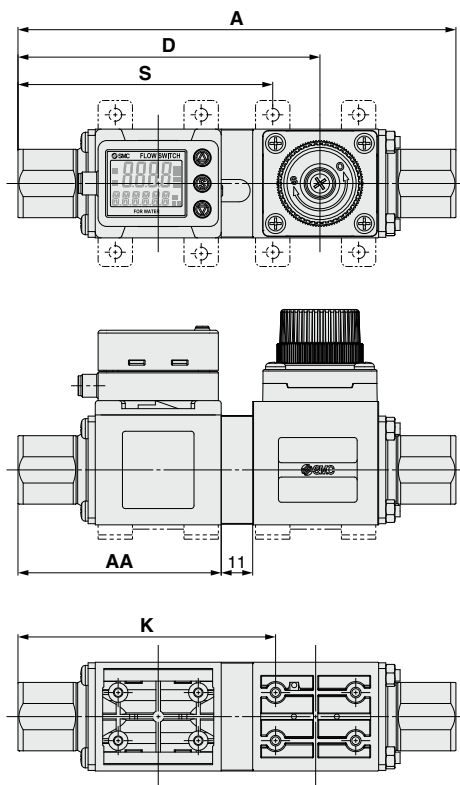

PF3W504S/520S/540S-□-□T

Remote sensor unit: With temperature sensor and flow adjustment valve

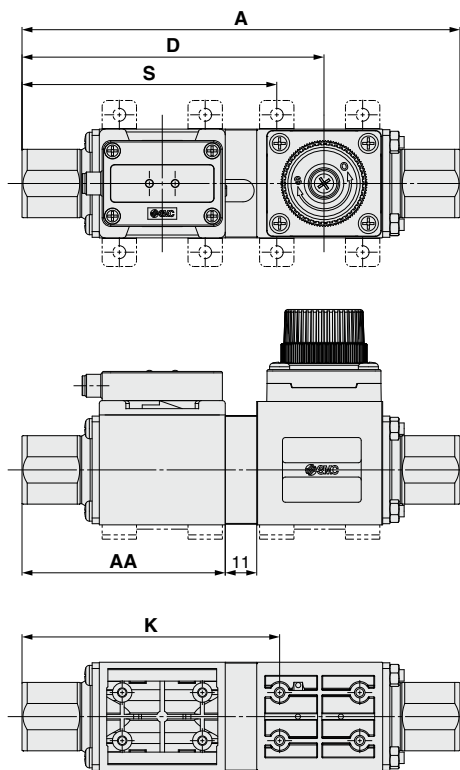

[mm]					
Model	A	AA	D	K	S
PF3W704S/504S-□-□T	115	50	81.2	69.5	67.5
PF3W720S/520S-□-□T	123	54	85.2	73.5	71.5
PF3W740S/540S-□-□T	153	71	105.5	90.0	89.0

ZS-40-A

Lead wire with M8 connector

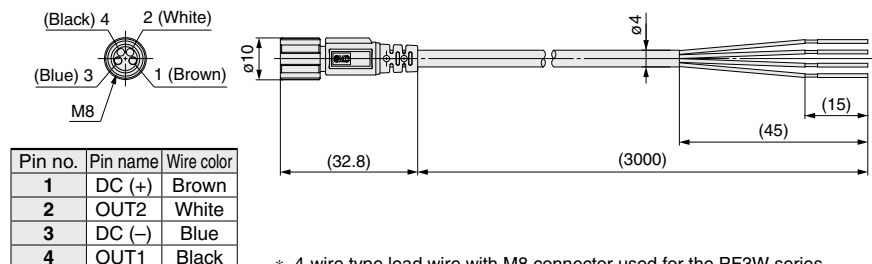

Lead Wire Specifications

Conductor	Nominal cross section	AWG 23
	O.D.	Approx. 0.7 mm
Insulator	Material	Heat-resistant PVC
	O.D.	Approx. 1.1 mm
Sheath	Material	Heat- and oil-resistant PVC
	Finished O.D.	ø4

- * 4-wire type lead wire with M8 connector used for the PF3W series
- * For wiring, refer to the Operation Manual on the SMC website.



How to Order

PF3W 30 A - **M V C**

Type

3 Remote monitor unit

For remote sensor units, select the analog output 1 to 5 V type.
Applicable sensors: PF3W5□□-□□-1(T)

Output specification

Symbol	OUT1	OUT2
A	NPN	NPN
B	PNP	PNP
C	NPN	Analog 1 to 5 V
D	NPN	Analog 4 to 20 mA
E	PNP	Analog 1 to 5 V
F	PNP	Analog 4 to 20 mA
G	NPN	External input
H	PNP	External input
J	Analog 1 to 5 V	Analog 1 to 5 V
K	Analog 4 to 20 mA	Analog 4 to 20 mA

In combination with remote sensor unit with temperature sensor, only OUT2 can be set for temperature sensor output.

Lead wire

Nil	With power supply/output connection lead wire (2 m)
N	Without power supply/output connection lead wire

The lead wire does not come connected, but it is shipped together with the product.

Remote monitor unit/Unit specification

Symbol	Instantaneous flow	Accumulated flow	Temperature
M	L/min	L	°C
G	gal/min	gal	°C
F	gal/min	gal	°F
J	L/min	L	°F

* Under the New Measurement Act, units other than SI (symbol "M") cannot be used in Japan.

* G, F, J: Made to order

Reference: 1 [L/min] ↔ 0.2642 [gal/min]
1 [gal/min] ↔ 3.785 [L/min]
°F = 9/5°C + 32

Calibration certificate (Only flow monitor)

Nil	None
A	With calibration certificate

* The certificate is written in both Japanese and English.

Option 2

Nil	None
C	Sensor connector (1 pc.)

The connector does not come connected, but it is shipped together with the product.

Option 1

Nil	None
T	Panel mount adapter
V	Front protective cover + Panel mount adapter

Options/Part Nos.

When only optional parts are required, order with the part numbers listed below.

Description	Part no.	Note
Panel mount adapter	ZS-26-B	With waterproof seal and screws
Front protective cover + Panel mount adapter	ZS-26-C	With waterproof seal and screws
Front protective cover only	ZS-26-01	Separately order panel mount adapter, etc.
Power supply/output connection lead wire	ZS-40-W	Lead wire length: 2 m
Sensor connector (e-con)	ZS-28-CA-4	1 pc.
Lead wire with connector for copying	ZS-40-Y	A maximum of 10 remote units can be connected.

For flow switch precautions and specific product precautions, refer to the Operation Manual on the SMC website.

Specifications

Model	PF3W30□			
Display flow range	0.35 to 4.50 L/min (Flow under 0.35 L/min is displayed as "0.00")	1.7 to 18.0 L/min (Flow under 1.7 L/min is displayed as "0.0")	3.5 to 45.0 L/min (Flow under 3.5 L/min is displayed as "0.0")	7 to 112 L/min (Flow under 7 L/min is displayed as "0")
Set flow range	0.35 to 4.50 L/min	1.7 to 18.0 L/min	3.5 to 45.0 L/min	7 to 112 L/min
Smallest settable increment	0.01 L/min	0.1 L/min		1 L/min
Conversion of accumulated pulse	0.05 L/pulse	0.1 L/pulse	0.5 L/pulse	1 L/pulse
Display unit	Instantaneous flow: L/min, Accumulated flow: L			
Accuracy	Display value: ±0.5% F.S. Analog output: ±0.5% F.S.			
Repeatability	±0.5% F.S.			
Temperature characteristics	±0.5% F.S. (25°C standard)			
Accumulated flow range*1	99999999.9 L		999999999 L	
	By 0.1 L	By 0.5 L	By 1 L	
Switch output	NPN or PNP open collector output			
Max. load current	80 mA			
Max. applied voltage	28 VDC			
Internal voltage drop	NPN: 1 V or less (at load current of 80 mA) PNP: 1.5 V or less (at load current of 80 mA)			
Response time*2	1 s/2 s			
Output protection	Short-circuit protection			
Output mode	Select from Hysteresis, Window comparator, Accumulated output, or Accumulated pulse output modes.			
Flow rate mode	Select from Hysteresis mode or Window comparator mode.			
Temperature mode				
Response time*3	1 s/2 s (linked with the switch output)			
Analog output Voltage output	Voltage output: 1 to 5 V Output impedance: 1 kΩ			
Current output	Output current: 4 to 20 mA Max. load impedance: 300 Ω for 12 VDC, 600 Ω for 24 VDC			
Hysteresis	Variable			
External input	Voltage free input: 0.4 V or less (Reed or Solid state), input for 30 ms or longer			
Input/output	Input for copy mode			
Display method	2-screen display (Main screen: 4-digit, 7-segment, 2-color, Red/Green Sub screen: 6-digit, 11-segment, White), Display values updated 5 times per second			
Indicator light	Output 1, Output 2: Orange			
Power supply voltage	12 to 24 VDC ±10%			
Current consumption	50 mA or less			
Connection	Power supply output 5P connector, sensor connection 4P connector (e-con)			
Environmental resistance Enclosure	IP40 (Only front face of the panel is IP65 when panel mount adapter and waterproof seal of optional parts are used.)			
Operating temperature range	0 to 50°C (No freezing or condensation)			
Operating humidity range	Operation, Storage: 35 to 85% R.H. (No condensation)			
Withstand voltage	1000 VAC for 1 minute between terminals and housing			
Insulation resistance	50 MΩ or more (500 VDC measured via megohmmeter) between terminals and housing			
Standards and regulations	CE marking (EMC directive/RoHS directive), UL (CSA)			
Weight Without power supply/output connection lead wire	50 g			
With power supply/output connection lead wire	100 g			

*1 Cleared when the power supply is turned off. The hold function can be selected. (Intervals of 2 or 5 minutes can be selected.)

If the 5-minute interval is selected, the life of the memory element (electronic parts) is limited to 1 million times. (If energized for 24 hours, life is calculated as 5 minutes x 1 million = 5 million minutes = about 9.5 years.) Therefore, if using the hold function, calculate the memory life for your operating conditions, and use within this life.

*2 The response time when the set value is 90% in relation to the step input (The response time is 7 s when it is output by the temperature sensor.)

*3 The response time until the set value reaches 90% in relation to the step input (The response time is 7 s when it is analog output by the temperature sensor.)

* Products with tiny scratches, marks, or display color or brightness variations which do not affect the performance of the product are verified as conforming products.

Temperature Sensor Specifications

Rated temperature range	0 to 100°C*1
Set/Display temperature range	-10 to 110°C
Smallest settable increment	1°C
Display unit	°C
Analog output accuracy	±3% F.S.
Response time	7 s*2
Ambient temperature characteristics	±5% F.S.

*1 The rated temperature range refers solely to that of the temperature sensor. The fluid temperature range specification of the flow switch as a whole is 0 to 90°C.

*2 The response time refers solely to that of the temperature sensor.

The output related to the temperature sensor is OUT2 only.

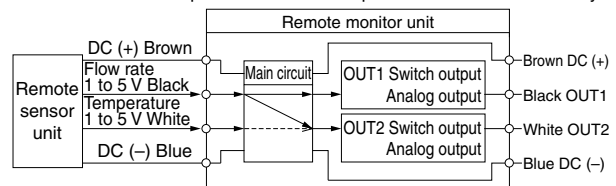

The OUT2 can be selected from either the output for temperature or flow rate by button operation.

Analog Output

Flow rate/Analog output

	A	B		C	
		04/20/40	11		21
Voltage output	1 V	1.5 V	1.4 V	1.5 V	5 V
Current output	4 mA	6 mA	5.6 mA	5.9 mA	20 mA

The values of B vary according to the range.

Model	Flow rate [L/min]	
	Minimum	Maximum
PF3W504	0.5	4
PF3W520	2	16
PF3W540	5	40
PF3W511	10	100

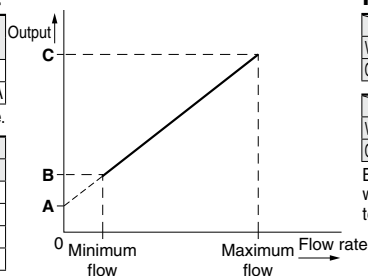

Fluid temperature/Analog output

	A	B
Current output	2.4 mA	4 mA

	C	D
Current output	20 mA	21.6 mA

Be sure to use in combination with remote sensor unit with temperature sensor.

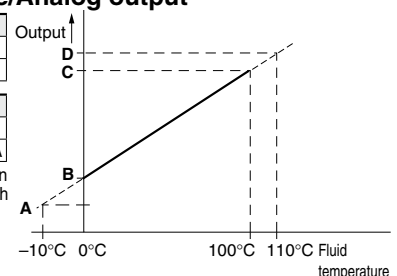

PF3W3 Series

Internal Circuits and Wiring Examples

-A NPN (2 outputs)

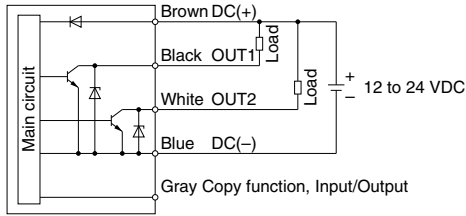

-G NPN + External input

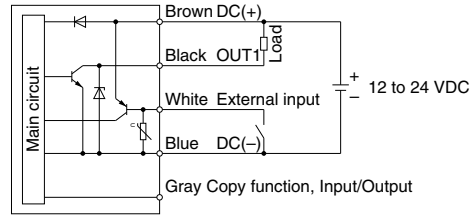

-B PNP (2 outputs)

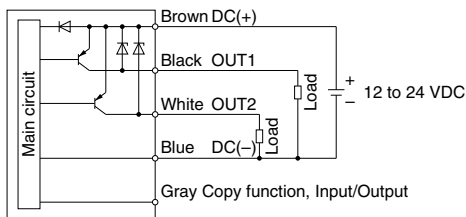

-H PNP + External input

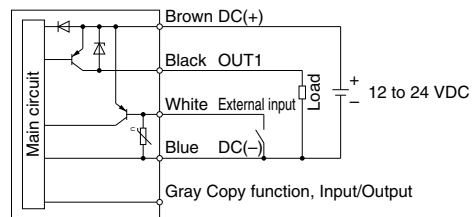

-C/D C: NPN + Analog voltage output D: NPN + Analog current output

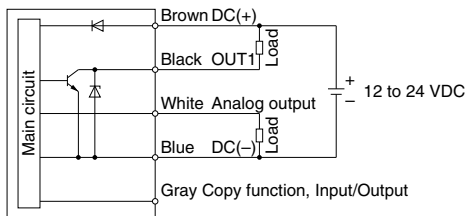

-J/K J: Analog voltage output K: Analog current output

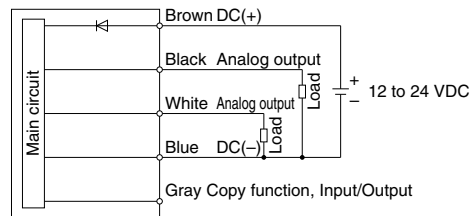

-E/F E: PNP + Analog voltage output F: PNP + Analog current output

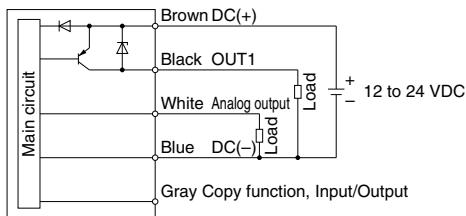

Accumulated pulse output wiring examples

-A/C/D/G A: NPN (2 outputs) C, D: NPN + Analog output G: NPN + External input

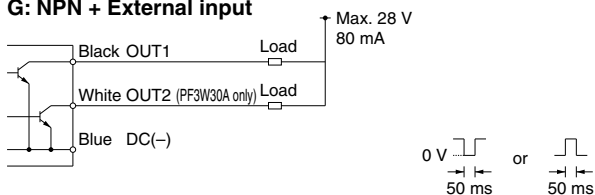

-B/E/F/H B: PNP (2 outputs) E, F: PNP + Analog output G: PNP + External input

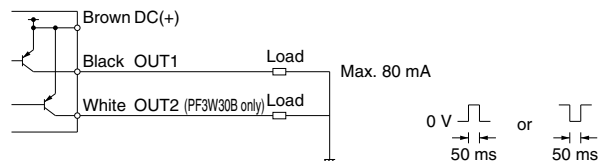

Dimensions

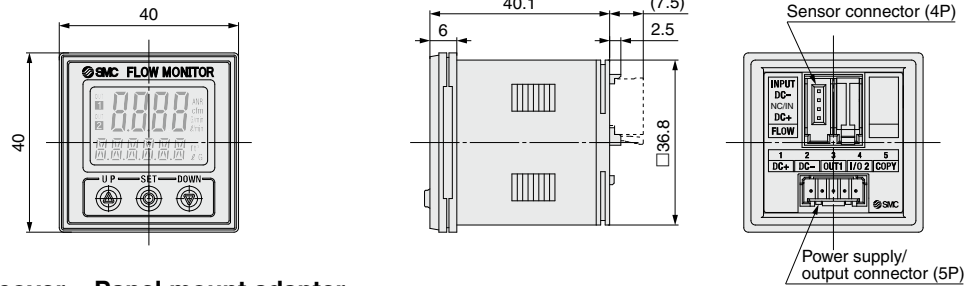

Front protective cover + Panel mount adapter

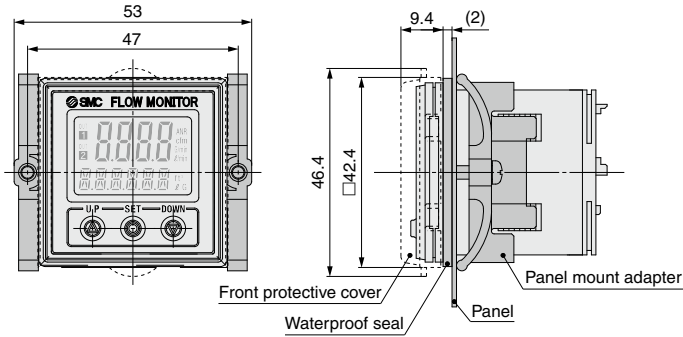

Panel fitting dimensions

Applicable panel thickness:
 0.5 to 8 mm (Without waterproof seal)
 0.5 to 6 mm (With waterproof seal)

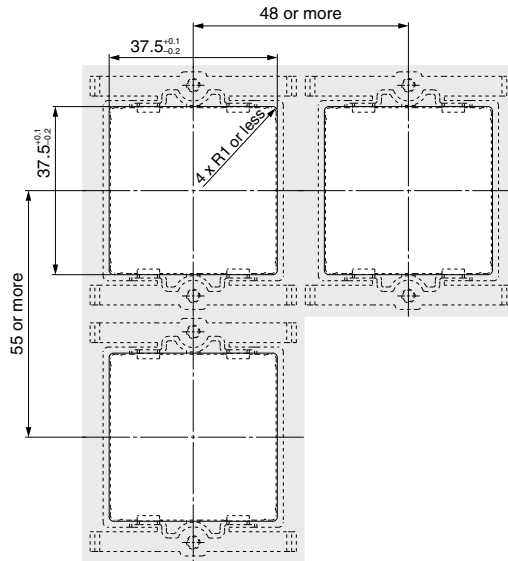

Sensor connector

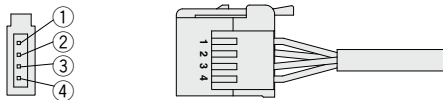

Pin no.	Terminal	Connector no.	Lead wire color*1
①	DC (+)	1	Brown
②	N.C./IN	2	White (Not used/Temperature sensor 1 to 5 V input)
③	DC (-)	3	Blue
④	INPUT	4	Black (Flow rate sensor 1 to 5 V input)

*1 When using the lead wire with M8 connector included with the PF3W5 series

Power supply/output connection lead wire

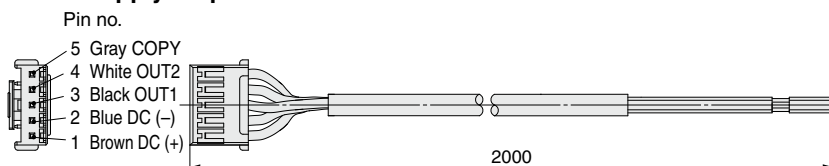

Lead Wire Specifications

Conductor	Nominal cross section	
	O.D.	AWG 26
Insulator	O.D.	Approx. 0.5 mm
	Material	Cross-linked vinyl
Sheath	O.D.	Approx. 1.0 mm
	Color	Brown, Blue, Black, White, Gray
Material	Oil- and heat-resistant vinyl	
Finished O.D.	ø3.5	

* For wiring, refer to the Operation Manual on the SMC website

PF3W-Z/L Series

Function Details

Integrated Display (PF3W7-Z Series) / IO-Link Compatible (PF3W7-L Series)

Delay time setting (PF3W7-L series only)

The time from when the instantaneous flow reaches the set value to when the switch output operates can be set. Setting the delay time can prevent the switch output from chattering.

The total switching time is the switch operation time and the set delay time. (Default setting: 0 s)

0.00 s
0.05 to 0.1 s (increment of 0.01 s)
0.1 to 1.0 s (increment of 0.1 s)
1 to 10 s (increment of 1 s)
20 s
30 s
40 s
50 s
60 s

Output operation

The output operation can be selected from the following: Output (hysteresis mode and window comparator mode) corresponding to instantaneous flow rate, output corresponding to accumulated flow, or accumulated pulse output.

* At the time of shipment from the factory, it is set to hysteresis mode and normal output.

Display color

The display color can be selected for each output condition. The selection of the display color provides visual identification of abnormal values.

Green for ON, Red for OFF
Red for ON, Green for OFF
Red all the time
Green all the time

Response time (Digital filter)

The response time (digital filter) can be set to suit the application. Setting the response time (digital filter) can reduce chattering of the switch output and flickering of the analog output and the display. The response time indicates when the set value is 90% in relation to the step input.

* The temperature sensor output is fixed to 7 s.

Response time (Digital filter)	Applicable model	
	Integrated display PF3W7-Z series	IO-Link compatible PF3W7-L series
0.5	●	●
1.0 (Default)	●	●
2.0	●	●
5.0	—	●
10.0	—	●
15.0	—	●
20.0	—	●
30.0	—	●

External input function (PF3W7-Z series only)

This function can be used only when the optional external input is present. The accumulated flow, peak value, and bottom value can be reset remotely.

Accumulated value external reset: A function to reset the accumulated flow value when an external input signal is applied.

In accumulated increment mode, the accumulated value will reset to and increase from zero.

In accumulated decrement mode, the accumulated value will reset to and decrease from the set value.

* When the accumulated value is stored to memory, every time the accumulated value external reset is activated, the memory (EEPROM) will be accessed. Take the life time of the memory device into consideration before using this function.

Peak/Bottom value reset: Peak and bottom value are reset.

Forced output function

The output is turned on/off in a fixed state when starting the system or during maintenance. This enables the confirmation of wiring and prevents system errors due to unexpected output.

For the analog output type, when ON the output will be 5 V or 20 mA, and when OFF, it will be 1 V or 4 mA.

For IO-Link compatible PF3W7-L series. Diagnostic bit (error, flow rate, and temperature), process data (PD) flow, and temperature measurement can be checked.

* Also, an increase or decrease of the flow and temperature will not change the on/off status of the output while the forced output function is activated.

Accumulated value hold

The accumulated value is not cleared even when the power supply is turned off.

The accumulated value is memorized every 2 or 5 minutes during measurement and continues from the last memorized value when the power supply is turned on again.

The maximum writable limit of the memory device is 1 million times for PF3W7-Z and 3.7 million times for PF3W7-L, which should be taken into consideration.

Display

Display layout for PF3W7-Z series and PF3W7-L series is different.

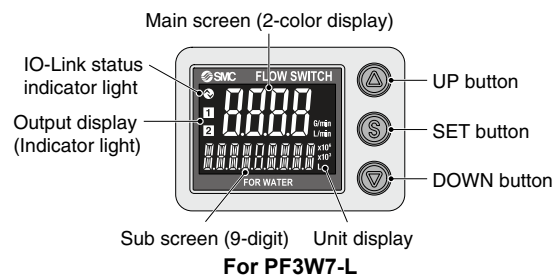
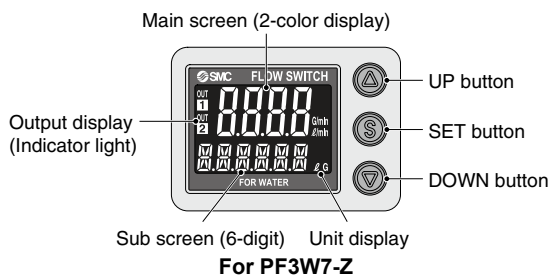

Power-saving mode

The display can be turned off to reduce power consumption. In power-saving mode, only decimal points blink. If any button is pressed during power-saving mode, the display is recovered for 30 seconds to check the flow, etc.

Setting of security code

The user can select whether a security code must be entered to release the key lock. At the time of shipment from the factory, it is set such that a security code is not required.

Peak/Bottom value display

The maximum (minimum) flow rate is detected and updated from when the power supply is turned on. In peak (bottom) value display mode, this maximum (minimum) flow rate is displayed.

Key-lock function

Prevents operation errors such as accidentally changing setting values

Integrated Display (PF3W7-Z Series) / IO-Link Compatible (PF3W7-L Series)

■ **Analog output free range function (PF3W7-Z series only)**

This function allows a flow that generates an output of 5 V or 20 mA to be changed. (This function is not available for the analog output to the temperature.) This function is available if the analog output type is used. The value can be changed between 10% of the maximum value of the rated flow and the maximum value of the display range.

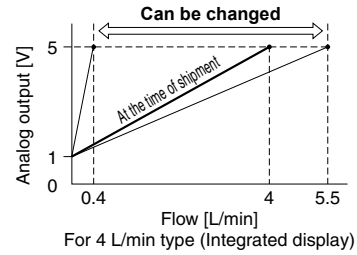

■ **Error display function**

When an error or abnormality arises, the location and contents are displayed.

Display	Description	Contents	Action	Applicable model	
				Integrated display PF3W7 series	IO-Link compatible PF3W7-L series
Er 1	OUT1 over current error	The switch output (OUT1) load current of 80 mA or more flows.	Turn the power OFF and remove the cause of the over current. Then turn the power ON again.	●	●
Er 2	OUT2 over current error	The switch output (OUT2) load current of 80 mA or more flows.	Turn the power OFF and remove the cause of the over current. Then turn the power ON again.	●	●
HHH	Instantaneous flow error	The flow has exceeded the upper limit of the display flow range.	Decrease the flow rate.	●	●
999999999 (Alternately displays [999] and [999999])	Accumulated flow error	The accumulated flow has exceeded the accumulated flow range.	Reset the accumulated flow.	●	—
999999 (Flashing)	Accumulated flow error	The accumulated flow has exceeded the accumulated flow range.	Reset the accumulated flow.	—	●
c HHH	Over upper limit of temperature	Fluid temperature exceeds 110°C.	Lower the fluid temperature.	●	●
c LLL	Under lower limit of temperature	Fluid temperature is under -10°C.	Raise the fluid temperature.	●	●
Er 0	System error	An internal data error has occurred.	Turn the power OFF and turn it ON again.	●	●
Er 4					
Er 6					
Er 8					
Er 7	System error	An internal data error has occurred.	Turn the power OFF and turn it ON again.	—	●
Er 40					
Er 12	Temperature sensor failure	Temperature sensor may be damaged.	Turn the power OFF and turn it ON again.	●	●
Er 15	Version does not match	The IO-Link version does not match that of the base. The base uses version 1.0.	Ensure that the base IO-Link version matches the device version.	—	●

If the error cannot be solved after the instructions above are performed, please contact SMC for investigation.

PF3W-Z/L Series

Remote Sensor Unit (PF3W5-Z Series)

■ POWER indicator function

It is possible to check whether power supply is reaching the product. When power is supplied to the product, the indicator lights up green.

■ FLOW indicator function

Status of the flow rate can be checked visually. When the flow rate increases, the green lamp blinks faster. When below the measurable lower limit of flow rate, the lamp turns off, when above the measurable upper limit of flow rate, red lamp turns on.

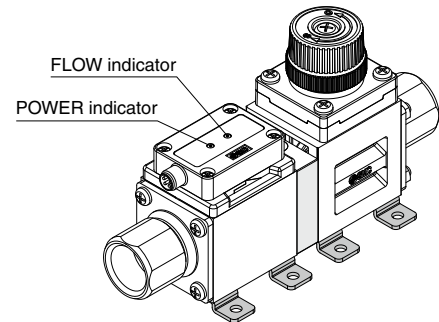

■ Error display function

When an error or abnormality arises, the location and contents are displayed.

LED display	Description	Contents	Action
	Over upper limit of flow rate	Flow is approximately 110% or more of the rated flow.	Decrease the flow rate.
	Temperature measurement range error	Fluid temperature is either under -10°C or over 110°C .	Adjust the fluid temperature within the measurable temperature range.
	Over upper limit of flow rate and temperature measurement range error	Refer to above.	Refer to above.

LED display	Description	Contents	Action
	System error	Internal data error or other errors occur.	Turn the power off and then on again. If the error cannot be rectified, please contact SMC for investigation.
		Temperature sensor may be damaged.	

If the error cannot be solved after the above instructions are performed, please contact SMC for investigation.

Safety Instructions

These safety instructions are intended to prevent hazardous situations and/or equipment damage. These instructions indicate the level of potential hazard with the labels of “Caution,” “Warning” or “Danger.” They are all important notes for safety and must be followed in addition to International Standards (ISO/IEC)*1), and other safety regulations.

 **Caution:** Caution indicates a hazard with a low level of risk which, if not avoided, could result in minor or moderate injury.

 **Warning:** Warning indicates a hazard with a medium level of risk which, if not avoided, could result in death or serious injury.

 **Danger :** Danger indicates a hazard with a high level of risk which, if not avoided, will result in death or serious injury.

*1) ISO 4414: Pneumatic fluid power – General rules relating to systems.
ISO 4413: Hydraulic fluid power – General rules relating to systems.
IEC 60204-1: Safety of machinery – Electrical equipment of machines.
(Part 1: General requirements)
ISO 10218-1: Manipulating industrial robots – Safety.
etc.

Warning

1. The compatibility of the product is the responsibility of the person who designs the equipment or decides its specifications.

Since the product specified here is used under various operating conditions, its compatibility with specific equipment must be decided by the person who designs the equipment or decides its specifications based on necessary analysis and test results. The expected performance and safety assurance of the equipment will be the responsibility of the person who has determined its compatibility with the product. This person should also continuously review all specifications of the product referring to its latest catalog information, with a view to giving due consideration to any possibility of equipment failure when configuring the equipment.

2. Only personnel with appropriate training should operate machinery and equipment.

The product specified here may become unsafe if handled incorrectly. The assembly, operation and maintenance of machines or equipment including our products must be performed by an operator who is appropriately trained and experienced.

3. Do not service or attempt to remove product and machinery/equipment until safety is confirmed.

1. The inspection and maintenance of machinery/equipment should only be performed after measures to prevent falling or runaway of the driven objects have been confirmed.
2. When the product is to be removed, confirm that the safety measures as mentioned above are implemented and the power from any appropriate source is cut, and read and understand the specific product precautions of all relevant products carefully.
3. Before machinery/equipment is restarted, take measures to prevent unexpected operation and malfunction.

4. Contact SMC beforehand and take special consideration of safety measures if the product is to be used in any of the following conditions.

1. Conditions and environments outside of the given specifications, or use outdoors or in a place exposed to direct sunlight.
2. Installation on equipment in conjunction with atomic energy, railways, air navigation, space, shipping, vehicles, military, medical treatment, combustion and recreation, or equipment in contact with food and beverages, emergency stop circuits, clutch and brake circuits in press applications, safety equipment or other applications unsuitable for the standard specifications described in the product catalog.
3. An application which could have negative effects on people, property, or animals requiring special safety analysis.
4. Use in an interlock circuit, which requires the provision of double interlock for possible failure by using a mechanical protective function, and periodical checks to confirm proper operation.

Caution

1. The product is provided for use in manufacturing industries.

The product herein described is basically provided for peaceful use in manufacturing industries.
If considering using the product in other industries, consult SMC beforehand and exchange specifications or a contract if necessary.
If anything is unclear, contact your nearest sales branch.

Limited warranty and Disclaimer/ Compliance Requirements

The product used is subject to the following “Limited warranty and Disclaimer” and “Compliance Requirements”.

Read and accept them before using the product.

Limited warranty and Disclaimer

1. The warranty period of the product is 1 year in service or 1.5 years after the product is delivered, whichever is first.*2)
Also, the product may have specified durability, running distance or replacement parts. Please consult your nearest sales branch.
2. For any failure or damage reported within the warranty period which is clearly our responsibility, a replacement product or necessary parts will be provided.
This limited warranty applies only to our product independently, and not to any other damage incurred due to the failure of the product.
3. Prior to using SMC products, please read and understand the warranty terms and disclaimers noted in the specified catalog for the particular products.

*2) Vacuum pads are excluded from this 1 year warranty.

A vacuum pad is a consumable part, so it is warranted for a year after it is delivered.
Also, even within the warranty period, the wear of a product due to the use of the vacuum pad or failure due to the deterioration of rubber material are not covered by the limited warranty.

Compliance Requirements

1. The use of SMC products with production equipment for the manufacture of weapons of mass destruction (WMD) or any other weapon is strictly prohibited.
2. The exports of SMC products or technology from one country to another are governed by the relevant security laws and regulations of the countries involved in the transaction. Prior to the shipment of a SMC product to another country, assure that all local rules governing that export are known and followed.

Caution

SMC products are not intended for use as instruments for legal metrology.

Measurement instruments that SMC manufactures or sells have not been qualified by type approval tests relevant to the metrology (measurement) laws of each country. Therefore, SMC products cannot be used for business or certification ordained by the metrology (measurement) laws of each country.

UNIT CONVERSIONS

	unit	conversion	result
length	m	x 3.28	ft
	mm	x 0.04	in
mass	g	x 0.04	oz
volume	cm ³	÷ 16.387	in ³
	L	x 61.024	in ³
speed	mm/s	÷ 25.4	in/s
pressure	MPa	x 145	psi
	kPa	÷ 6.895	psi
temperature	°C	x1.8 then add 32	°F
torque	N-m	x 0.738	ft-lb
force	N	÷ 4.448	lbf
flow	L/min	÷ 28.317	cfm

Global Manufacturing, Distribution and Service Network

Worldwide Subsidiaries

EUROPE

AUSTRIA
SMC Pneumatik GmbH (Austria)

BELGIUM
SMC Pneumatics N.V./S.A.

BULGARIA
SMC Industrial Automation Bulgaria EOOD

CROATIA
SMC Industrijska Automatika d.o.o.

CZECH REPUBLIC
SMC Industrial Automation CZ s.r.o.

DENMARK
SMC Pneumatik A/S

ESTONIA
SMC Pneumatics Estonia

FINLAND
SMC Pneumatics Finland OY

FRANCE
SMC Pneumatique S.A.

GERMANY
SMC Pneumatik GmbH

GREECE
SMC Hellas EPE

HUNGARY
SMC Hungary Ipari Automatizálási Kft.

IRELAND
SMC Pneumatics (Ireland) Ltd.

ITALY
SMC Italia S.p.A.

KAZAKHSTAN
LLP "SMC Kazakhstan"

LATVIA
SMC Pneumatics Latvia SIA

LITHUANIA
UAB "SMC Pneumatics"

NETHERLANDS
SMC Pneumatics B.V.

NORWAY
SMC Pneumatics Norway AS

POLAND
SMC Industrial Automation Polska Sp. z o.o.

ROMANIA
SMC Romania S.r.l.

RUSSIA
SMC Pneumatik LLC.

SLOVAKIA
SMC Priemyselná Automatizácia, Spol s.r.o.

SLOVENIA
SMC Pneumatika Avtomatika d.o.o.

SPAIN / PORTUGAL
SMC España, S.A.

SWEDEN
SMC Pneumatics Sweden AB

SWITZERLAND
SMC Pneumatik AG

TURKEY
SMC Pnömatik Sanayi Ticaret ve Servis A.Ş.

UK
SMC Pneumatics (U.K.) Ltd.

ASIA / OCEANIA

AUSTRALIA
SMC Pneumatics (Australia) Pty. Ltd.

CHINA
SMC (China) Co., Ltd.
SMC Pneumatics (Guangzhou) Ltd.

HONG KONG
SMC Pneumatics (Hong kong) Ltd.

INDIA
SMC Pneumatics (India) Pvt. Ltd.

INDONESIA
PT. SMC Pneumatics Indonesia

JAPAN
SMC Corporation

MALAYSIA
SMC Pneumatics (S.E.A.) Sdn. Bhd.

NEW ZEALAND
SMC Pneumatics (N.Z.) Ltd.

PHILIPPINES
Shoketsu SMC Corporation

SINGAPORE
SMC Pneumatics (S.E.A.) Pte. Ltd.

SOUTH KOREA
SMC Pneumatics Korea Co., Ltd.

TAIWAN
SMC Pneumatics (Taiwan) Co., Ltd.

THAILAND
SMC (Thailand) Ltd.

UNITED ARAB EMIRATES
SMC Pneumatics Middle East FZE

VIETNAM
SMC Pneumatics (VN) Co., Ltd

AFRICA

SOUTH AFRICA
SMC Pneumatics (South Africa) Pty Ltd

NORTH, CENTRAL & SOUTH AMERICA

ARGENTINA
SMC Argentina S.A.

BOLIVIA
SMC Pneumatics Bolivia S.R.L.

BRAZIL
SMC Pneumáticos do Brasil Ltda.

CANADA
SMC Pneumatics (Canada) Ltd.

CHILE
SMC Pneumatics (Chile) S.A.

COLOMBIA
SMC Colombia Sucursal de SMC Chile, S.A.

MEXICO
SMC Corporation (Mexico) S.A. de C.V.

PERU
SMC Corporation Peru S.A.C.

USA
SMC Corporation of America

VENEZUELA
SMC Neumatica Venezuela S.A.

U.S. & Canadian Sales Offices

- WEST**
- Austin
 - Dallas
 - Denver
 - El Paso
 - Los Angeles
 - Phoenix
 - Portland
 - San Jose
- CENTRAL**
- Chicago
 - Cincinnati
 - Cleveland
 - Detroit
 - Des Moines
 - Grand Rapids
 - Indianapolis
 - Kansas City
 - Milwaukee
 - Minneapolis
 - St. Louis

- EAST**
- Albany
 - Atlanta
 - Birmingham
 - Boston
 - Charlotte
 - Knoxville
 - Nashville
 - New Jersey
 - Rochester
 - Tampa
- CANADA**
- Vancouver
 - Toronto
 - Windsor
 - Montreal
 - Quebec City

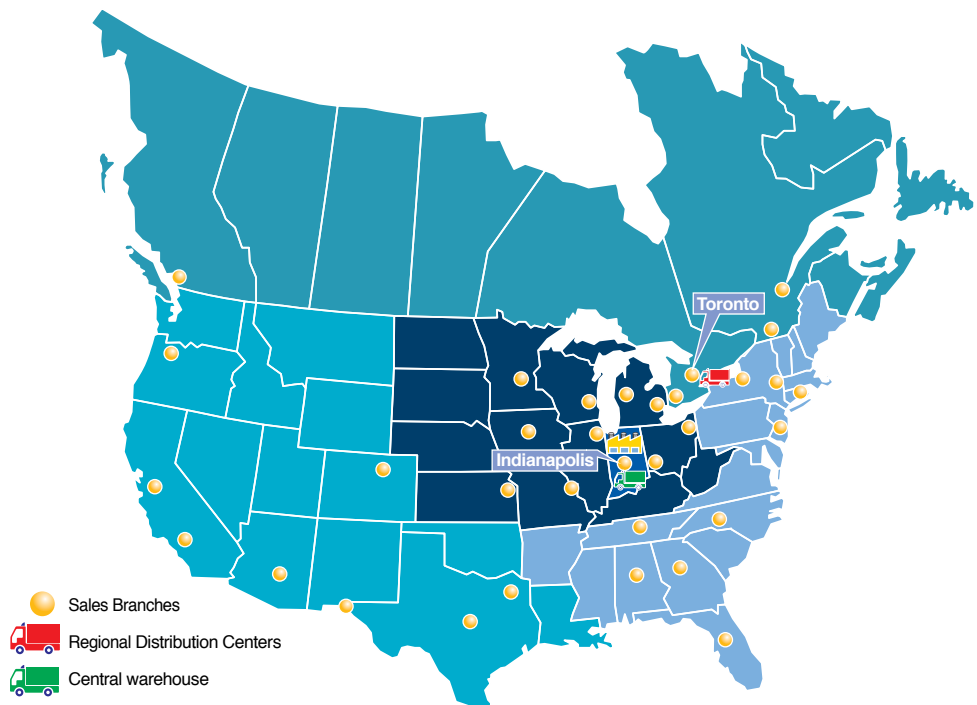

o o o o e c



s e s s c s c o s c o c o