

Direct Operated 3 Port Solenoid Valve

For Air, Water, Oil, Steam

Reduced
power consumption
(DC specification)

6 W → **4.5 w**

8 W → **7 w**

11.5 W → **10.5 w**



New
VX3 Series VX31/32/33

Solenoid valves for various fluids used in a wide variety of

Improved corrosion resistance

Special magnetic material adopted

Enclosure: Equivalent to IP65

Low-noise construction

Special construction enables to reduce the metal noise. (DC specification)

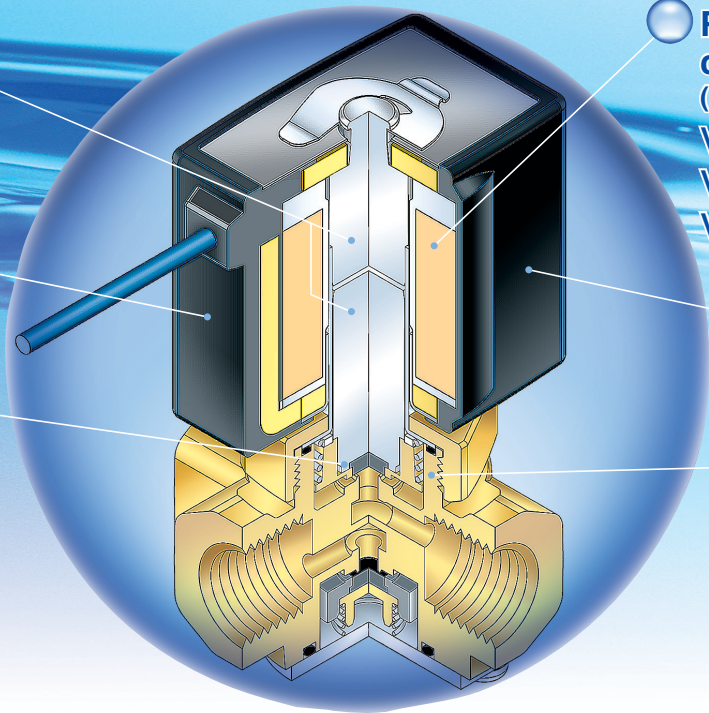

Reduced power consumption (DC specification)

VX31: 6 w → **4.5 w**

VX32: 8 w → **7 w**

VX33: 11.5 w → **10.5 w**

Flame resistance UL94V-0 conformed

Flame resistant mold coil material

Improved maintenance performance

Maintenance is performed easily due to the threaded assembly.

Direct Operated 3 Port Solenoid Valve

For Air, Water, Oil, Steam

New Series VX31/32/33

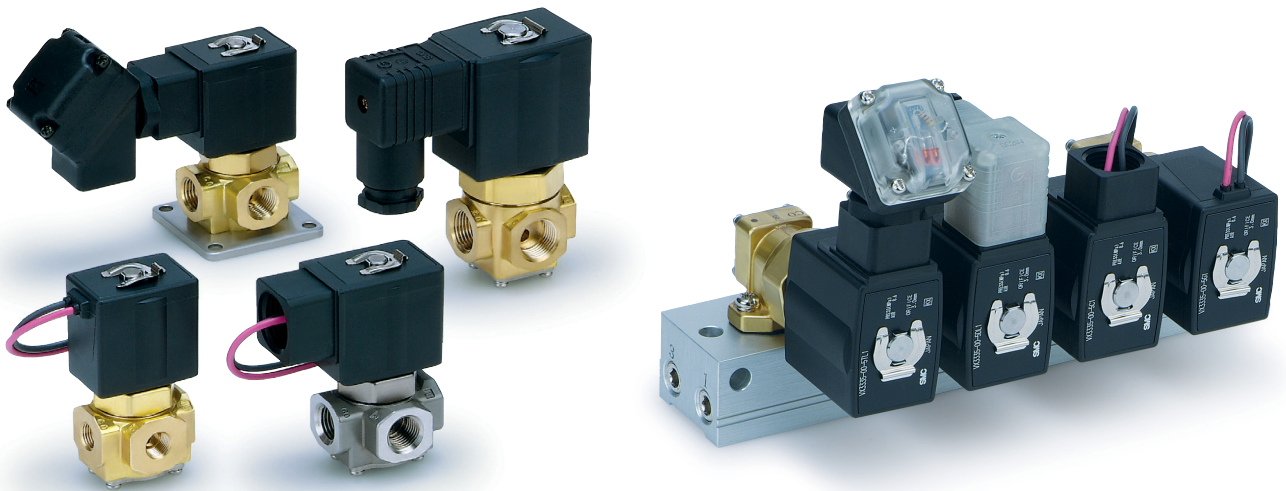

Normally Closed (N.C.) / Normally Open (N.O.) / Common (COM.)

Model	Orifice diameter				Port size	Material				Fluid
	ø1.5mm	ø2.2mm	ø3mm	ø4mm		Body	Guide pin	Seal		
VX31	●	●	●	—	1/8, 1/4	C37 Stainless steel	PPS Stainless steel	NBR	NBR	Air, Water, Oil, Steam
VX32	—	●	●	●	1/4, 3/8			FKM	FKM	
VX33	—	●	●	●	1/4, 3/8			EPDM	EPDM	

Manifold: Normally Closed (N.C.) / Normally Open (N.O.) / Common (COM.)

Model	Orifice diameter				Port size (Common SUP/EXH type)			Material			Fluid
	ø1.5mm	ø2.2mm	ø3mm	ø4mm	IN port	OUT port	EXH port	Body	Guide pin	Seal	
VVX31	●	●	●	—	1/4	1/8, 1/4	1/4	C37	PPS Stainless steel	NBR FKM EPDM	Air, Oil
VVX32	—	●	●	●							
VVX33	—	●	●	●							

applications—New **VX** Series variations

Direct Operated 2 Port

New **VX21/22/23**

For Air, Vacuum, Water, Steam, Oil

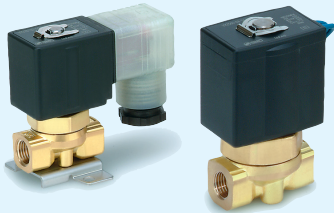

Valve type	Port size	Orifice dia. mmØ
N.C./N.O.	1/8 to 1/2	2 to 10

Pilot Operated 2 Port

New **VXD21/22/23**

For Air, Water, Oil

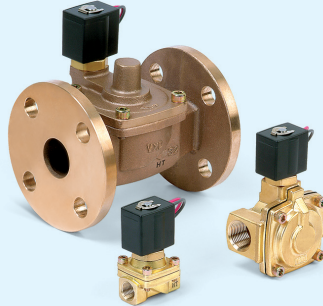

Valve type	Port size	Orifice dia. mmØ
N.C./N.O.	1/4 to 1 32A to 50A	10 to 50

Pilot Operated 2 Port for Zero Differential Pressure

New **VXZ22/23**

For Air, Vacuum, Water, Oil

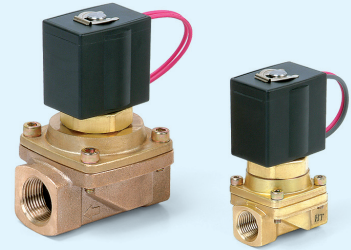

Valve type	Port size	Orifice dia. mmØ
N.C./N.O.	1/4 to 1	10 to 25

Pilot Operated 2 Port

VXP21/22/23

For Steam (Air, Water, Oil)

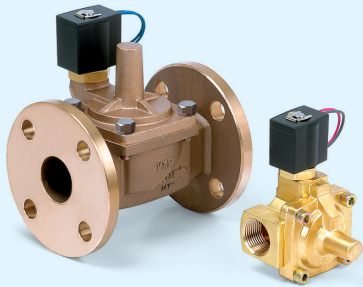

Valve type	Port size	Orifice dia. mmØ
N.C./N.O.	1/4 to 2 32A to 50A	10 to 50

Water Hammer Relief, Pilot Operated 2 Port

VXR21/22/23

For Water, Oil

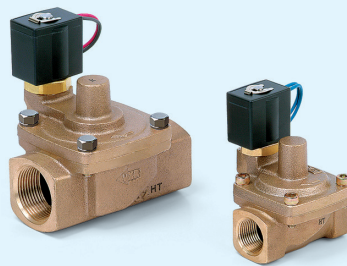

Valve type	Port size	Orifice dia. mmØ
N.C./N.O.	1/2 to 2	20 to 50

Pilot Operated 2 Port for High Pressure

VXH22

For Air, Water, Oil

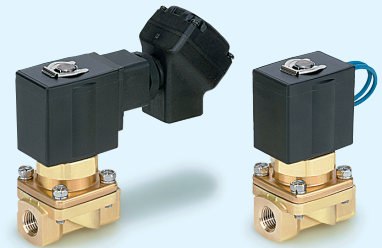

Valve type	Port size	Orifice dia. mmØ
N.C.	1/4 to 1/2	10

2 Port for Dust Collector (Solenoid type, Air Operated type)

VXF21/22, VXF21/22

For Air

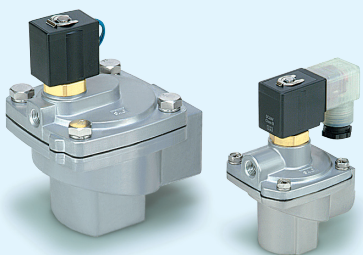

Valve type	Port size	Orifice dia. mmØ
N.C.	3/4 to 1 1/2	20 to 40

Air Operated 2/3 Port

VXA21/22, VXA31/32

For Air, Vacuum, Water, Oil

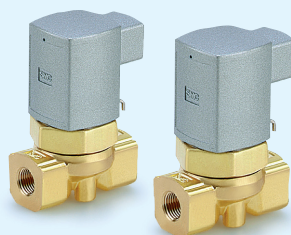

Model	Valve type	Port size	Orifice dia. mmØ
VXA21/22	N.C./N.O.	1/8 to 1/2	3 to 10
VXA31/32	COM.	1/8 to 3/8	1.5 to 4

The VX series has been renewed as the **new VX series**, with a new construction.

Direct Operated 3 Port Solenoid Valve Series VX31/32/33

For Air, Water, Oil, Steam

Specifications

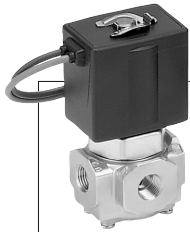

Single Unit

Valve

Normally closed (N.C.)
Normally open (N.O.)
Common (COM.)

Solenoid Coil

Coil: Class B, Class H

Rated Voltage

100 VAC, 200 VAC, 110 VAC,
220 VAC, 240 VAC, 230 VAC,
48 VAC, 24 VDC, 12 VDC

Material

Body — C37, Stainless steel
Seal — NBR, FKM, EPDM, PTFE, FFKM

Electrical Entry

- Grommet
- Conduit
- DIN terminal
- Conduit terminal



Normally Closed (N.C.) /
Normally Open (N.O.) /
Common (COM.)

Model	VX31	VX32	VX33
Orifice dia.	1.5 mmø	●	—
	2.2 mmø	●	●
	3 mmø	●	●
	4 mmø	—	●
Port size	1/8	1/4	1/4
	1/4	3/8	3/8

For Air

For Water

For Oil

For Steam

For Vacuum Pad

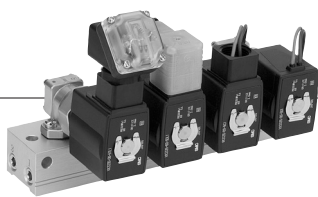

Manifold

Valve

Normally closed (N.C.)
Normally open (N.O.)
Common (COM.)

Base

Common SUP/EXH type

Solenoid Coil

Coil: Class B, Class H

Rated Voltage

100 VAC, 200 VAC, 110 VAC,
220 VAC, 240 VAC, 230 VAC,
48 VAC, 24 VDC, 12 VDC

Material

Body — C37
Base — Aluminum
Seal — NBR, FKM, EPDM

Electrical Entry

- Grommet
- Conduit
- DIN terminal
- Conduit terminal

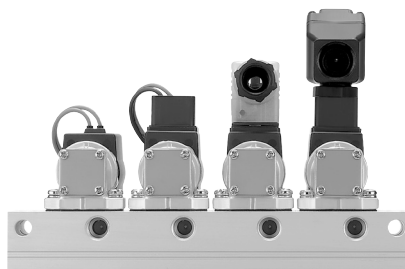

Normally Closed (N.C.) /
Normally Open (N.O.) /
Common (COM.)

Model	VX31	VX32	VX33
Orifice dia.	1.5 mmø	●	—
	2.2 mmø	●	●
	3 mmø	●	●
	4 mmø	—	●
(Common SUP/EXH type) Port size	IN port	1/4	
	OUT port	1/8, 1/4	
	EXH port	1/4	

Construction

Dimensions

Common Specifications

Standard Specifications

Valve specifications	Valve construction		Direct operated poppet
	Withstand pressure (MPa)		3.0
	Body material		C37, Stainless steel
	Seal material		NBR, FKM, EPDM, PTFE, FFKM
	Enclosure		Dusttight, Low jetproof (equivalent to IP65)*
	Environment		Location without corrosive or explosive gases
Coil specifications	Rated voltage	AC (Class B coil, Built-in full-wave rectifier type)	100 VAC, 200 VAC, 110 VAC, 220 VAC, 230 VAC, 240 VAC, 48 VAC
		AC (Class H coil)	
		DC	
	Allowable voltage fluctuation		24 VDC, 12 VDC ±10% of rated voltage
	Allowable leakage voltage	AC (Class B coil, Built-in full-wave rectifier type)	5% or less of rated voltage
		AC (Class H coil)	20% or less of rated voltage
		DC	2% or less of rated voltage
Coil insulation type		Class B, Class H	

* Electrical entry, Grommet with surge voltage suppressor (GS) has a rating of IP40.

Solenoid Coil Specifications

DC Specification

Model	Power consumption (W)	Temperature rise (C) ^{Note)}
VX31	4.5	45
VX32	7	45
VX33	10.5	60

Note) The values are for an ambient temperature of 20°C and at the rated voltage.

AC Specification (Class B coil, Built-in full-wave rectifier type)

Model	Apparent power (VA)*	Temperature rise (C) ^{Note)}
VX31	7	55
VX32	9.5	60
VX33	12	65

* There is no difference in the frequency and the inrush and energized apparent power, since a rectifying circuit is used in the AC (Class B).

Note) The values are for an ambient temperature of 20°C and at the rated voltage.

AC Specification (Class H coil)

Model	Frequency (Hz)	Apparent power (VA)		Temperature rise (C) ^{Note)}
		Inrush	Energized	
VX31	50	33	14	65
	60	28	12	60
VX32	50	65	33	100
	60	55	27	95
VX33	50	94	50	120
	60	79	41	115

Note) The values are for an ambient temperature of 20°C and at the rated voltage.

Applicable Fluid Check List

All Options (Single Unit)

VX3 ⁰₂⁴ - - 1 -

Option symbol

Fluid and application	Option symbol	Seal material		Body material/ Shading coil material ^{Note 6)}	Guide pin material	Coil insulation type ^{Note 4)}	Note
		Main valve poppet	Fixed sealant				
Air	Nil	NBR	NBR	C37	PPS	B	
	G			Stainless steel			
Medium vacuum, Non-leak, Oil-free	M ^{Note 1, 2)}	FKM	FKM	Stainless steel	PPS	B	
	V ^{Note 1, 2)}			C37			
Water	Nil	NBR	NBR	C37	PPS	B	
	G			Stainless steel			
Heated water	E	EPDM	EPDM	C37/Cu	Stainless steel	H	
	P			Stainless steel/Ag			
Oil ^{Note 3)}	A	FKM	FKM	C37	PPS	B	
	H			Stainless steel			
	D			C37/Cu	Stainless steel	H	
	N			Stainless steel/Ag			
Steam (Max.183°C)	S	FFKM	PTFE	C37/Cu	Stainless steel	H	COM. only
	Q			Stainless steel/Ag			
Copper-free, Fluoro-free ^{Note 5)}	J	EPDM	EPDM	Stainless steel	PPS	B	
	P			Stainless steel/Ag			Stainless steel
Others	B	EPDM	EPDM	C37	PPS	B	
	C						
	K ^{Note 1, 2)}	FFKM	PTFE	Stainless steel	Stainless steel	B	COM. only, Oil-free

* If using for other fluids, please consult with SMC.

All Options (Manifold)*

VX3 ¹₃⁵ - 00 - 1

Option symbol

Fluid and application	Option symbol	Seal material		Body material/ Shading coil material ^{Note 6)}	Guide pin material	Coil insulation type ^{Note 4)}
		Main valve poppet	Fixed sealant			
Air	Nil	NBR	NBR	C37	PPS	B
Medium vacuum, Non-leak, Oil-free	V ^{Note 1, 2)}	FKM	FKM	C37	PPS	B
Oil ^{Note 3)}	A	FKM	FKM	C37	PPS	B
	D			C37/Cu		
Others	B	EPDM	EPDM	C37	PPS	B
	E			C37/Cu		

* Aluminum is only available with the material for a manifold base.

* If using for other fluids, please consult with SMC.

Note 1) The leakage amount (10⁻⁶ Pa·m³/s) of "V", "M" options are values when differential pressure is 0.1 MPa.

Note 2) "V", "M" and "K" options are for oil-free treatment.

Note 3) The dynamic viscosity of the fluid must not exceed 50 mm²/s or less.

Note 4) Coil insulation type Class H: AC spec. only, Class B/AC spec.: built-in full-wave rectifier type only

Note 5) The nuts (non-welded parts) are nickel plated on the C37 material.

Note 6) There is no shading coil attached to DC spec. or Class B/AC spec.

Specifications

For Air

For Water

For Oil

For Steam

For Vacuum Pad

Construction

Dimensions

Series VX31/32/33

For Air / Single Unit

(Inert gas, Non-leak, Medium vacuum)

Model / Valve Specifications

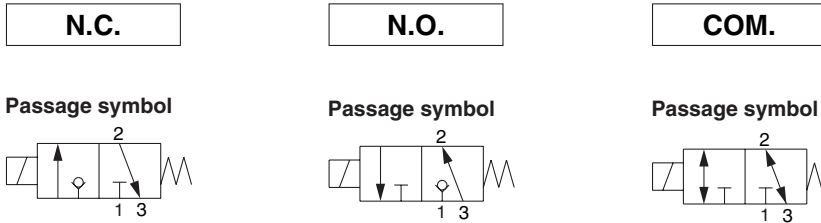

Port size	Orifice diameter (mmø)	Model	Max. operating pressure differential (MPa)			Flow characteristics			Max. system pressure (MPa)	Weight (g) ^{Note)}
			N.C.	N.O.	COM.	C[dm ³ /(s·bar)]	b	Cv		
1/8 (6A)	1.5	VX311□-01	1	1	0.7	0.29	0.32	0.08	2.0	380
	2.2	VX312□-01	0.7	0.5	0.4	0.60	0.25	0.15		
	3	VX313□-01	0.3	0.3	0.2	0.82	0.20	0.20		
1/4 (8A)	1.5	VX311□-02	1	1	0.7	0.29	0.32	0.08		
		VX312□-02	0.7	0.5	0.4	0.60	0.25	0.15		
	2.2	VX322□-02	1.2	1	0.7	0.64	0.40	0.17		
		VX332□-02	1.6	1.6	1					
	3	VX313□-02	0.3	0.3	0.2	0.82	0.20	0.20		
		VX323□-02	0.6	0.5	0.3					
	4	VX333□-02	1	0.9	0.6	1.1	0.25	0.27		
		VX324□-02	0.3	0.25	0.2					
3/8 (10A)	2.2	VX334□-02	0.5	0.4	0.3	1.6	0.20	0.38		
		VX322□-03	1.2	1	0.7					
	3	VX332□-03	1.6	1.6	1	0.64	0.40	0.17		
		VX323□-03	0.6	0.5	0.3					
	4	VX333□-03	1	0.9	0.6	1.1	0.25	0.27		
		VX324□-03	0.3	0.25	0.2					
	4	VX334□-03	0.5	0.4	0.3	1.6	0.20	0.38		
		VX334□-03	0.5	0.4	0.3					

Note) Weight of grommet type. Add 10 g for conduit, 30 g for DIN terminal, and 60 g for conduit terminal type respectively.
 Also, add 60 g for VX31□□, 80 g for VX32□□ and VX33□□ respectively for bracket option.
 • Refer to "Glossary" on page 31, for details on the max. operating pressure differential and the max. system pressure.

Fluid and Ambient Temperature

Power source	Fluid temperature (°C)		Ambient temperature (°C)
	Solenoid valve option (symbol)		
	NII, G	V, M	
AC	-10 ^{Note)} to 60	-10 ^{Note)} to 40	-20 to 60
DC	-10 ^{Note)} to 60	-10 ^{Note)} to 40	-20 to 40

Note) Dew point temperature: -10°C or less

Valve Leakage

Internal Leakage / External Leakage

Seal material	Max. operating pressure differential	Leakage rate	
		Air	Non-leak, Medium vacuum ^{Note)}
NBR, FKM	From 0 to less than 1 MPa	1 cm ³ /min or less	10 ⁻⁶ Pa·m ³ /sec or less
	1 MPa or more	2 cm ³ /min or less	

Note) The leakage amount (10⁻⁶ Pa·m³/sec) for the "V" and "M" option are values when the differential pressure is 0.1 MPa.

How to Order (Single Unit)

DC

AC/Class B coil (Built-in full-wave rectifier type)

Model
Refer to Table (1) shown below for availability.

Valve / Body type

0	N.C. / Single unit
2	N.O. / Single unit
4	COM. / Single unit

Suffix

Nil	—
Z	Oil-free spec.

Rated voltage

1	100 VAC 50/60 Hz	6	12 VDC
2	200 VAC 50/60 Hz	7	240 VAC 50/60 Hz
3	110 VAC 50/60 Hz	8	48 VAC 50/60 Hz
4	220 VAC 50/60 Hz	J	230 VAC 50/60 Hz
5	24 VDC		

* Refer to Table (3) shown below for availability.

Refer to page 23 for ordering coil only.

VX 31 1 4 [] [] - 01 [] - 5 G 1 - []

VX 31 1 4 [] [] - 01 [] - 1 GR1 - []

Orifice diameter
Refer to Table (1) shown below for availability.

Solenoid valve option
Refer to Table (2) shown below for availability.

Port size
Refer to Table (1) shown below for availability.

Thread type

Nil	Rc
T	NPTF
F	G
N	NPT

Electrical entry (AC/DC)

<p>G -Grommet</p> <p>GS-With grommet surge voltage suppressor</p> <p>T -With conduit terminal</p> <p>TS-With conduit terminal and surge voltage suppressor</p> <p>TL-With conduit terminal and light</p> <p>TZ-With conduit terminal, surge voltage suppressor and light</p>	<p>C -Conduit</p> <p>D -DIN terminal</p> <p>DS -DIN terminal with surge voltage suppressor</p> <p>DL -DIN terminal with light</p> <p>DZ -DIN terminal with surge voltage suppressor and light</p> <p>DO -For DIN terminal (without connector, gasket is included.)</p> <p><small>* DIN type is available with class B only.</small></p>
--	---

* Refer to Table (3) for available combinations between each electrical option (S, L, Z) and rated voltage.

* Surge voltage suppressor is integrated into the AC/Class B coil, as a standard.

Bracket

Nil	None
B	With bracket

* Bracket is neither mountable nor removable.

Built-in full-wave rectifier type

Table (1) Model – Orifice Diameter – Port Size

Solenoid valve model			Orifice symbol (diameter)				
Model	VX31	VX32	VX33	1 (1.5 mmø)	2 (2.2 mmø)	3 (3 mmø)	4 (4 mmø)
Port symbol (Port size)	01 (1/8)	—	—	●	●	●	—
	02 (1/4)	—	—	●	●	●	—
	—	02 (1/4)	02 (1/4)	—	●	●	●
	—	03 (3/8)	03 (3/8)	—	●	●	●

Table (2) Solenoid Valve Option

Option symbol	Seal material		Body material/ Shading coil material	Guide pin material	Coil insulation type	Note ^{Note)}
	Main valve poppet	Fixed sealant				
Nil			C37			—
G	NBR	NBR	Stainless steel	PPS	B	Non-leak (10 ⁻⁶ Pa·m ³ /sec), Medium vacuum (0.1 Pa.abs), Oil-free
M	FKM	FKM	Stainless steel			
V			C37			

Note) The leakage amount (10⁻⁶ Pa·m³/sec) for the “V” and “M” option are values when the differential pressure is 0.1 MPa.

Table (3) Rated Voltage – Electrical Option

Rated voltage			Class B		
AC/DC	Voltage symbol	Voltage	S With surge voltage suppressor	L With light	Z With light and surge voltage suppressor
AC	1	100 V	— Note)	●	— Note)
	2	200 V		●	
	3	110 V		●	
	4	220 V		●	
	7	240 V		—	
	8	48 V		—	
DC	J	230 V	—	—	
	5	24 V	●	●	●
	6	12 V	●	—	—

Note 1) Option S, Z are not available as surge voltage suppressor is integrated into the AC/Class B coil, as a standard.

* Class H coil is not available.

Specifications

For Air

For Water

For Oil

For Steam

For Vacuum Pad

Construction

Dimensions

Series VVX31/32/33

For Air /Manifold

(Inert gas, Non-leak, Medium vacuum)

Solenoid Valve for Manifold / Valve Specifications

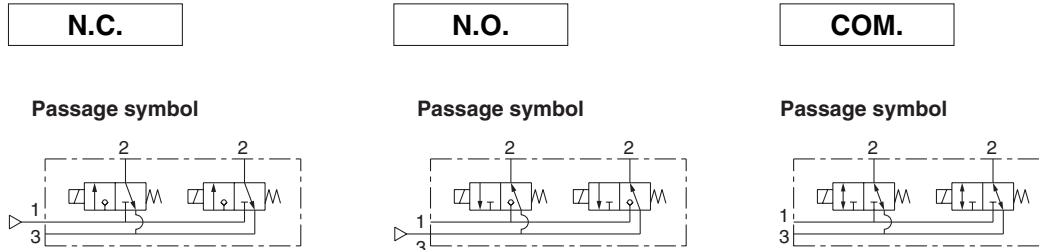

Orifice diameter (mmø)	Model	Max. operating pressure differential (MPa)			Flow characteristics			Max. system pressure (MPa)
		N.C.	N.O.	COM.	C[dm ³ /(s·bar)]	b	Cv	
1.5	VX311□-00	1	1	0.7	0.29	0.32	0.08	2.0
2.2	VX312□-00	0.7	0.5	0.4	0.60	0.25	0.15	
	VX322□-00	1.2	1	0.7				
3	VX332□-00	1.6	1.6	1	0.64	0.40	0.17	
	VX313□-00	0.3	0.3	0.2				
	VX323□-00	0.6	0.5	0.3				
4	VX333□-00	1	0.9	0.6	1.1	0.25	0.27	
	VX324□-00	0.3	0.25	0.2				
	VX334□-00	0.5	0.4	0.3				
					1.6	0.20	0.38	

Refer to "Glossary" on page 31 for details on the max. operating pressure differential and the max. system pressure.

Fluid and Ambient Temperature

Power source	Fluid temperature (°C)		Ambient temperature (°C)
	Solenoid valve option (symbol)		
	Nil	V	
AC	-10 ^{Note)} to 60	-10 ^{Note)} to 40	-20 to 60
DC	-10 ^{Note)} to 60	-10 ^{Note)} to 40	-20 to 40

Note) Dew point temperature: -10°C or less

Valve Leakage

Internal Leakage / External Leakage

Seal material	Max. operating pressure differential	Leakage rate	
		Air	Non-leak, Medium vacuum ^{Note)}
NBR, FKM	From 0 to less than 1 MPa	1 cm ³ /min or less	10 ⁻⁶ Pa·m ³ /sec or less
	1 MPa or more	2 cm ³ /min or less	

Note) The leakage amount (10⁻⁶ Pa·m³/sec) for the "V" option are values when the differential pressure is 0.1 MPa.

How to Order (Solenoid Valve for Manifold)

DC

AC/Class B coil (Built-in full-wave rectifier type)

Model
Refer to Table (1) shown below for availability.

Valve / Body type

1	N.C. / Manifold
3	N.O. / Manifold
5	COM. / Manifold

Rated voltage

1	100 VAC 50/60 Hz	6	12 VDC
2	200 VAC 50/60 Hz	7	240 VAC 50/60 Hz
3	110 VAC 50/60 Hz	8	48 VAC 50/60 Hz
4	220 VAC 50/60 Hz	J	230 VAC 50/60 Hz
5	24 VDC		

* Refer to Table (3) shown below for availability.

Refer to page 23 for ordering coil only.

VX 31 1 1 □ □ - 00 - 5 G 1

VX 31 1 1 □ □ - 00 - 1 GR1

Orifice diameter
Refer to Table (1) shown below for availability.

Solenoid valve option
Refer to Table (2) shown below for availability.

Suffix

Nil	—
Z	Oil-free spec.

Built-in full-wave rectifier type

Electrical entry (AC/DC)

G -Grommet
GS-With grommet surge voltage suppressor

C -Conduit

T -With conduit terminal
TS-With conduit terminal and surge voltage suppressor
TL -With conduit terminal and light
TZ -With conduit terminal, surge voltage suppressor and light

D -DIN terminal
DS -DIN terminal with surge voltage suppressor
DL -DIN terminal with light
DZ -DIN terminal with surge voltage suppressor and light
DO -For DIN terminal (without connector, gasket is included.)

* DIN type is available with class B only.

Specifications

For Air

For Water

For Oil

For Steam

For Vacuum Pad

How to Order Manifold Bases

VVX31
VVX32 1 □ - 07 1
VVX33

Number of manifolds

02	2 stations
⋮	⋮
10	10 stations

Port size (Individual port)

1	Rc 1/8
2	Rc 1/4

* Common port sizes are all Rc 1/4.
* Indicating numbers shown below are for common ports.

Type	SUP port	EXH port
N.C.	1	3
N.O.	3	1

Suffix

Nil	—
Z	Oil-free spec.

Manifold base

Blanking plate part no.

For VX31 VVX31-4A-□
For VX32/33: VVX32-4A-□

Seal material

Nil	NBR
F	FKM

How to Order Manifold Assemblies (Example)

Enter the valve and blanking plate to be mounted under the manifold base part number.

Example
VVX311-05-1 1 set “*” is the symbol for mounting.
* VX3111-00-1GR1 ... 4 sets Add an “*” in front of the part numbers for solenoid valves, etc. to be mounted.
* VVX31-4A 1 set

Enter the product's part number in order, counting the 1st station from the left in the manifold arrangement, when viewing the individual port in front. The common port on the

* Refer to Table (3) for available combinations between each electrical option (S, L, Z) and rated voltage.
* Surge voltage suppressor is integrated into the AC/Class B coil, as a standard.

Table (1) Model Orifice Diameter

Solenoid valve model	Orifice symbol (diameter)			
	1 (1.5 mmø)	2 (2.2 mmø)	3 (3 mmø)	4 (4 mmø)
VX31	●	●	●	—
VX32	—	●	●	●
VX33	—	●	●	●

Table (2) Solenoid Valve Option

Option symbol	Seal material		Body material	Guide pin material	Coil insulation type	Note (Note)
	Main valve poppet	Fixed sealant				
Nil	NBR	NBR	C37	PPS	B	—
V	FKM	FKM				

* Aluminum is only available as a material for the manifold base.

Note) The leakage amount (10⁻⁶ Pa·m³/sec) for the “V” option are values when the differential pressure is 0.1 MPa.

Table (3) Rated Voltage Electrical Option

AC/DC	Rated voltage		Class B		
	Voltage symbol	Voltage	S With surge voltage suppressor	L With light	Z With light and surge voltage suppressor
AC	1	100 V	— (Note)	●	— (Note)
	2	200 V			
	3	110 V			
	4	220 V			
	7	240 V			
	8	48 V			
DC	J	230 V	—	—	—
	5	24 V	●	●	●
	6	12 V	●	—	—

* Class H coil is not available.

Note) Option S, Z are not available as surge voltage suppressor is integrated into the AC/Class B coil, as a standard.

Series VX31/32/33

For Water /Single Unit

Model / Valve Specifications

N.C.

Passage symbol

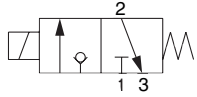

N.O.

Passage symbol

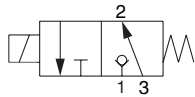

COM.

Passage symbol

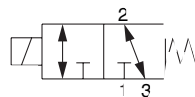

Port size	Orifice diameter (mmø)	Model	Max. operating pressure differential (MPa)			Flow characteristics		Max. system pressure (MPa)	Weight (g) ^{Note)}
			N.C.	N.O.	COM.	Av x 10 ⁻⁶ m ²	Cv converted		
1/8 (6A)	1.5	VX311□-01	1	1	0.7	1.9	0.08	2.0	380
	2.2	VX312□-01	0.7	0.5	0.4	3.8	0.16		
	3	VX313□-01	0.3	0.3	0.2	5.8	0.24		
1/4 (8A)	1.5	VX311□-02	1	1	0.7	1.9	0.08		
		VX312□-02	0.7	0.5	0.4	3.8	0.16		
		VX322□-02	1.2	1	0.7	4.6	0.19		
	VX332□-02	1.6	1.6	1					
	3	VX313□-02	0.3	0.3	0.2	5.8	0.24		
		VX323□-02	0.6	0.5	0.3				
		VX333□-02	1	0.9	0.6	7.9	0.33		
		VX324□-02	0.3	0.25	0.2				
	4	VX334□-02	0.5	0.4	0.3	12	0.50		
		VX322□-03	1.2	1	0.7				
3/8 (10A)	2.2	VX332□-03	1.6	1.6	1	4.6	0.19		
		VX323□-03	0.6	0.5	0.3				
	3	VX333□-03	1	0.9	0.6	7.9	0.33		
		VX324□-03	0.3	0.25	0.2				
	4	VX334□-03	0.5	0.4	0.3	12	0.50		
		VX324□-03	0.3	0.25	0.2				



Note) Weight of grommet type. Add 10 g for conduit, 30 g for DIN terminal, and 60 g for conduit terminal type respectively.

Also, add 60 g for VX31□□, 80 g for VX32□□ and VX33□□ respectively for bracket option.

• Refer to "Glossary" on page 31 for details on the max. operating pressure differential and the max. system pressure.

Fluid and Ambient Temperature

Power source	Fluid temperature (°C)		Ambient temperature (°C)
	Solenoid valve option (symbol)		
	N, I, G, H	E, P	
AC	1 to 60	1 to 99	-20 to 60
DC	1 to 40	—	-20 to 40



Note) With no freezing

Valve Leakage

Internal Leakage / External Leakage

Seal material	Max. operating pressure differential	Leakage rate (Water)
NBR, FKM, EPDM	From 0 to less than 1 MPa 1 MPa or more	0.1 cm ³ /min or less 0.2 cm ³ /min or less

How to Order (Single Unit)

DC, AC/Class H coil **VX 31 1 4** **01** **1 G** **1**

AC/Class B coil (Built-in full-wave rectifier type) **VX 31 1 4** **01** **1 G R1**

Bracket

Nil	None
B	With bracket

* Bracket is neither mountable nor removable.

Model Refer to Table (1) shown below for availability.

Orifice diameter Refer to Table (1) shown below for availability.

Valve / Body type

0	N.C. / Single unit
2	N.O. / Single unit
4	COM. / Single unit

Solenoid valve option Refer to Table (2) shown below for availability.

Port size Refer to Table (1) shown below for availability.

Thread type

Nil	Rc
T	NPTF
F	G
N	NPT

Rated voltage

1	100 VAC 50/60 Hz	6	12 VDC
2	200 VAC 50/60 Hz	7	240 VAC 50/60 Hz
3	110 VAC 50/60 Hz	8	48 VAC 50/60 Hz
4	220 VAC 50/60 Hz	J	230 VAC 50/60 Hz
5	24 VDC		

* Refer to Table (3) shown below for availability.

Refer to page 23 for ordering coil only.

Electrical entry

<p>G -Grommet</p> <p>GS-With grommet surge voltage suppressor</p> <p>T -With conduit terminal</p> <p>TS-With conduit terminal and surge voltage suppressor</p> <p>TL -With conduit terminal and light</p> <p>TZ-With conduit terminal, surge voltage suppressor and light</p>	<p>C -Conduit</p> <p>D -DIN terminal</p> <p>DS -DIN terminal with surge voltage suppressor</p> <p>DL -DIN terminal with light</p> <p>DZ -DIN terminal with surge voltage suppressor and light</p> <p>DO -For DIN terminal (without connector, gasket is included.)</p> <p><small>* DIN type is available with class B only.</small></p>
---	---

* Refer to Table (3) for available combinations between each electrical option (S, L, Z) and rated voltage.

* Surge voltage suppressor is integrated into the AC/Class B coil, as a standard.

Specifications

For Air

For Water

For Oil

For Steam

For Vacuum Pad

Table (1) Model Orifice Diameter Port Size

Solenoid valve model			Orifice symbol (diameter)				
Model	VX31	VX32	VX33	1 (1.5 mmø)	2 (2.2 mmø)	3 (3 mmø)	4 (4 mmø)
Port symbol (Port size)	01 (1/8)	—	—	●	●	●	—
	02 (1/4)	—	—	●	●	●	—
	—	02 (1/4)	02 (1/4)	—	●	●	●
	—	03 (3/8)	03 (3/8)	—	●	●	●

Table (2) Solenoid Valve Option

Option symbol	Seal material		Body material/ Shading coil material	Guide pin material	Coil insulation type	Note
	Main valve poppet	Fixed sealant				
Nil			C37	PPS	B	—
G	NBR	NBR	Stainless steel	Stainless steel	H	Heated water
E	EPDM	EPDM	C37/Cu	PPS	B	—
P	EPDM	EPDM	Stainless steel/Ag	PPS	B	—
H	FKM	FKM	Stainless steel	PPS	B	—

Table (3) Rated Voltage Electrical Option

Rated voltage			Class B		
AC/DC	Voltage symbol	Voltage	S With surge voltage suppressor	L With light	Z With light and surge voltage suppressor
AC	1	100 V	— Note)	●	— Note)
	2	200 V		●	
	3	110 V		●	
	4	220 V		●	
	7	240 V		—	
	8	48 V		—	
DC	J	230 V	—	—	—
	5	24 V	●	●	●
	6	12 V	●	—	—

Note) Option S, Z are not available as surge voltage suppressor is integrated into the AC/Class B coil, as a standard.

Rated voltage			Class H		
AC/DC	Voltage symbol	Voltage	S With surge voltage suppressor	L With light	Z With light and surge voltage suppressor
AC	1	100 V	●	●	●
	2	200 V	●	●	●
	3	110 V	●	●	●
	4	220 V	●	●	●
	7	240 V	●	—	—
	8	48 V	●	—	—
DC	J	230 V	●	—	—
	5	24 V	DC specification is not available.		
	6	12 V	DC specification is not available.		

Construction

Dimensions

Series VX31/32/33

For Oil /Single Unit

Model / Valve Specifications

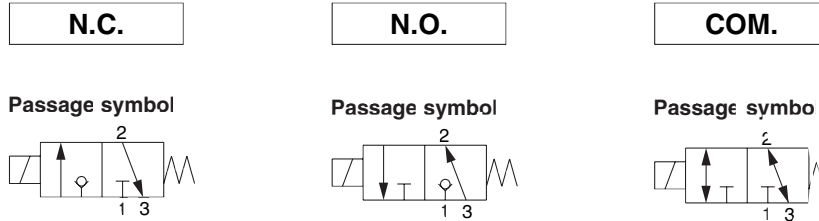

Port size	Orifice diameter (mmø)	Model	Max. operating pressure differential (MPa)			Flow characteristics		Max. system pressure (MPa)	Weight (g) ^{Note)}
			N.C.	N.O.	COM.	Av x 10 ⁻⁶ m ²	Cv converted		
1/8 (6A)	1.5	VX311□-01	1	1	0.7	1.9	0.08	380	
	2.2	VX312□-01	0.7	0.5	0.4	3.8	0.16		
	3	VX313□-01	0.3	0.3	0.2	5.8	0.24		
1/4 (8A)	1.5	VX311□-02	1	1	0.7	1.9	0.08		
		VX312□-02	0.7	0.5	0.4	3.8	0.16		
		VX322□-02	1.2	1	0.7	4.6	0.19		
	3	VX313□-02	0.3	0.3	0.2	5.8	0.24		
		VX323□-02	0.6	0.5	0.3	7.9	0.33		
		VX333□-02	1	0.9	0.6				
		4	VX324□-02	0.3	0.25	0.2	12		0.50
			VX334□-02	0.5	0.4	0.3			
3/8 (10A)	2.2	VX322□-03	1.2	1	0.7	4.6	0.19		
		VX332□-03	1.6	1.6	1	7.9	0.33		
	3	VX323□-03	0.6	0.5	0.3				
		VX333□-03	1	0.9	0.6				
		VX324□-03	0.3	0.25	0.2	12	0.50		
	4	VX334□-03	0.5	0.4	0.3				

Note) Weight of grommet type. Add 10 g for conduit, 30 g for DIN terminal, and 60 g for conduit terminal type respectively.
 Also, add 60 g for VX31□□, 80 g for VX32□□ and VX33□□ respectively for bracket option.
 • Refer to "Glossary" on page 31 for details on the max. operating pressure differential and the max. system pressure.

Fluid and Ambient Temperature

Power source	Fluid temperature (°C)		Ambient temperature (°C)
	Solenoid valve option (symbol)		
	A, H	D, N	
AC	-5 ^{Note)} to 60	-5 ^{Note)} to 120	-20 to 60
DC	-5 ^{Note)} to 40	—	-20 to 40

Note) Dynamic viscosity: 50 mm²/s or less

Valve Leakage

Internal Leakage / External Leakage

Seal material	Max. operating pressure differential	Leakage rate (Oil)
FKM	From 0 to less than 1 MPa	0.1 cm ³ /min or less
	1 MPa or more	0.2 cm ³ /min or less

How to Order (Single Unit)

DC, AC/Class H coil

AC/Class B coil (Built-in full-wave rectifier type)

Model
Refer to Table (1) shown below for availability.

Valve / Body type

0	N.C. / Single unit
2	N.O. / Single unit
4	COM. / Single unit

Suffix

Nil	—
Z	Oil-free spec.

VX 31 1 4 A [] - 01 [] - 1 G 1 - []

VX 31 1 4 A [] - 01 [] - 1 G R1 - []

Orifice diameter
Refer to Table (1) shown below for availability.

Solenoid valve option
Refer to Table (2) shown below for availability.

Port size
Refer to Table (1) shown below for availability.

Thread type

Nil	Rc
T	NPTF
F	G
N	NPT

Rated voltage

1	100 VAC 50/60 Hz	6	12 VDC
2	200 VAC 50/60 Hz	7	240 VAC 50/60 Hz
3	110 VAC 50/60 Hz	8	48 VAC 50/60 Hz
4	220 VAC 50/60 Hz	J	230 VAC 50/60 Hz
5	24 VDC		

* Refer to Table (3) shown below for availability.

Refer to page 23 for ordering coil only.

Bracket

Nil	None
B	With bracket

* Bracket is neither mountable nor removable

Built-in full-wave rectifier type

Electrical entry

G -Grommet
GS-With grommet surge voltage suppressor

C -Conduit

T -With conduit terminal
TS -With conduit terminal and surge voltage suppressor
TL -With conduit terminal and light
TZ -With conduit terminal, surge voltage suppressor and light

D -DIN terminal
DS -DIN terminal with surge voltage suppressor
DL -DIN terminal with light
DZ -DIN terminal with surge voltage suppressor and light
DO -For DIN terminal (without connector, gasket is included.)

Connector

* DIN type is available with class B only.

* Refer to Table (3) for available combinations between each electrical option (S, L, Z) and rated voltage.
* Surge voltage suppressor is integrated into the AC/Class B coil, as a standard.

Specifications

For Air

For Water

For Oil

For Steam

For Vacuum Pad

Table (1) Model Orifice Diameter Port Size

Model	Solenoid valve model			Orifice symbol (diameter)			
	VX31	VX32	VX33	1 (1.5 mmø)	2 (2.2 mmø)	3 (3 mmø)	4 (4 mmø)
Port symbol (Port size)	01 (1/8)	—	—	●	●	●	—
	02 (1/4)	—	—	●	●	●	—
	—	02 (1/4)	02 (1/4)	—	●	●	●
	—	03 (3/8)	03 (3/8)	—	●	●	●

Table (2) Solenoid Valve Option

Option symbol	Seal material		Body material/ Shading coil material	Guide pin material	Coil insulation type
	Main valve poppet	Fixed sealant			
A	FKM	FKM	C37	PPS	B
H			Stainless steel		
D			C37/Cu	Stainless steel	H
N			Stainless steel/Ag		

* The additives contained in oil are different depending on the type and manufacturers, so the durability of the seal materials will vary. For details, please consult with SMC.

Table (3) Rated Voltage Electrical Option

Rated voltage	Class B				
	S	L	Z		
AC/DC	With surge voltage suppressor	With light	With light and surge voltage suppressor		
AC	1 100 V	●	—	— (Note)	
	2 200 V	●	—	— (Note)	
	3 110 V	●	—	— (Note)	
	4 220 V	— (Note)	●	— (Note)	
	7 240 V	—	—	— (Note)	
	8 48 V	—	—	— (Note)	
DC	J 230 V	—	—	— (Note)	
	5 24 V	●	●	●	
	6 12 V	●	—	—	

Note) Option S, Z are not available as surge voltage suppressor is integrated into the AC/Class B coil, as a standard.

Rated voltage	Class H				
	S	L	Z		
AC/DC	With surge voltage suppressor	With light	With light and surge voltage suppressor		
AC	1 100 V	●	●	●	
	2 200 V	●	●	●	
	3 110 V	●	●	●	
	4 220 V	●	●	●	
	7 240 V	●	—	—	
	8 48 V	●	—	—	
DC	J 230 V	●	—	—	
	5 24 V	DC specification is not available.			
	6 12 V	DC specification is not available.			

Series VVX31/32/33

For Oil / Manifold

Solenoid Valve for Manifold / Valve Specifications

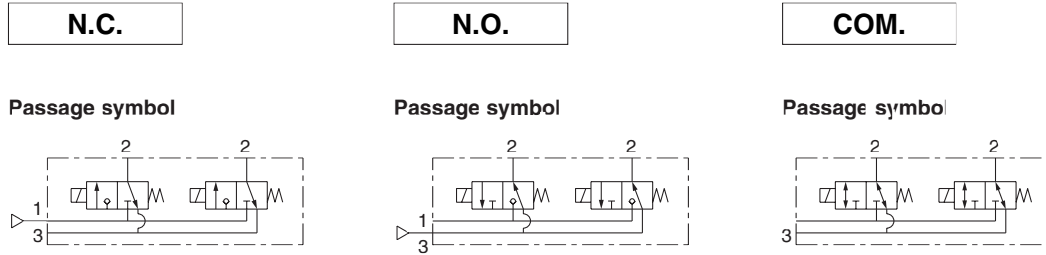

Orifice diameter (mmø)	Model	Max. operating pressure differential (MPa)			Flow characteristics		Max. system pressure (MPa)
		N.C.	N.O.	COM.	Av x 10 ⁻⁶ m ²	Cv converted	
1.5	VX311□-00	1	1	0.7	1.9	0.08	2.0
2.2	VX312□-00	0.7	0.5	0.4	3.8	0.16	
	VX322□-00	1.2	1	0.7	4.6	0.19	
	VX332□-00	1.6	1.6	1			
3	VX313□-00	0.3	0.3	0.2	5.8	0.24	
	VX323□-00	0.6	0.5	0.3	7.9	0.33	
	VX333□-00	1	0.9	0.6			
4	VX324□-00	0.3	0.25	0.2	12	0.50	
	VX334□-00	0.5	0.4	0.3			

Refer to "Glossary" on page 31 for details on the max. operating pressure differential and the max. system pressure

Fluid and Ambient Temperature

Power source	Fluid temperature (°C)		Ambient temperature (°C)
	Solenoid valve option (symbol)		
	A	D	
AC	-5 ^{Note)} to 60	-5 ^{Note)} to 120	-20 to 60
DC	-5 ^{Note)} to 40	—	-20 to 40

Note) Dynamic viscosity: 50 mm²/s or less

Valve Leakage

Internal Leakage / External Leakage

Seal material	Max. operating pressure differential	Leakage rate (Oil)
FKM	From 0 to less than 1 MPa	0.1 cm ³ /min or less
	1 MPa or more	0.2 cm ³ /min or less

How to Order (Solenoid Valve for Manifold)

DC, AC/Class H coil VX 31 1 1 A □ -00- 1 G 1

AC/Class B coil (Built-in full-wave rectifier type) VX 31 1 1 A □ -00- 1 G R1

Model Refer to Table (1) shown below for availability.

Orifice diameter Refer to Table (1) shown below for availability.

Valve / Body type

1	N.C. / Manifold
3	N.O. / Manifold
5	COM. / Manifold

Solenoid valve option Refer to Table (2) shown below for availability.

Rated voltage

1	100 VAC 50/60 Hz	6	12 VDC
2	200 VAC 50/60 Hz	7	240 VAC 50/60 Hz
3	110 VAC 50/60 Hz	8	48 VAC 50/60 Hz
4	220 VAC 50/60 Hz	J	230 VAC 50/60 Hz
5	24 VDC		

Suffix

Nil	—
Z	Oil-free spec.

* Refer to Table (3) shown below for availability.

Refer to page 23 for ordering coil only.

Electrical entry

G -Grommet
GS-With grommet surge voltage suppressor

C -Conduit

D -DIN terminal
DS -DIN terminal with surge voltage suppressor
DL -DIN terminal with light
DZ -DIN terminal with surge voltage suppressor and light
DO -For DIN terminal (without connector, gasket is included.)

T -With conduit terminal
TS -With conduit terminal and surge voltage suppressor
TL -With conduit terminal and light
TZ -With conduit terminal, surge voltage suppressor and light

How to Order Manifold Bases

VVX31
VVX32
VVX33

1 □ -07 1

Manifold base

Suffix

Nil	—
Z	Oil-free spec.

Number of manifolds

02	2 stations
⋮	⋮
10	10 stations

Port size (Individual port)

1	Rc 1/8
2	Rc 1/4

* Common port sizes are all Rc 1/4.
* Indicating numbers shown below are for common ports.

Type	SUP port	EXH port
N.C.	1	3
N.O.	3	1

Blanking plate part no.

For VX31 VVX31-4A-F

For VX32/33: VVX32-4A-F

Seal material: FKM

How to Order Manifold Assemblies (Example)

Enter the valve and blanking plate to be mounted under the manifold base part number.

Example
VVX311-05-1 1 set "*" is the symbol for mounting.
* VX3111A-00-1GR1.. 4 sets Add an "*" in front of the part numbers for solenoid valves, etc. to be mounted.
* VVX31-4A-F..... 1 set

Enter the product's part number in order, counting the 1st station from the left in the manifold arrangement, when viewing the individual port in front. The common port on the right side is plugged.

* Refer to Table (3) for available combinations between each electrical option (S, L, Z) and rated voltage.
* Surge voltage suppressor is integrated into the AC/Class B coil, as a standard.

Table (1) Model Orifice Diameter

Solenoid valve model	Orifice symbol (diameter)			
	1 (1.5 mmø)	2 (2.2 mmø)	3 (3 mmø)	4 (4 mmø)
VX31	●	●	●	—
VX32	—	●	●	●
VX33	—	●	●	●

Table (2) Solenoid Valve Option

Option symbol	Seal material		Body material/ Shading coil material	Guide pin material	Coil insulation type
	Main valve poppet	Fixed sealant			
A	FKM	FKM	C37	PPS	B
D	FKM	FKM	C37/Cu	Stainless steel	H

* Aluminum is only available as a material for the manifold base.
* The additives contained in oil are different depending on the type and manufacturers, so the durability of the seal materials will vary. For details, please consult with SMC.

Table (3) Rated Voltage Electrical Entry Electrical Option

Rated voltage	Class B	Class H								
		S	L	Z						
AC/DC	Voltage symbol	Voltage	With surge voltage suppressor	With light	With light and surge voltage suppressor					
						1	100 V	●	●	●
						2	200 V	●	●	●
						3	110 V	●	●	●
						4	220 V	— (Note)	— (Note)	●
						7	240 V	—	—	—
AC	Voltage symbol	Voltage	With surge voltage suppressor	With light	With light and surge voltage suppressor					
						8	48 V	●	—	—
						J	230 V	—	—	—
DC	Voltage symbol	Voltage	With surge voltage suppressor	With light	With light and surge voltage suppressor					
						5	24 V	●	—	—
6	12 V	●	—	—	—					

Note) Option S, Z are not available as surge voltage suppressor is integrated into the AC/Class B coil, as a standard.

Specifications

For Air

For Water

For Oil

For Steam

For Vacuum Pad

Construction

Dimensions

Series VX31/32/33

For Steam /Single Unit

Model / Valve Specifications

COM.

Passage symbol

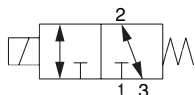

Port size	Orifice diameter (mmø)	Model	Max. operating pressure differential (MPa)	Flow characteristics		Max. system pressure (MPa)	Weight (g) ^(Note)	
			COM.	Av x 10 ⁻⁶ m ²	Cv converted			
1/8 (6A)	1.5	VX3114-01	0.7	1.9	0.08	1.0	380	
	2.2	VX3124-01	0.4	3.8	0.16			
	3	VX3134-01	0.2	5.8	0.24			
1/4 (8A)	1.5	VX3114-02	0.7	1.9	0.08		530	
		VX3124-02	0.4	3.8	0.16			
		VX3224-02	0.7	4.6	0.19			
	2.2	VX3324-02	1	4.6	0.19			730
		VX3134-02	0.2	5.8	0.24			
		VX3234-02	0.3	7.9	0.33			
	3	VX3334-02	0.6	7.9	0.33			730
		VX3244-02	0.2	12	0.50			
4	VX3344-02	0.3	12	0.50	730			
	3/8 (10A)	2.2	VX3224-03	0.7	4.6	0.19	530	
VX3324-03			1	4.6	0.19	730		
3		VX3234-03	0.3	7.9	0.33	530		
		VX3334-03	0.6	7.9	0.33	730		
		VX3244-03	0.2	12	0.50	530		
4		VX3344-03	0.3	12	0.50	730		

Note) Weight of grommet type. Add 10 g for conduit, 30 g for DIN terminal, and 60 g for conduit terminal type respectively.

Also, add 60 g for VX31□□, 80 g for VX32□□ and VX33□□ respectively for bracket option.

- Refer to "Glossary" on page 31 for details on the max. operating pressure differential and the max. system pressure.

Fluid and Ambient Temperature

Power source	Fluid temperature (°C)		Ambient temperature (°C)
	Solenoid valve option (symbol)		
	S, Q		
AC	183		-20 to 60

Valve Leakage

Internal Leakage

Seal material	Leakage rate (Air)
FFKM	150 cm ³ /min or less

External Leakage

Seal material	Leakage rate (Air)
PTFE	1 cm ³ /min or less

How to Order (Single Unit)

Model

Refer to Table (1) shown below for availability.

Orifice diameter

Refer to Table (1) shown below for availability.

Valve / Body type

4	COM. / Single unit
---	--------------------

Solenoid valve option

Refer to Table (2) shown below for availability.

Port size

Refer to Table (1) shown below for availability.

Thread type

Nil	Rc
T	NPTF
F	G
N	NPT

Electrical entry

G -Grommet
GS-With grommet surge voltage suppressor

C -Conduit

Suffix

Nil	—
Z	Oil-free spec.

Rated voltage

1	100 VAC 50/60 Hz	7	240 VAC 50/60 Hz
2	200 VAC 50/60 Hz	8	48 VAC 50/60 Hz
3	110 VAC 50/60 Hz	J	230 VAC 50/60 Hz
4	220 VAC 50/60 Hz		

* Refer to Table (3) shown below for availability.

Refer to page 23 for ordering coil only.

Electrical entry options:

- T** -With conduit terminal
- TS** -With conduit terminal and surge voltage suppressor
- TL** -With conduit terminal and light
- TZ** -With conduit terminal, surge voltage suppressor and light

* Refer to Table (3) for available combinations between each electrical option (S, L, Z) and rated voltage.

Specifications

For Air

For Water

For Oil

For Steam

For Vacuum Pad

Table (1) Model Orifice Diameter Port Size

Model	Solenoid valve model			Orifice symbol (diameter)			
	VX31	VX32	VX33	1 (1.5 mmø)	2 (2.2 mmø)	3 (3 mmø)	4 (4 mmø)
Port symbol (Port size)	01 (1/8)	—	—	●	●	●	—
	02 (1/4)	—	—	●	●	●	—
	—	02 (1/4)	02 (1/4)	—	●	●	●
	—	03 (3/8)	03 (3/8)	—	●	●	●

Table (2) Solenoid Valve Option

Option symbol	Seal material		Body material/ Shading coil material	Guide pin material	Coil insulation type
	Main valve poppet	Fixed sealant			
S	FFKM	PTFE	C37/Cu	Stainless steel	H
Q	FFKM	PTFE	Stainless steel/Ag	Stainless steel	H

Solenoid coil AC/Class H only

Table (3) Rated Voltage Electrical Option

AC/ DC	Rated voltage		Class H		
	Voltage symbol	Voltage	S With surge voltage suppressor	L With light	Z With light and surge voltage suppressor
AC	1	100 V	●	●	●
	2	200 V	●	●	●
	3	110 V	●	●	●
	4	220 V	●	●	●
	7	240 V	●	—	—
	8	48 V	●	—	—
DC	J	230 V	●	—	—
	5	24 V	DC specification is not available.		
	6	12 V	DC specification is not available.		

Construction

Dimensions

For Vacuum Pad / Single Unit Series VXV31/32/33

- Vacuum circuit side is suited for a large orifice. Supply pressure side is suited for high pressure and a vacuum pad.
- Construction and dimensions are the same as the VX3 series

Model / Valve Specifications

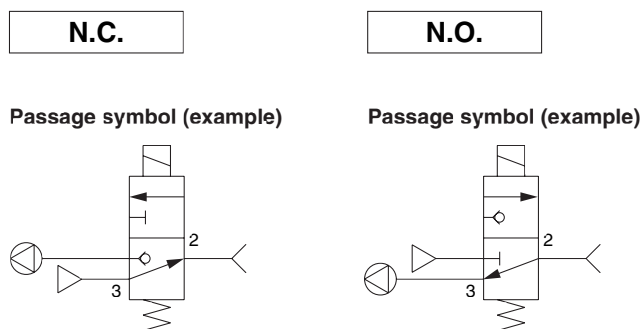

Port size	Orifice diameter (mmø)		Model	Operating pressure* (MPa)		Flow characteristics						Max. system pressure (MPa)	Note) Weight (g)			
	Port 1 side	Port 3 side		Port 1 side	Port 3 side	Passage: 1↔2			Passage: 2↔3							
						C[dm ³ /(s·bar)]	b	Cv	C[dm ³ /(s·bar)]	b	Cv					
1/8 (6A)	3	1.5	VXV3130-01	Low vacuum	0 to 0.5	0.82	0.20	0.20	0.29	0.32	0.08	2.0	380			
	1.5	3	VXV3132-01	0 to 0.5	Low vacuum	0.29	0.32	0.08	0.82	0.20	0.20					
1/4 (8A)	3	1.5	VXV3130-02	Low vacuum	0 to 0.5	0.82	0.20	0.20	0.29	0.32	0.08			530		
	1.5	3	VXV3132-02	0 to 0.5	Low vacuum	0.29	0.32	0.08	0.82	0.20	0.20				730	
	4	2.2	VXV3240-02	Low vacuum	0 to 0.5	1.6	0.20	0.38	0.64	0.40	0.17					530
			VXV3340-02	0 to 0.9	0.64	0.40	0.17	1.6	0.20	0.38	730					
	2.2	4	VXV3242-02	0 to 0.5	Low vacuum	0.64	0.40	0.17	1.6	0.20						0.38
			VXV3342-02	0 to 0.9	Low vacuum	0.64	0.40	0.17	1.6	0.20	0.38					730
3/8 (10A)	4	2.2	VXV3240-03	Low vacuum	0 to 0.5	1.6	0.20	0.38	0.64	0.40	0.17			530		
			VXV3340-03	0 to 0.9	Low vacuum	0.64	0.40	0.17	1.6	0.20	0.38				730	
	2.2	4	VXV3242-03	0 to 0.5	Low vacuum	0.64	0.40	0.17	1.6	0.20	0.38					530
			VXV3342-03	0 to 0.9	Low vacuum	0.64	0.40	0.17	1.6	0.20	0.38					

Note) Weight of grommet type. Add 10 g for conduit, 30 g for DIN terminal, and 60 g for conduit terminal type respectively. Also, add 60 g for VX31□□, 80 g for VX32□□ and VX33□□ respectively for bracket option.

• Refer to "Glossary" on page 31 for details on the max. operating pressure differential and the max. system pressure.

* Low vacuum: 11p to 1.3 x 10²Pa

Fluid and Ambient Temperature

Power source	Fluid temperature (°C)	Ambient temperature (°C)
AC	-10 Note) to 60	-20 to 60
DC	-10 Note) to 60	-20 to 40

Note 1) Dew point temperature: -10°C or less

Valve Leakage

Internal Leakage / External Leakage

Seal material	Leakage rate Note)
	Air
NBR, FKM	1 cm ³ /min or less

Note) Value when air pressure is applied

Direct Operated 3 Port Solenoid Valve *Series* **VX31/32/33**

For Vacuum Pad / Single Unit

How to Order (Single Unit)

DC

AC/Class B coil (Built-in full-wave rectifier type)

VXV 31 3 0 [] [] - 01 [] 5 G 1 - []

VXV 31 3 0 [] [] - 01 [] 1 G R1 - []

Specifications

For Air

For Water

For Oil

For Steam

For Vacuum Pad

Model • Refer to Table (1) shown below for availability.

Orifice diameter • Refer to Table (1) shown below for availability.

Valve / Body type

0	N.C. / Single unit
2	N.O. / Single unit

Solenoid valve option • Refer to Table (2) shown below for availability.

Port size • Refer to Table (1) shown below for availability.

Suffix

Nil	—
Z	Oil-free spec.

Thread type

Nil	Rc
T	NPTF
F	G
N	NPT

Rated voltage

1	100 VAC 50/60 Hz	6	12 VDC
2	200 VAC 50/60 Hz	7	240 VAC 50/60 Hz
3	110 VAC 50/60 Hz	8	48 VAC 50/60 Hz
4	220 VAC 50/60 Hz	J	230 VAC 50/60 Hz
5	24 VDC		

* Refer to Table (3) shown below for availability.

Refer to page 23 for ordering coil only.

Bracket

Nil	None
B	With bracket

* Bracket is neither mountable nor removable

Built-in full-wave rectifier type

Electrical entry (AC/DC)

<p>G -Grommet</p> <p>GS-With grommet surge voltage suppressor</p>	<p>C -Conduit</p>
<p>T -With conduit terminal</p> <p>TS-With conduit terminal and surge voltage suppressor</p> <p>TL-With conduit terminal and light</p> <p>TZ-With conduit terminal, surge voltage suppressor and light</p>	<p>D -DIN terminal</p> <p>DS -DIN terminal with surge voltage suppressor</p> <p>DL -DIN terminal with light</p> <p>DZ -DIN terminal with surge voltage suppressor and light</p> <p>DO -For DIN terminal (without connector, gasket is included.)</p> <p>* DIN type is available with class B only.</p>

* Refer to Table (3) for available combinations between each electrical option (S, L, Z) and rated voltage.

* Surge voltage suppressor is integrated into the AC/Class B coil, as a standard

Table (1) Model Orifice Diameter Port Size

Model	Solenoid valve model			Orifice symbol (diameter) <small>Note)</small>	
	VXV31	VXV32	VXV33	3 (1.5/3 mmø)	4 (2.2/4 mmø)
Port symbol (Port size)	01 (1/8)	—	—	●	—
	02 (1/4)	—	—	●	—
	—	02 (1/4)	02 (1/4)	—	●
	—	03 (3/8)	03 (3/8)	—	●

Note) The orifice diameter shown above are for the supply pressure side/ vacuum side port.

Table (2) Solenoid Valve Option

Option symbol	Seal material		Body material	Guide pin material	Coil insulation type
	Main valve poppet	Fixed sealant			
Nil	NBR	NBR	C37	PPS	B
A	FKM	FKM			
G	NBR	NBR	Stainless steel	PPS	B
H	FKM	FKM			

Table (3) Rated Voltage Electrical Option

Rated voltage	Class B			
	S	L	Z	
AC/DC	With surge voltage suppressor	With light	With light and surge voltage suppressor	
AC	1	100 V	●	
	2	200 V	●	
	3	110 V	●	
	4	220 V	— <small>Note)</small>	— <small>Note)</small>
	7	240 V	—	—
	8	48 V	—	—
DC	J	230 V	—	
	5	24 V	●	
	6	12 V	●	

Note) Option S, Z are not available as surge voltage suppressor is integrated into the AC/Class B coil, as a standard.

* Class H coil is not available.

For Vacuum Pad / Manifold Series **VVXV31/32/33**

- Construction and dimensions are the same as those of the VVX3 series.

Model / Valve Specifications

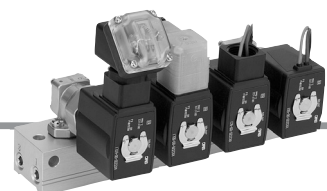

N.C.

N.O.

Passage symbol (example)

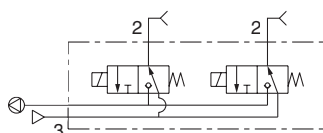

Passage symbol (example)

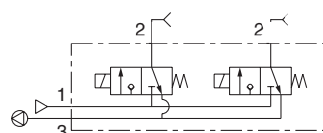

Orifice diameter (mmø)		Model	Operating pressure* (MPa)		Flow characteristics						Max. system pressure (MPa)
Port 1 side	Port 3 side		Port 1 side	Port 3 side	Passage: 1↔2			Passage: 2↔3			
					C[dm ³ /(s·bar)]	b	Cv	C[dm ³ /(s·bar)]	b	Cv	
3	1.5	VXV3131-00	Low vacuum	0 to 0.5	0.82	0.20	0.20	0.29	0.32	0.08	2.0
1.5	3	VXV3133-00	0 to 0.5	Low vacuum	0.29	0.32	0.08	0.82	0.20	0.20	
4	2.2	VXV3241-00	Low vacuum	0 to 0.5	1.6	0.20	0.38	0.64	0.40	0.17	
		VXV3341-00		0 to 0.9							
2.2	4	VXV3243-00	0 to 0.5	Low vacuum	0.64	0.40	0.17	1.6	0.20	0.38	
		VXV3343-00	0 to 0.9								

• Refer to "Glossary" on page 31 for details on the max. operating pressure differential and the max. system pressure
* Low vacuum: Up to 3×10^2 Pa

Fluid and Ambient Temperature

Power source	Fluid temperature (°C)	Ambient temperature (°C)
AC	-10 (Note) to 60	-20 to 60
DC	-10 (Note) to 60	-20 to 40

Note 1) Dew point temperature: -10°C or less

Valve Leakage

Internal Leakage / External Leakage

Seal material	Leakage rate (Note)
	Air
NBR, FKM	1 cm ³ /min or less

Note) Value when air pressure is applied

How to Order (Solenoid Valve for Manifold)

DC

AC/Class B coil (Built-in full-wave rectifier type)

Model
Refer to Table (1) shown below for availability.

Valve / Body type

1	N.C. / Manifold
3	N.O. / Manifold

VXV **31** **3** **1** - 00 - **5** **G** **1**

VXV **31** **3** **1** - 00 - **1** **G** **R1**

Orifice diameter
Refer to Table (1) shown below for availability.

Suffix

Nil	—
Z	Oil-free spec.

Built-in full-wave rectifier type

Solenoid valve option
Refer to Table (2) shown below for availability.

Rated voltage

1	100 VAC 50/60 Hz	6	12 VDC
2	200 VAC 50/60 Hz	7	240 VAC 50/60 Hz
3	110 VAC 50/60 Hz	8	48 VAC 50/60 Hz
4	220 VAC 50/60 Hz	J	230 VAC 50/60 Hz
5	24 VDC		

Electrical entry (AC/DC)

G -Grommet
GS-With grommet surge voltage suppressor

C -Conduit

T -With conduit terminal
TS-With conduit terminal and surge voltage suppressor
TL-With conduit terminal and light
TZ-With conduit terminal, surge voltage suppressor and light

D -DIN terminal
DS-DIN terminal with surge voltage suppressor
DL -DIN terminal with light
DZ -DIN terminal with surge voltage suppressor and light
DO-For DIN terminal (without connector, gasket is included.)

* DIN type is available with class B only.

* Refer to Table (3) shown below for availability.

Refer to page 23 for ordering coil only.

How to Order Manifold Bases

VVX31
VVX32 **1** - **07** **1**
VVX33

Number of manifolds

02	2 stations
⋮	⋮
10	10 stations

Port size (Individual port)

1	Rc 1/8
2	Rc 1/4

* Common port sizes are all Rc 1/4.
* Indicating numbers shown below are for common ports.

Type	Vacuum side port	SUP side port
N.C.	1	3
N.O.	3	1

Suffix

Nil	—
Z	Oil-free spec.

Manifold base

Blanking plate part no.

For VXV31 VVX31-4A-

For VXV32/33: VVX32-4A-

Seal material

Nil	NBR
F	FKM

How to Order Manifold Assemblies (Example)

Enter the valve and blanking plate to be mounted under the manifold base part number.

Example
VVX311-05-1 1 set "*" is the symbol for mounting.
* VVX3131-00-1GR1.. 4 sets Add an "*" in front of the part numbers for solenoid valves, etc. to be mounted.
* VVX31-4A 1 set

D side U side

Enter the product's part number in order, counting the 1st station from the left in the manifold arrangement, when viewing the individual port in front. The common port on the right side is plugged.

T -With conduit terminal
TS-With conduit terminal and surge voltage suppressor
TL-With conduit terminal and light
TZ-With conduit terminal, surge voltage suppressor and light

D -DIN terminal
DS-DIN terminal with surge voltage suppressor
DL -DIN terminal with light
DZ -DIN terminal with surge voltage suppressor and light
DO-For DIN terminal (without connector, gasket is included.)

* DIN type is available with class B only.

* Refer to Table (3) for available combinations between each electrical option (S, L, Z) and rated voltage.
* Surge voltage suppressor is integrated into the AC/Class B coil, as a standard.

Table (1) Model Orifice Diameter

Solenoid valve model	Orifice symbol (diameter) ^{Note)}	
	3 (1.5/3 mmø)	4 (2.2/4 mmø)
VXV31	●	—
VXV32	—	●
VXV33	—	●

Note) The orifice diameter shows the supply pressure side/vacuum side.

Table (2) Solenoid Valve Option

Option symbol	Seal material		Body material	Guide pin material	Coil insulation type
	Main valve poppet	Fixed sealant			
Nil	NBR	NBR	C37	PPS	B
A	FKM	FKM			

* Aluminum is only available as a material for the manifold base.

Table (3) Rated Voltage Electrical Option

Rated voltage			Class B		
			S	L	Z
AC/DC	Voltage symbol	Voltage	With surge voltage suppressor	With light	With surge voltage suppressor
				●	
	●				
	●				
	●				
	●				
AC	Voltage symbol	Voltage	— Note)	With light	— Note)
				●	
				●	
				●	
				—	
				—	
DC	Voltage symbol	Voltage	●	With light	●
				●	
				—	
				—	
				—	
				—	

* Class H coil is not available.
Note) Option S, Z are not available as surge voltage suppressor is integrated into the AC/Class B coil, as a standard.

Specifications

For Air

For Water

For Oil

For Steam

For Vacuum Pad

Construction

Dimensions

Series VX31/32/33

For Air, Water, Oil, Steam

Construction

Single unit

Body material C37 Stainless steel

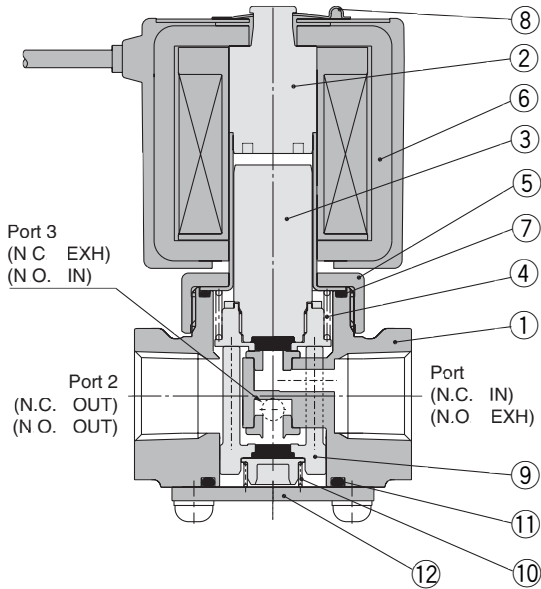

Component Parts

No.	Description	Material	
		Standard	Option
1	Body	C37	Stainless steel
2	Tube assembly ^{Note)}	Stainless steel, Cu	Stainless steel, Ag
3	Armature assembly	Stainless steel, C36, PTFE (NBR)	Stainless steel, PTFE (FKM, EPDM, FFKM)
4	Return spring	Stainless steel	
5	Nut	C37	C37/Ni plated
6	Solenoid coil	Class B molded	Class H molded
7	O-ring	(NBR)	(FKM, EPDM, PTFE)
8	Clip	SK	
9	Guide pin assembly	PPS, C36 (NBR)	Stainless steel (FKM, EPDM, FFKM)
10	Support spring	Stainless steel	
11	O-ring	(NBR)	(FKM, EPDM, PTFE)
12	Plate	Stainless steel	

The materials in parentheses are the seal materials.

Note) Cu and Ag are not applicable to the DC spec and to the AC spec with built-in full-wave rectifier.

Manifold

Base material: Aluminum

Manifold body material: C37

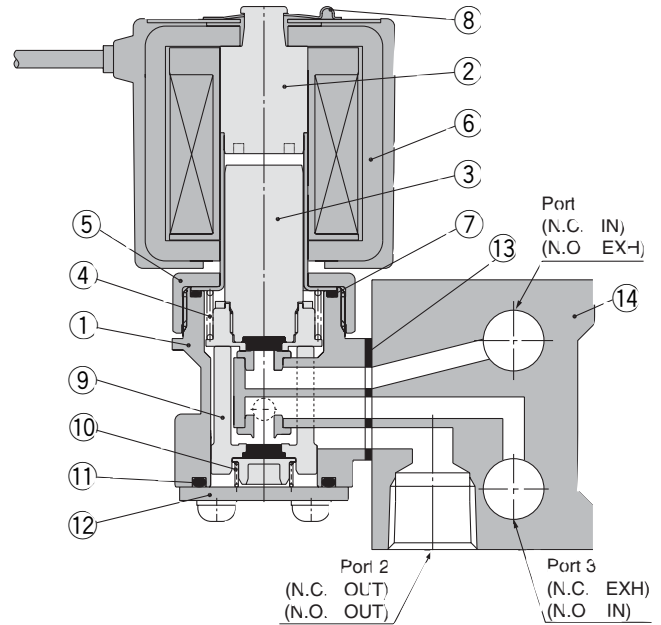

Component Parts

No.	Description	Material	
		Standard	Option
	Manifold body	C37	
2	Tube assembly ^{Note)}	Stainless steel, Cu	
3	Armature assembly	Stainless steel, C36, PTFE (NBR)	Stainless steel, PTFE (FKM, EPDM, FFKM)
4	Return spring	Stainless steel	
5	Nut	C37	C37/Ni plated
6	Solenoid coil	Class B molded	Class H molded
7	O-ring	(NBR)	(FKM, EPDM, PTFE)
8	Clip	SK	
9	Guide pin assembly	PPS, C36 (NBR)	Stainless steel (FKM, EPDM, FFKM)
10	Support spring	Stainless steel	
11	O-ring	(NBR)	(FKM, EPDM, PTFE)
12	Plate	Stainless steel	
13	Gasket	(NBR)	(FKM, EPDM, PTFE)
14	Base	Aluminum	

The materials in parentheses are the seal materials.

Note) Cu is not applicable to the DC spec and to the AC spec with built-in full-wave rectifier.

Dimensions Single Unit / Body Material C37, Stainless Steel

Normally closed (N.C.) VX31□0/VX32□0/VX33□0
 Normally open (N.O.) VX31□2/VX32□2/VX33□2
 Common (COM.) VX31□4/VX32□4/VX33□4

Grommet: G

Conduit: C

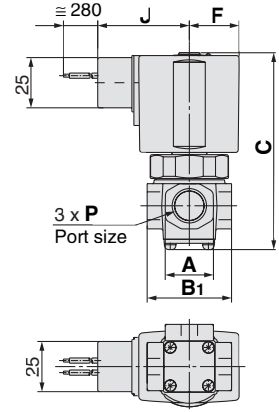
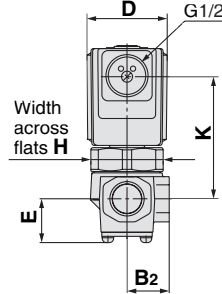
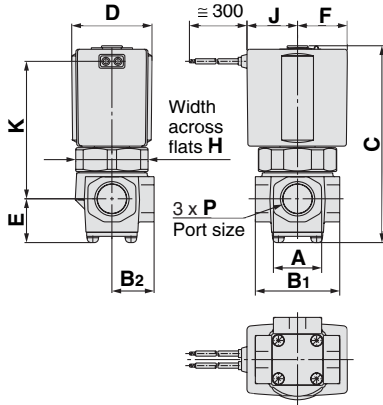

DIN terminal: D

Conduit terminal T

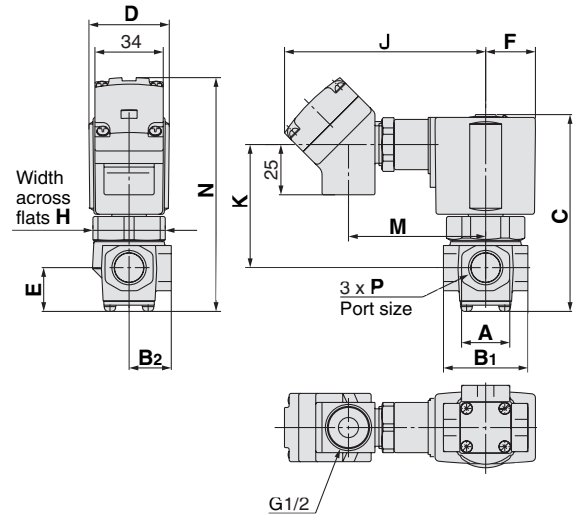
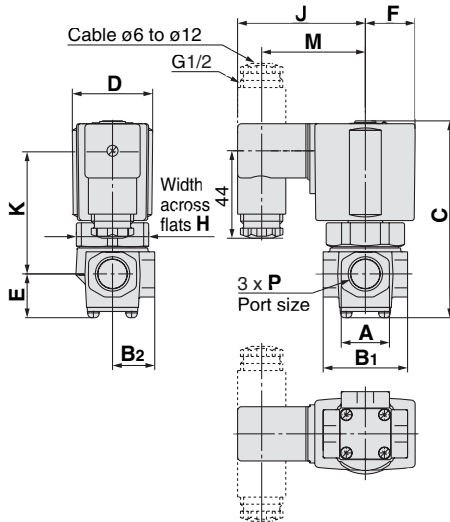

With bracket

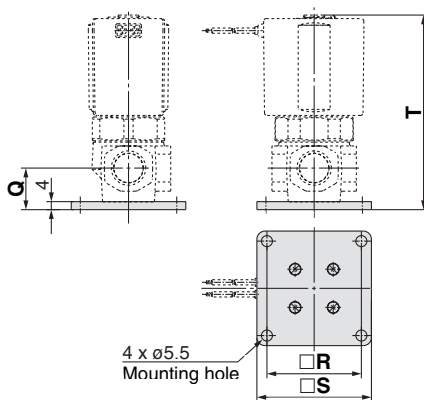

Specifications

For Air

For Water

For Oil

For Steam

For Vacuum Pad

Construction

Dimensions

(mm)

Model	Orifice diameter	Port size P	Electrical entry (AC/Class B)										
			Grommet		Conduit		DIN terminal		Conduit terminal				
N.C., N.O., COM.			J	K	J	K	J	K	M	J	K	M	N
VX31□□	ø1.5, ø2.2, ø3	1/8	30	46	48.5	41	65.5	42	53.5	100.5	41	69.5	91.5
VX31□□	ø1.5, ø2.2, ø3	1/4											
VX32□□	ø2.2, ø3, ø4	1/4, 3/8	33	56	51.5	51	68.5	52	56.5	103.5	51	72.5	105
VX33□□	ø2.2, ø3, ø4	1/4, 3/8	36	64.5	54	59.5	71	60.5	59	106	59.5	75	113

(mm)

Model	Orifice diameter	Port size P	B		C	D	E	F	H	Electrical entry (DC, AC/Class H)								Bracket mounting							
			B1	B2						Grommet		Conduit		DIN terminal		Conduit terminal		Q	R	S	T				
N.C., N.O., COM.										J	K	J	K	J	K	M	J	K	M	N					
VX31□□	ø1.5, ø2.2, ø3	1/8	22	36	18	76.5	30	19	19.5	27	19.5	50	40	42.5	58.5	42	46.5	92	42.5	61	93	17.5	40	50	75.5
VX31□□	ø1.5, ø2.2, ø3	1/4		41	20.5																				
VX32□□	ø2.2, ø3, ø4	1/4, 3/8	24	42	21	90	35	22	22.5	32	22.5	60	43	52.5	61.5	52	49.5	95	52.5	64	106.5	21	47	57	89
VX33□□	ø2.2, ø3, ø4	1/4, 3/8	24	42	21	98	40	22	25	36	25.5	68.5	46	61	64	60.5	52	98	61	66.5	114.5	21	47	57	97

Series VVX31/32/33

For Air, Oil / Manifold

Dimensions Manifold / Base Material Aluminum

Normally closed (N.C.)

Normally open (N.O.) VVX31/VVX32/VVX33

Common (COM.)

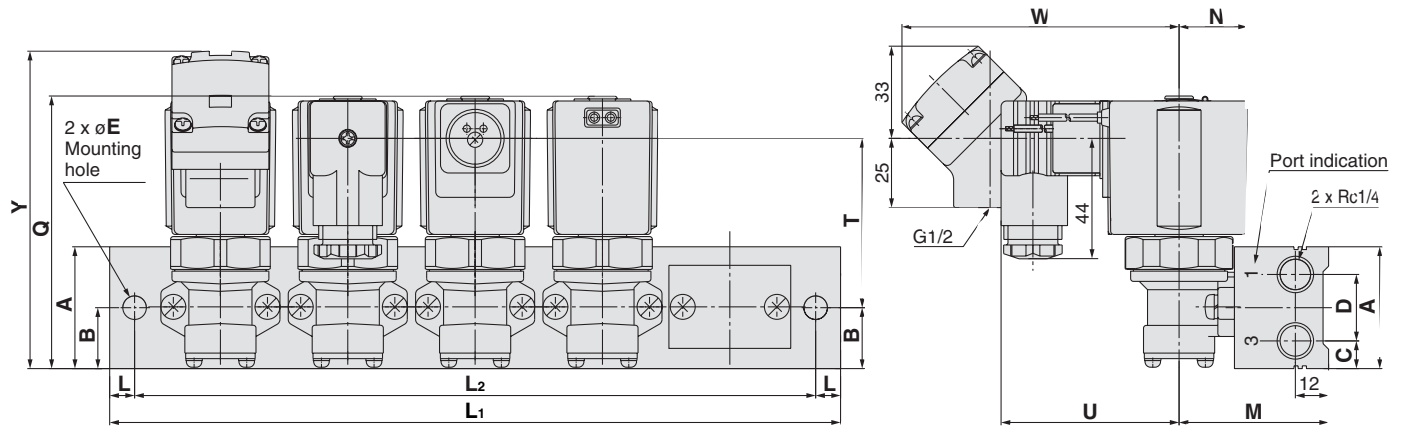

D side Stations 1 2 3 4 5 n U side

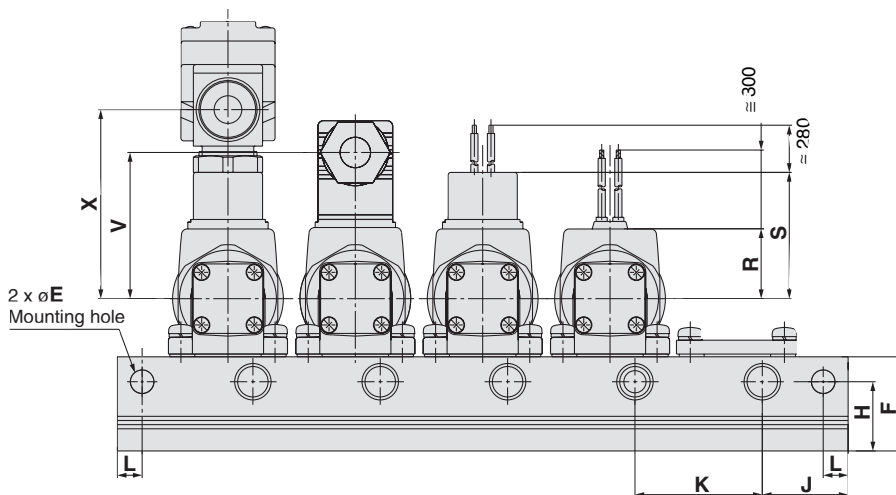

Model	Dimension	n (stations)								
		2	3	4	5	6	7	8	9	10
VVX31	L1	96	132	168	204	240	276	312	348	384
	L2	84	120	156	192	228	264	300	336	372
VVX32	L1	126	172	218	264	310	356	402	448	494
VVX33	L2	108	154	200	246	292	338	384	430	476

Model	A	B	C	D	E	F	H	J	K	L	M	N	Q	Electrical entry (DC, AC/Class H)												
														Grommet			Conduit				DIN terminal			Conduit terminal		
														R	S	T	T	U	V	W	X	Y				
VVX31	40	20	9	22	6.5	33	24	26	36	6	49	19.5	80.5	19.5	40	45.5	45	58.5	46.5	92	61	97				
VVX32	44	22	10	24	8.5	34	25	31	46	9	55	22.5	91	22.5	43	54	53.5	61.5	49.5	95	64	107.5				
VVX33	44	22	10	24	8.5	34	25	31	46	9	55	25	99.5	25.5	46	62	61.5	64	52	98	66.5	116				

Model	Electrical entry (AC/Class B)												
	Grommet			Conduit				DIN terminal			Conduit terminal		
	R	S	T	T	U	V	W	X	Y				
VVX31	30	48.5	44	45	65.5	53.5	100.5	69.5	95.5				
VVX32	33	51.5	52.5	53.5	68.5	56.5	103.5	72.5	106				
VVX33	36	54	60.5	61.5	71	59	106	75	114.5				

Replacement Parts

• Solenoid coil assembly part no.

DC

VX02 **1**N-**5**G

Series

1	VX31□□
2	VX32□□
3	VX33□□

Rated voltage (Note)

5	24 VDC
6	12 VDC

Note 1) Refer to Table (1) for available combinations.

Electrical entry

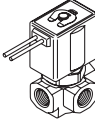
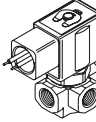
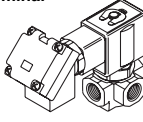
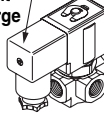
G -Grommet GS -With grommet surge voltage suppressor 	C -Conduit 
T -With conduit terminal TS -With conduit terminal and surge voltage suppressor TL -With conduit terminal and light TZ -With conduit terminal, surge voltage suppressor and light 	D -DIN terminal DS -DIN terminal with surge voltage suppressor DL -DIN terminal with light DZ -DIN terminal with surge voltage suppressor and light DO -For DIN terminal (without connector) 

* Refer to Table (1) for available combinations between each electrical option and rated voltage.

AC/Class B coil (Built-in full-wave rectifier type)

VX02 **1**N **1**G**R**

Series

1	VX31□□
2	VX32□□
3	VX33□□

Rated voltage (Note)

1	100 VAC 50/60 Hz
2	200 VAC 50/60 Hz
3	110 VAC 50/60 Hz
4	220 VAC 50/60 Hz
7	240 VAC 50/60 Hz
8	48 VAC 50/60 Hz
J	230 VAC 50/60 Hz

Note 1) Refer to Table (1) for available combinations.

Electrical entry

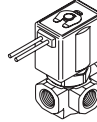
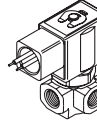
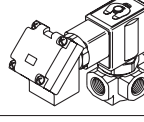
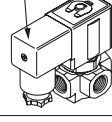
G -Grommet 	C -Conduit 
T -With conduit terminal TL -With conduit terminal and light 	D -DIN terminal DL -DIN terminal with light DO -For DIN terminal (without connector) 

* Refer to Table (1) for available combinations between each electrical option and rated voltage.
* Surge voltage suppressor is integrated into the AC/Class B coil, as a standard.

AC/Class H coil

VX02 **1**N-**1**G **H** **2** **Z**

Series

1	VX31□□
2	VX32□□
3	VX33□□

Rated voltage (Note)

1	100 VAC 50/60 Hz
2	200 VAC 50/60 Hz
3	110 VAC 50/60 Hz
4	220 VAC 50/60 Hz
7	240 VAC 50/60 Hz
8	48 VAC 50/60 Hz
J	230 VAC 50/60 Hz

Note 1) Refer to Table (1) for available combinations.

Electrical entry

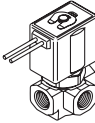
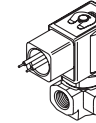
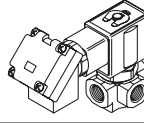
G -Grommet GS -With grommet surge voltage suppressor 	C -Conduit 
T -With conduit terminal TS -With conduit terminal and surge voltage suppressor TL -With conduit terminal and light TZ -With conduit terminal, surge voltage suppressor and light 	

* Refer to Table (1) for available combinations between each electrical option and rated voltage.

Table (1) Rated Voltage Electrical Option

Rated voltage		Class B			Class H			
		S	L	Z	S	L	Z	
AC/DC	Voltage symbol	Voltage						
	1	100 V	●	●	●	●	●	
	2	200 V	●	●	●	●	●	
	3	110 V	●	●	●	●	●	
	4	220 V	— (Note)	●	— (Note)	●	●	
	7	240 V	—	—	—	—	—	
8	48 V	—	—	—	—	—		
J	230 V	—	—	—	●	—	—	
DC	5	24 V	●	●	●	DC specification is not available.		
	6	12 V	●	—	—	DC specification is not available.		

Note) Option S, Z are not available since a surge voltage suppressor is integrated into the AC/Class B coil, as a standard

* When changing coils, AC/DC are not interchangeable with each other, and Class B and H coils are also not interchangeable with each other.

Specifications

For Air

For Water

For Oil

For Steam

For Vacuum Pad

Construction

Dimensions

Series VX31/32/33

For Air, Water, Oil, Steam

Replacement Parts

- Name plate part no.

AZ-T-VX Valve model

↑ Enter by referring to "How to Order"

- Clip part no.

For VX31 **VX021N-10**

For VX32: **VX022N-10**

For VX33: **VX023N-10**

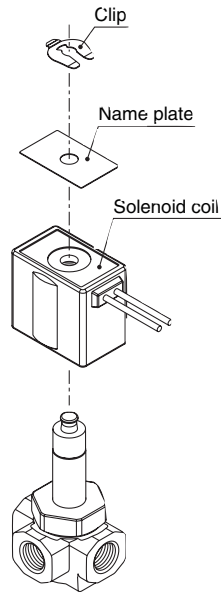

- DIN connector part no.

Without electrical option **GDM2A**

With electrical option **GDM2A**

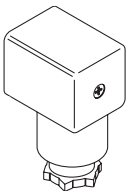

Electrical option

S	With surge voltage suppressor
L	With light
Z	With light and surge voltage suppressor

* Refer to Table (1) for available combinations between each electrical option (S, L, Z) and rated voltage.

Rated voltage

1	100 VAC, 110 VAC
2	200 VAC, 220 VAC, 230 VAC, 240 VAC
5	24 VDC
6	12 VDC
15	48 VAC

- Gasket part no. for DIN connector

VCW20-1-29-1

Solenoid Valve Flow Characteristics

(How to indicate flow characteristics)

1. Indication of flow characteristics

Indication of the flow characteristics in specifications for equipment such as solenoid valve, etc. is depending on "Table (1)".

Table (1) Indication of Flow Characteristics

Corresponding equipment	Indication by international standard	Other indications	Standards conforming to
Equipment for pneumatics	C, b	—	ISO 6358: 1989 JIS B 8390: 2000
	—	S	JIS B 8390: 2000 Equipment: JIS B 8373, 8374, 8375, 8379, 8381
		C_v	ANSI/(NFPA)T3.21.3: 1990
Equipment for controlling process fluids	A_v	—	IEC60534-2-3: 1997 JIS B 2005: 1995
	—	C_v	Equipment: JIS B 8471, 8472, 8473

2. Equipment for pneumatics

2.1 Indication according to the international standards

(1) Standards conforming to

ISO 6358: 1989 : Pneumatic fluid power—Components using compressible fluids—
Determination of flow-rate characteristics

JIS B 8390: 2000 : Pneumatic fluid power—Components using compressible fluids—
How to test flow-rate characteristics

(2) Definition of flow characteristics

Flow rate characteristics are indicated as a result of a comparison between sonic conductance C and critical pressure ratio b .

Sonic conductance C : Values which divide the passing mass flow rate of an equipment in a choked flow condition by the product of the upstream absolute pressure and the density in the standard condition.

Critical pressure ratio b : It is the pressure ratio which will turn to the choke flow (downstream pressure/upstream pressure) when it is smaller than this values. (critical pressure ratio)

Choked flow : It is the flow in which the upstream pressure is higher than the downstream pressure and where sonic speed in a certain part of an equipment is reached.
Gaseous mass flow rate is in proportion to the upstream pressure and not dependent on the downstream pressure. (choked flow)

Subsonic flow : Flow greater than the critical pressure ratio

Standard condition : Air in a temperature state of 20C, absolute pressure 0.1 MPa (= 100 kPa = 1 bar), relative humidity 65%.

It is stipulated by adding the abbreviation (ANR) after the unit depicting air volume. (standard reference atmosphere)

Standard conforming to: ISO 8778: 1990 Pneumatic fluid power—Standard reference atmosphere, JIS B 8393: 2000: Pneumatic fluid power—Standard reference atmosphere

(3) Formula of flow rate

It can be indicated by the practical unit as following.

When

$\frac{P_2 + 0.1}{P_1 + 0.1} \leq b$, **choked flow**

$$Q = 600 \times C (P_1 + 0.1) \sqrt{\frac{293}{273 + t}} \dots\dots\dots(1)$$

When

$\frac{P_2 + 0.1}{P_1 + 0.1} > b$, **subsonic flow**

$$Q = 600 \times C (P_1 + 0.1) \sqrt{1 - \frac{\left(\frac{P_2 + 0.1}{P_1 + 0.1} - b\right)^2}{1 - b}} \sqrt{\frac{293}{273 + t}} \dots\dots\dots(2)$$

Q : Air flow rate [dm³/min (ANR)], dm³ (Cubic decimeter) of SI unit are also allowed to described by ℓ (liter). 1 dm³ = 1 ℓ .

Solenoid Valve Flow Characteristics

C Sonic conductance [$\text{dm}^3/(\text{s}\cdot\text{bar})$]

b Critical pressure ratio [—]

P_1 Upstream pressure [MPa]

P_2 Downstream pressure [MPa]

t Temperature [C]

Note) Formula of subsonic flow is the elliptic analogous curve.

Flow characteristics curve is indicated in the Graph (1) For details, please use SMC's "Energy Saving Program"

Example)

Obtain the air flow rate for $P_1 = 0.4$ [MPa], $P_2 = 0.3$ [MPa], $t = 20$ [C] when a solenoid valve is performed in $C = 2$ [$\text{dm}^3/(\text{s}\cdot\text{bar})$] and $b = 0.3$.

According to formula 1, the maximum flow rate = $600 \times 2 \times (0.4 + 0.1) \times \sqrt{\frac{293}{273 + 20}} = 600$ [dm^3/min (ANR)]

Pressure ratio = $\frac{0.3 + 0.1}{0.4 + 0.1} = 0.8$

Based on the Graph (1), it is going to be 0.7 if it is read by the pressure ratio as 0.8 and the flow ratio to be $b = 0.3$
Hence, flow rate = Max. flow x flow ratio = $600 \times 0.7 = 420$ [dm^3/min (ANR)]

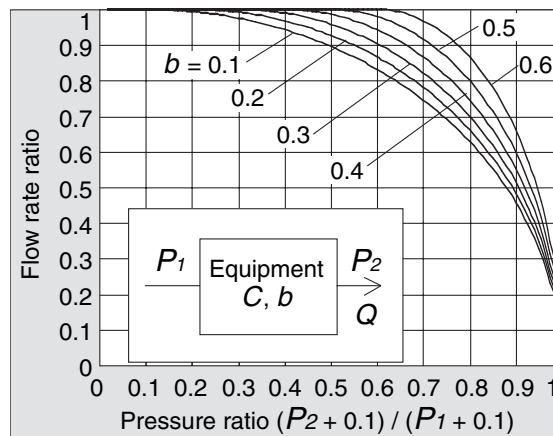

Graph (1) Flow characteristics line

(4) Test method

By attaching a test equipment with the test circuit indicated in Fig. (1) while maintaining to a certain amount which does not let the upstream pressure go down below 0.3 MPa, measure the maximum flow to be saturated in the first place. Next, measure this flow rate at 80%, 60%, 40%, 20% and the upstream and downstream pressure. And then, obtain the sonic conductance C from this maximum flow rate. Besides that, substitute each data of others for the formula of subsonic flow in order to find b , then obtain the critical pressure ratio b from that average.

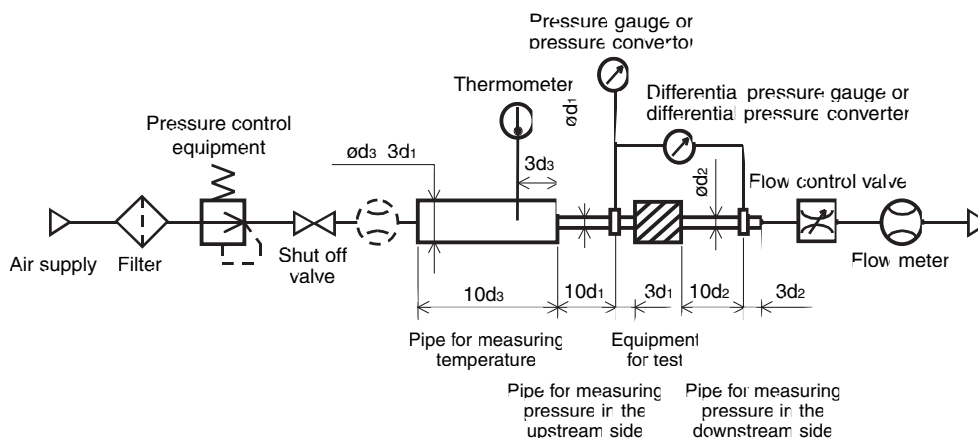

Fig. (1) Test circuit based on ISO 6358, JIS B 8390

Solenoid Valve Flow Characteristics

2.2 Effective area S

(1) Standards conforming to

**JIS B 8390: 2000: Pneumatic fluid power—Components using compressible fluids—
Determination of flow rate characteristics**

Equipment standards: JIS B 8373: 2 port solenoid valve for pneumatics

JIS B 8374: 3 port solenoid valve for pneumatics

JIS B 8375: 4 port, 5 port solenoid valve for pneumatics

JIS B 8379: Silencer for pneumatics

JIS B 8381: Fittings of flexible joint for pneumatics

(2) Definition of flow characteristics

Effective area S : is the cross-sectional area having an ideal throttle without friction deduced from the calculation of the pressure changes inside an air tank or without reduced flow when discharging the compressed air in a choked flow, from an equipment attached to the air tank. This is the same concept representing the “easy to run through” as sonic conductance C (effective area).

(3) Formula of flow rate

When

$\frac{P_2 + 0.1}{P_1 + 0.1} \leq 0.5$, **choked flow**

$$Q = 120 \times S (P_1 + 0.1) \sqrt{\frac{293}{273 + t}} \dots\dots\dots(3)$$

When

$\frac{P_2 + 0.1}{P_1 + 0.1} > 0.5$, **subsonic flow**

$$Q = 240 \times S \sqrt{(P_2 + 0.1)(P_1 - P_2)} \sqrt{\frac{293}{273 + t}} \dots\dots\dots(4)$$

Conversion with sonic conductance C :

$$S = 5.0 \times C \dots\dots\dots(5)$$

Q : Air flow rate[dm³/min(ANR)], dm³ (cubic decimeter) of SI unit is good to be described by ℓ (liter), too. 1 dm³ = 1 ℓ

S : Effective area [mm²]

P_1 : Upstream pressure [MPa]

P_2 : Downstream pressure [MPa]

t : Temperature [C]

Note) Formula for subsonic flow (4) is only applicable when the critical pressure ratio b is the unknown equipment. In the formula by sonic conductance C (2), it is the same formula when $b = 0.5$.

(4) Test method

By attaching the equipment for testing with the test circuit shown in Fig. (2), discharge air into the atmosphere until the pressure inside the air tank goes down to 0.25 MPa (0.2 MPa) from an air tank filled with compressed air of a certain pressure (0.5 MPa) which does not go down below 0.6 MPa. At this time, measure the discharging time and the residual pressure inside the air tank which had been left until it turned to be the normal values, and then determine the effective area S by using the following formula. The volume of air tank should be selected within the specified range by corresponding to the effective area of the equipment being tested. In the case of JIS B 8373, 8374, 8375, 8379, 8381, the pressure values are in parentheses and the coefficient of formula is 12.9.

$$S = 12.1 \frac{V}{t} \log_{10} \left(\frac{P_s + 0.1}{P + 0.1} \right) \sqrt{\frac{293}{T}} \dots\dots\dots(6)$$

S : Effective area [mm²]

V : Air tank capacity [dm³]

t : Discharging time [s]

P_s : Pressure inside air tank before discharging [MPa]

P : Residual pressure inside air tank after discharging [MPa]

T : Temperature inside air tank before discharging [K]

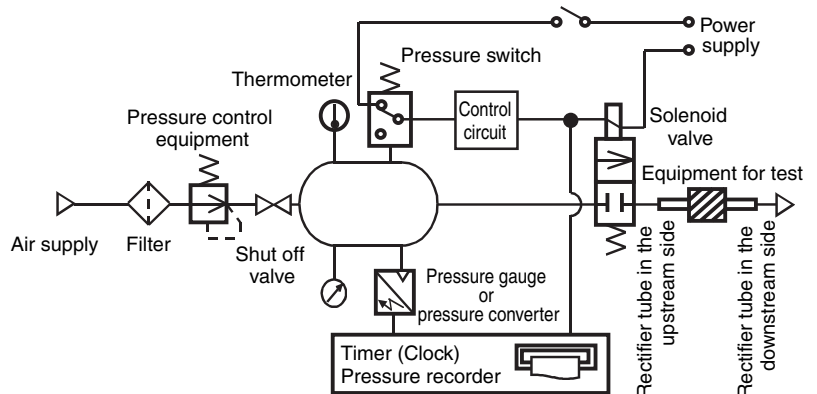

Fig. (2) Test circuit based on JIS B 8390

Solenoid Valve Flow Characteristics

2.3 Flow coefficient C_v factor

The United States Standard ANSI(NFPA)T3.21.3:1990: Pneumatic fluid power—Flow rating test procedure and reporting method for fixed orifice components

defines the C_v factor of flow coefficient by the following formula which is based on the test conducted by the test circuit analogous to ISO 6358.

$$C_v = \frac{Q}{114.5 \sqrt{\frac{P(P_2 + P_a)}{T_1}}} \dots\dots\dots(7)$$

- P Pressure drop between the static pressure tapping ports [bar]
 - P_1 Pressure of the upstream tapping port [bar gauge]
 - P_2 Pressure of the downstream tapping port [bar gauge]: $P_2 = P_1 - P$
 - Q Flow rate [dm^3/s standard condition]
 - P_a Atmospheric pressure [bar absolute]
 - T_1 Test conditions of the upstream absolute temperature [K]
- is $< P_1 + P_a = 6.5 \text{ bar absolute}$, $T_1 = 297.5 \text{ K}$, $0.07 \text{ bar } P \leq 14 \text{ bar}$

This is the same concept as effective area A which ISO6358 stipulates as being applicable only when the pressure drop is smaller than the upstream pressure and the compression of air does not become a problem

3. Equipment for process fluids

- (1) Standards conforming to **IEC60534-2-3: 1997: Industrial process control valves. Part 2: Flow capacity, Section Three-Test procedures**

JIS B 2005: 1995: Test method for the flow coefficient of a valve

- Equipment standards: JIS B 8471 Regulator for water**
- JIS B 8472: Solenoid valve for steam**
- JIS B 8473: Solenoid valve for fuel oil**

- (2) Definition of flow characteristics
 AV factor: Value of the clean water flow rate represented by m^3/s which runs through a valve (equipment for test) when the pressure difference is 1 Pa. It is calculated using the following formula.

$$AV = Q \sqrt{\frac{\rho}{P}} \dots\dots\dots(8)$$

- AV Flow coefficient [m^2]
- Q Flow rate [m^3/s]
- P Pressure difference [Pa]
- ρ Density of fluid [kg/m^3]

- (3) Formula of flow rate
 It is described by the known unit. Also, the flow characteristics line shown in the Graph (2).
 In the case of liquid:

$$Q = 1.9 \times 10^6 AV \sqrt{\frac{P}{G}} \dots\dots\dots(9)$$

- Q Flow rate [ℓ/min]
- AV Flow coefficient [m^2]
- P Pressure difference [MPa]
- G Relative density [water = 1]

In the case of saturated aqueous vapor:

$$Q = 8.3 \times 10^6 AV \sqrt{P(P_2 + 0.1)} \dots\dots\dots(10)$$

- Q Flow rate [m^3/s]
- AV Flow coefficient [m^2]
- P Pressure difference [Pa]
- P_1 Relative density [MPa]: $P = P_1 - P_2$
- P_2 Relative density [MPa]

Solenoid Valve Flow Characteristics

Conversion of flow coefficient:

$$Av = 28 \times 10^{-6} Kv = 24 \times 10^{-6} Cv \dots\dots\dots (1)$$

Here,

Kv factor: Value of the clean water flow rate represented by the m^3/h which runs through the valve at 5 to 40°C when the pressure difference is 1 bar

Cv factor (Reference values): It is the figures representing the flow rate of clean water by US gal/min which runs through the valve at 60°F, when the pressure difference is 1 lbf/in² (psi).

Values of pneumatic *Kv* are different from *Cv* because the testing method is different from each other.

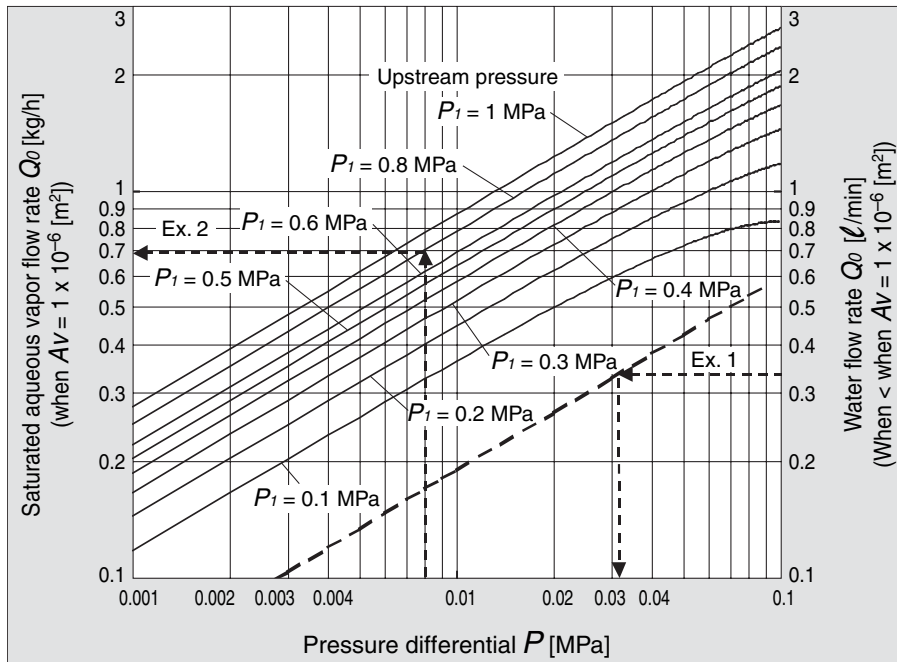

Graph (2) Flow characteristics line

Example 1

Obtain the pressure difference when water 15 [l/min] runs through the solenoid valve with an $Av = 45 \times 10^{-6} [m^2]$
 Since $Q0 = 15/45 = 0.33 [l/min]$, according to the Graph (2), if reading P when $Q0$ is 0.33, it will be 0.031 [MPa].

Example 2)

Obtain the flow rate of saturated aqueous vapor when $P1 = 0.8 [MPa]$, $P = 0.008 [MPa]$ with a solenoid valve with an $Av = 1.5 \times 10^{-6} [m^2]$.
 According to the Graph (2), if reading $Q0$ when $P1$ is 0.8 and P is 0.008, it is 0.7 [kg/h]. Hence, the flow rate $G = 0.7 \times 1.5 = 1.05 [kg/h]$.

(4) Test method

By attaching the equipment for testing with the test circuit shown in Fig. (3) and running water at 5 to 40°C measure the flow rate with a pressure difference of 0.075 MPa. However, the pressure difference needs to be set with a large enough difference so that the Reynolds number does not go below a range of 4×10^4
 By substituting the measurement results for formula (8) to figure out Av .

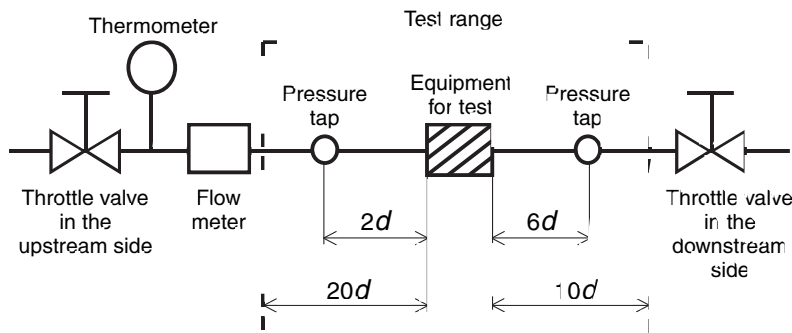
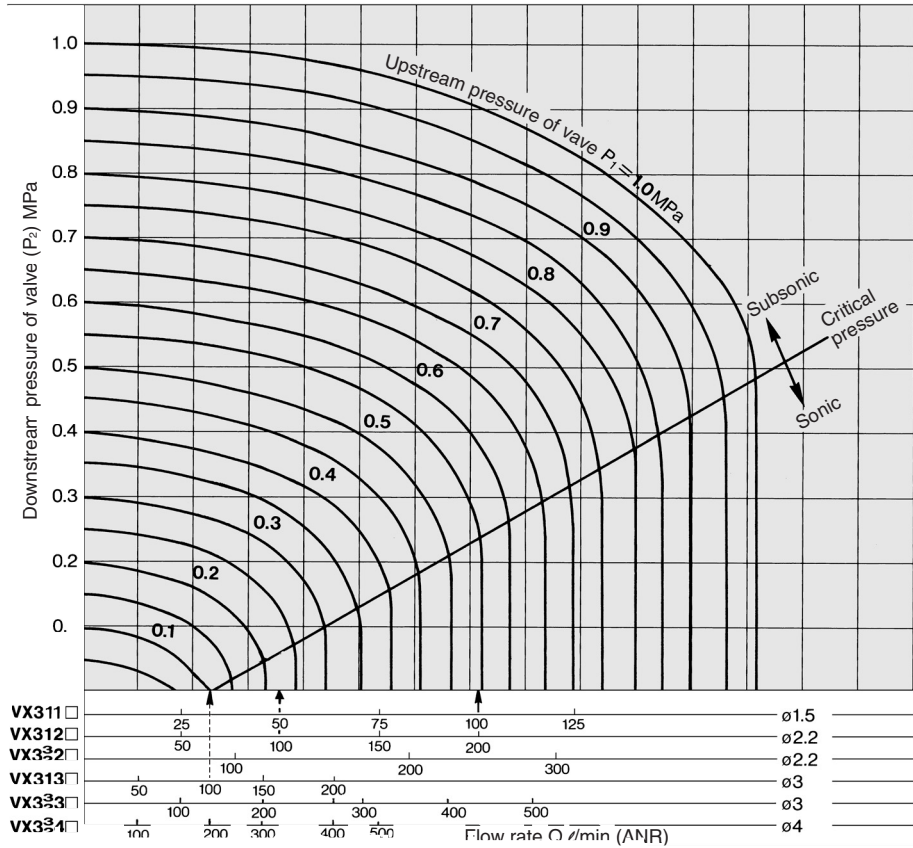

Fig. (3) Test circuit based on IEC60534-2-3, JIS B 2005

Flow Characteristics

Note) Use this graph as a guide. In the case of obtaining an accurate flow rate, refer to pages 25 through to 29.

For Air



How to read the graph

The sonic range pressure to generate a flow rate of 100 ℓ/min (ANR) is

$P_2 \approx 0.1 \text{ MPa}$ for a $\phi 3$ orifice (VX313 □)

$P_2 \approx 0.23 \text{ MPa}$ for a $\phi 2.2$ orifice (VX312 □), and

$P_2 \approx 0.55 \text{ MPa}$ for a $\phi 1.5$ orifice (VX311 □)

For Water

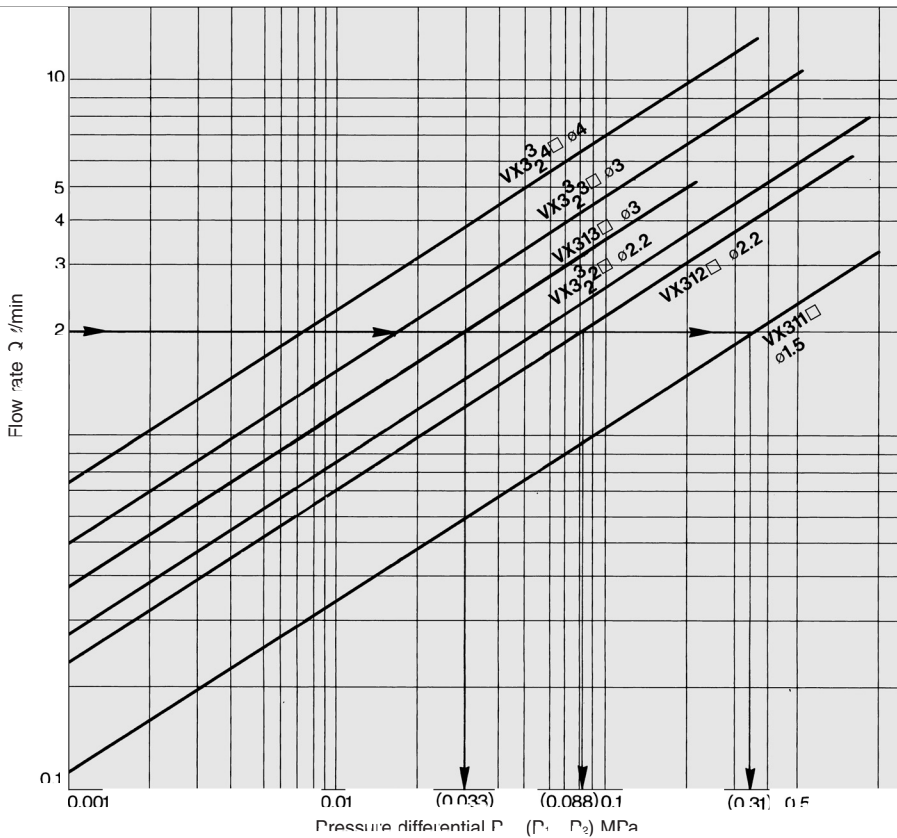

How to read the graph

When a water flow of 2 ℓ/min is generated,

$P_1 - P_2 \approx 0.033 \text{ MPa}$ for a $\phi 3$ orifice (VX313 □),

$P_1 - P_2 \approx 0.088 \text{ MPa}$ for a $\phi 2.2$ orifice (VX312 □), and

$P_1 - P_2 \approx 0.31 \text{ MPa}$ for a $\phi 1.5$ orifice (VX311 □)

Glossary

Pressure Terminology

1 Maximum operating pressure differential

The maximum pressure differential (the difference between the inlet and outlet pressure) which is allowed for operation, with the valve closed or open. When the downstream pressure is 0 MPa, this becomes the maximum operating pressure.

2 Minimum operating pressure differential

The minimum pressure differential (difference between the inlet pressure and the outlet pressure) required to keep the main valve fully opened.

3 Maximum system pressure

The maximum pressure that can be applied inside the pipelines (line pressure).

(The pressure differential of the solenoid valve unit must be less than the maximum operating pressure differential.)

4. Proof pressure

The pressure in which the valve must be withstood without a drop in performance after holding for one minute under prescribed pressure and returning to the operating pressure range. (value under the prescribed conditions)

Electrical Terminology

1 Apparent power (VA)

Volt-ampere is the product of voltage (V) and current (A). Power dissipation (W): For AC, $W = V \cdot A \cdot \cos\theta$. For DC, $W = V \cdot A$.

(Note) $\cos\theta$ shows power factor. $\cos\theta = 0.6$

2 Surge voltage

A high voltage which is momentarily generated in the shut-off unit by shutting off the power

3 Enclosure

A degree defined in the "JIS C 0920: Waterproof test of electric machinery/appliance and the degree of protection against the intrusion of solid foreign objects"

IP65: Dust tight, Low jetproof type

"Low jetproof type" means that no water intrudes inside an equipment that could hinder from operating normally by means of discharging water for 3 minutes in the prescribed manner. Take appropriate protection measures, since a device is not usable in an environment where a water drop is splashed.

Others

1 Material

NBR: Nitrile rubber

FKM: Fluoro rubber Trade name: Viton® DAI-E₂™, etc.

EPDM: Ethylene propylene rubber

PTFE: Polytetrafluoroethylene resin Trade name: Teflon®, Polyflon® etc

FFKM: Perfluoroelastomer

Trade name: Kalrez®, Chemraz®

2. Oil-free treatment

The degreasing and washing of wetted parts.

3. Passage symbol

In the JIS symbol () IN and OUT are in a blocked condition () but actually in the case of reverse pressure (OUT>IN), there is a limit to the blocking

() is used to indicate that blocking of reverse pressure is not possible.





Series VX31/32/33

Safety Instructions

The following safety instructions are intended to prevent a hazardous situation and/or equipment damage. These instructions indicate the level of potential hazard by all safety practices, including labels of "**Caution**", "**Warning**" or "**Danger**". To ensure safety, please observe ISO 4414 ^{Note 1)}, JIS B 8370 ^{Note 2)}.

 **Caution:** Operator error could result in injury or equipment damage.

 **Warning:** Operator error could result in serious injury or loss of life.

 **Danger :** In extreme conditions, there is a possible result of serious injury or loss of life.

Note 1) ISO 4414: Pneumatic fluid power – General rules relating to systems

Note 2) JIS B 8370: General Rules for Pneumatic Equipment

Warning

1. The compatibility of equipment is the responsibility of the person who designs the system or decides its specifications.

Since the products specified here are used in various operating conditions, their compatibility with a specific system must be based on specifications, post analysis and/or tests to meet a specific requirement. The expected performance and safety assurance will be the responsibility of the person who has determined the compatibility of the system. This person should continuously review the suitability of all items specified, referring to the latest catalog information and taking into consideration the possibility of equipment failure when configuring a system. Be particularly careful in determining the compatibility with the fluid to be used.

2. Only trained personnel should operate machinery and equipment.

The fluid can be dangerous if handled incorrectly. Assembly, handling or maintenance of the system should be performed by trained and experienced operators.

3. Do not service machinery/equipment or attempt to remove components until the safety is confirmed.

1. Inspection and maintenance of machinery/equipment should only be performed once measures to prevent falling or runaway of the driven object have been confirmed. Measures to prevent danger from a fluid should also be confirmed.

2. When equipment is to be removed, confirm the safety processes mentioned above, release the fluid pressure and be certain there is no danger from fluid leakage or fluid remaining in the system.

3. Carefully restart the machinery, confirming that safety measures are being implemented.

4. If the equipment will be used in the following conditions or environment, please contact SMC first and be sure to take all necessary safety precautions.

1. Conditions and environments beyond the given specifications, or if product is used outdoors.

2. With fluids whose application causes concern due to the type of fluid or additives, etc.

3. An application which has the possibility of having a negative effect on people, property, and therefore requires special safety analysis.



3 Port Solenoid Valve for Fluid Control

Precautions 1

Be sure to read this before handling.

For detailed precautions on each series, refer to the main text.

Design

Warning

1. Cannot be used as an emergency shutoff valve, etc.

The valves presented in this catalog are not designed for safety applications such as an emergency shutoff valve. If the valves are used in this type of system, other reliable safety assurance measures should also be adopted.

2. Extended periods of continuous energization

The solenoid coil will generate heat when continuously energized. Avoid using in a tightly shut container. Install it in a well-ventilated area. Furthermore, do not touch it while it is being energized or right after it is energized.

3. This solenoid valve cannot be used for explosion proof applications.

4. Maintenance space

The installation should allow sufficient space for maintenance activities.

5. Liquid rings

In cases with a flowing liquid, provide a bypass valve in the system to prevent the liquid from entering the liquid seal circuit.

6. Actuator drive

When an actuator, such as a cylinder, is to be driven using a valve, take appropriate measures to prevent potential danger caused by actuator operation.

7. Pressure (including vacuum) holding

It is not usable for an application such as holding the pressure (including vacuum) inside of a pressure vessel because air leakage is entailed in a valve.

8. When the conduit type is used as equivalent to an IP65 enclosure, install a wiring conduit, etc.

9. When an impact, such as water hammer, etc., caused by the rapid pressure fluctuation is applied, the solenoid valve may be damaged. Give an attention to it.

Selection

Warning

1. Confirm the specifications.

Give careful consideration to the operating conditions such as the application, fluid and environment, and use within the operating ranges specified in this catalog.

2. Fluid

1) Type of fluid

Before using a fluid, confirm whether it is compatible with the materials from each model by referring to the fluids listed in this catalog. Use a fluid with a dynamic viscosity of 50 mm²/s or less. If there is something you do not know, please contact us.

2) Inflammable oil, Gas,

Confirm the specification for leakage in the interior and/or exterior area.

Selection

Warning

3) Corrosive gas

Cannot be used since it will lead to cracks by stress corrosion or result in other incidents.

4) Use an oil-free specification when any oily particle must not enter the passage.

5) Applicable fluid on the list may not be used depending on the operating condition.

Give adequate confirmation, and then determine a model, just because the compatibility list shows the general case.

3. Fluid quality

The use of a fluid which contains foreign matter can cause problems such as malfunction and seal failure by promoting wear of the valve seat and armature, and by sticking to the sliding parts of the armature, etc. Install a suitable filter (strainer) immediately upstream from the valve. As a general rule, use 80 to 100 mesh.

When used to supply water to boilers, substances such as calcium and magnesium which generate hard scale and sludge are included. Since this scale and sludge can cause the valve to malfunction, install water softening equipment, and a filter (strainer) directly upstream from the valve to remove these substances.

4. Air quality

1) Use clean air.

Do not use compressed air which includes chemicals, synthetic oils containing organic solvents, salt or corrosive gases, etc., as it can cause damage or malfunction.

2) Install air filters.

Install air filters close to valves at their upstream side. A filtration degree of 5 μm or less should be selected.

3) Install an air dryer or after-cooler, etc.

Compressed air that includes excessive drainage may cause malfunction of valves and other pneumatic equipment. To prevent this, install an air dryer or after-cooler, etc.

4) If excessive carbon powder is generated, eliminate it by installing mist separators at the upstream side of valves.

If excessive carbon powder is generated by the compressor, it may adhere to the inside of the valves and cause a malfunction.

Refer to SMC's "Best Pneumatics 2004" Vol. 14 catalog for further details on compressed air quality.

5. Ambient environment

Use within the operable ambient temperature range. Confirm the compatibility between the product's composition materials and the ambient atmosphere. Be sure that the fluid used does not touch the external surface of the product.

6. Countermeasures against static electricity

Take measures to prevent static electricity since some fluids can cause static electricity.

7. For the low particle generation specification, confirm us separately.



3 Port Solenoid Valve for Fluid Control Precautions 2

Be sure to read this before handling.

For detailed precautions on each series, refer to the main text.

Selection

Caution

1. Leakage voltage

Particularly when using a resistor in parallel with a switching element and using a C-R element (surge voltage suppressor) to protect the switching element, take note that leakage current will flow through the resistor, C-R element, etc., creating a possible danger that the valve may not turn off.

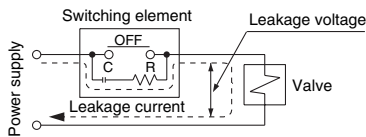

- AC/Class B coil: 5% or less of rated voltage
- AC/Class H coil: 20% or less of rated voltage
- DC coil: 2% or less of rated voltage

2. Low temperature operation

1. The valve can be used in an ambient temperature of between -10 to -20°C , however take measures to prevent freezing or solidification of impurities, etc.
2. When using valves for water application in cold climates, take appropriate countermeasures to prevent the water from freezing in tubing after cutting the water supply from the pump, by draining the water, etc.

When heating by steam, be careful not to expose the coil portion to steam. Installation of dryer, heat retaining of the body is recommended to prevent a freezing condition in which the dew point temperature is high and the ambient temperature is low, and the high flow runs.

Mounting

Warning

1. If air leakage increases or equipment does not operate properly, stop operation.

After mounting is completed, confirm that it has been done correctly by performing a suitable function test.

2. Do not apply external force to the coil section.

When tightening is performed, apply a wrench or other tool to the outside of the piping connection parts.

3. Be sure not to position the coil downwards.

When mounting a valve with its coil positioned downwards, foreign objects in the fluid will adhere to the iron core leading to a malfunction.

4. Do not warm the coil assembly with a heat insulator, etc.

Use tape, heaters, etc., for freeze prevention on the piping and body only. They can cause the coil to burn out.

5. Secure with brackets, except in the case of steel piping and copper fittings.

6. Avoid sources of vibration, or adjust the arm from the body to the minimum length so that resonance will not occur.

7. Painting and coating

Warnings or specifications printed or labeled on the product should not be erased, removed or covered up.

Piping

Caution

1. Preparation before piping

Before piping is connected, it should be thoroughly blown out with air (flushing) or washed to remove chips, cutting oil and other debris from inside the pipe.

Install piping so that it does not apply pulling, pressing, bending or other forces on the valve body.

2. Wrapping of pipe tape

When connecting pipes, fittings, etc., be sure that chips from the pipe threads and sealing material do not enter the valve.

Furthermore, when pipe tape is used, leave 1.5 to 2 thread ridges exposed at the end of the threads.

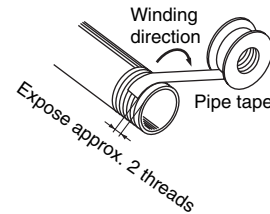

3. Avoid connecting ground lines to piping, as this may cause electric corrosion of the system.

4. Always tighten threads with the proper tightening torque.

When attaching fittings to valves, tighten with the proper tightening torque shown below.

Tightening Torque for Piping

Connection threads	Proper tightening torque N·m
Rc 1/8	7 to 9
Rc 1/4	12 to 14
Rc 3/8	22 to 24
Rc 1/2	28 to 30

5. Connection of piping to products

When connecting piping to a product, refer to its instruction manual to avoid mistakes regarding the supply port, etc.

6. Steam generated in a boiler contains a large amount of drainage.

Be sure to operate it with a drain trap installed.

7. In applications such as vacuum and non-leak specifications, use caution specifically against the contamination of foreign matter or airtightness of the fittings.



3 Port Solenoid Valve for Fluid Control

Precautions 3

Be sure to read this before handling.
For detailed precautions on each series, refer to the main text.

Wiring

⚠ Caution

- 1 As a rule, use electrical wire with a cross sectional area of 0.5 to 1.25 mm² for wiring. Furthermore, do not allow excessive force to be applied to the lines.
2. Use electrical circuits which do not generate chattering in their contacts.
3. Use voltage which is within 10% of the rated voltage.
In cases with a DC power supply where importance is placed on responsiveness, stay within 5% of the rated value. The voltage drop is the value in the lead wire section connecting the coil.
4. When a surge from the solenoid affects the electrical circuitry, install a surge absorber etc., in parallel with the solenoid.

Or adopt an option that comes with the surge voltage protection circuit. (However, a surge voltage occurs even if the surge voltage protection circuit is installed. For details, please consult with us.)

Electrical Connections

⚠ Caution

Grommet

Class H coil: AWG18 Insulator O.D. 2.2 mm
Class B coil: AWG20 Insulator O.D. 2.5 mm

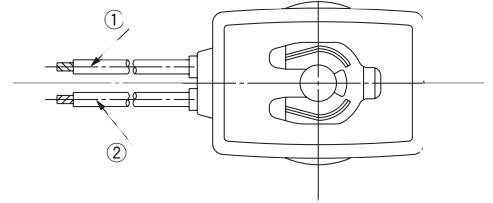

Rated voltage	Lead wire color	
	①	②
DC (Class B only)	Black	Red
100 VAC	Blue	Blue
200 VAC	Red	Red
Other AC	Gray	Gray

* There is no polarity

DIN terminal (Class B only)

Since internal connections are as shown below for the DIN terminal, make connections to the power supply accordingly.

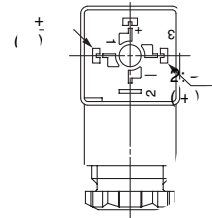

Terminal no.	1	2
DIN terminal	+ (-)	- (+)

* There is no polarity

- Use compatible heavy duty cords with cable C.D. of ø6 to 12.
- Use the tightening torques below for each section.

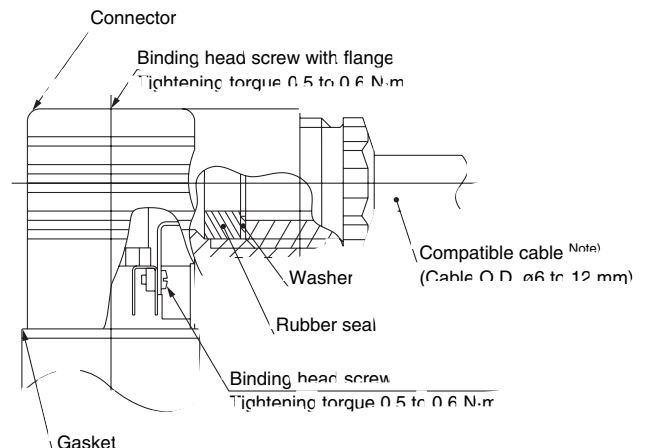

Note) For an outside cable diameter of ø9 to 12 mm, remove the internal parts of the rubber seal before using.



3 Port Solenoid Valve for Fluid Control Precautions 4

Be sure to read this before handling.
For detailed precautions on each series, refer to the main text.

Electrical Connections

Caution

Conduit terminal

In the case of the conduit terminal, make connections according to the marks shown below

- Use the tightening torques below for each section.
- Properly seal the terminal connection (G1/2) with the special wiring conduit, etc.

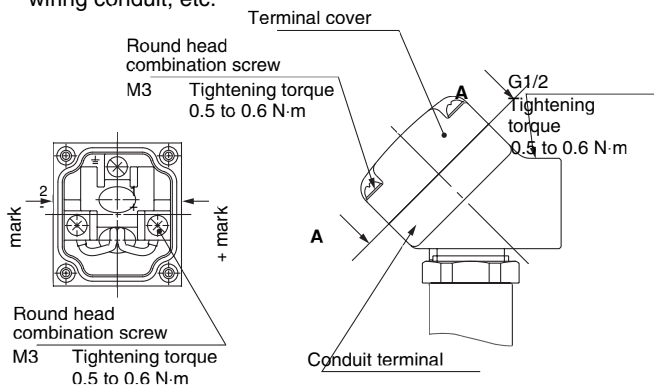

View A-A

(Internal connection diagram)

Conduit

When used as an IP65 equivalent, use seal (part no. VCW20-15 6) to install the wiring conduit. Also, use the tightening torque below for the conduit.

- Class H coil: AWG18 Insulator O.D. 2.2 mm
- Class B coil: AWG20 Insulator O.D. 2.4 mm

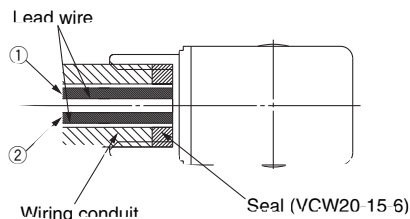

(Bore size G1/2 Tightening torque 0.5 to 0.6 N·m)

Rated voltage	Lead wire color	
	①	②
DC	Black	Red
100 VAC	Blue	Blue
200 VAC	Red	Red
Other AC	Gray	Gray

* There is no polarity for DC.

Description	Part no.
Seal	VCW20-15-6

Note) Please order separately.

Electrical Circuits

Caution

DC circuit

Grommet, Conduit terminal, DIN terminal

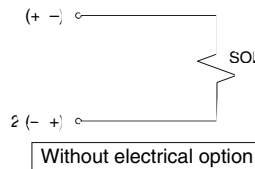

Without electrical option

Conduit terminal, DIN terminal

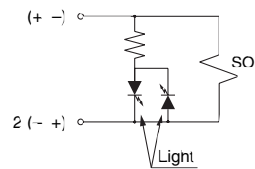

With light

Grommet, Conduit terminal, DIN terminal

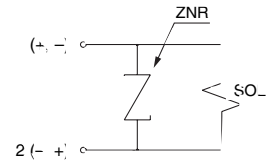

With surge voltage suppressor

Conduit terminal, DIN terminal

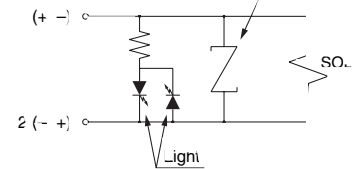

With light/surge voltage suppressor

AC/Class B coil circuit

* Surge voltage suppressor is attached to the AC/Class B coil, as a standard

Grommet, Conduit terminal, DIN terminal

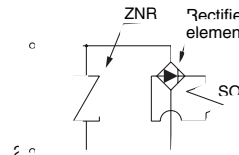

Without electrical option

Conduit terminal, DIN terminal

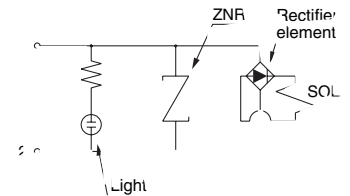

With light

AC/Class H coil circuit

Grommet, Conduit terminal

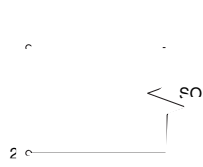

Without electrical option

Grommet, Conduit terminal

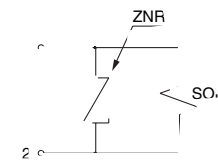

With surge voltage suppressor

Conduit terminal

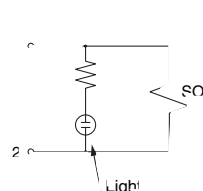

With light

Conduit terminal

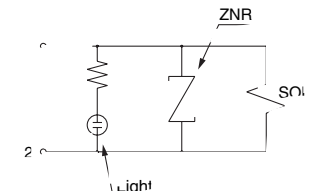

With light/surge voltage suppressor



3 Port Solenoid Valve for Fluid Control Precautions 5

Be sure to read this before handling.
For detailed precautions on each series, refer to the main text.

Operating Environment

Warning

1. Do not use the valves in an atmosphere having corrosive gases, chemicals, salt water, water, steam, or where there is direct contact with any of these.
2. Do not use in explosive atmospheres.
3. Do not use in locations subject to vibration or impact.
4. Do not use in locations where radiated heat will be received from nearby heat sources.
5. Employ suitable protective measures in locations where there is contact with water droplets, oil or welding spatter, etc.

Lubrication

Caution

1. This solenoid valve can be operated without lubrication.

If a lubricant is used in the system, use turbine oil Class 1, ISO VG32 (with no additive). But do not lubricate a valve with EPDM seal.

Refer to the table of brand name of lubricants compliant with Class 1 turbine oil (with no additive), ISO VG32.

Class 1 Turbine Oil (with no additive), ISO VG32

Classification of viscosity (cst) (40C)	Viscosity according to ISO Grade	32
Idemitsu Kosan Co.,Ltd.		Turbine oil P-32
Nippon Oil Corp.		Turbine oil 32
Cosmo Oil Co.,Ltd.		Cosmo turbine 32
Japan Energy Corp.		Kyodo turbine 32
Kygnus Oil Co.		Turbine oil 32
Kyushu Oil Co.		Stork turbine 32
Nippon Oil Corp.		Mitsubishi turbine 32
Showa Shell Sekiyu K.K.		Turbine 32
Tonen General Sekiyu K.K.		General R turbine 32
Fuji Kosan Co.,Ltd.		Fucoal turbine 32

Please contact SMC regarding Class 2 turbine oil (with additives), ISO VG32.

Maintenance

Warning

1 Removing the product

The valve will reach a high temperature when used with high temperature fluids. Confirm that the valve temperature has dropped sufficiently before performing work. If touched inadvertently, there is a danger of being burned.

1. Shut off the fluid supply and release the fluid pressure in the system.
2. Shut off the power supply.
3. Demount the product.

2. Low frequency operation

Switch valves at least once every 30 days to prevent malfunction. Also, in order to use it under the optimum state, conduct a regular inspection once a half year.

Maintenance

Caution

1. Filters and strainers

1. Be careful regarding clogging of filters and strainers.
2. Replace filter elements after one year of use, or earlier if the pressure drop reaches 0.1 MPa.
3. Clean strainers when the pressure drop reaches 0.1 MPa.

2. Lubrication

When using after lubricating, never forget to lubricate continuously.

3. Storage

In case of long term storage after use with heated water, thoroughly remove all moisture to prevent rust and deterioration of rubber materials, etc.

4. Exhaust the drain from an air filter periodically.

Operating Precautions

Warning

1. Valves will reach high temperatures from high temperature fluids. Use caution, as there is a danger of being burned if a valve is touched directly.



Record of changes

B edition	* Changes of fluid and ambient temperature For water, oil Max. temperature 40C → 60C	KZ
------------------	---	----

SMC Corporation

Akihabara UDX 15F,
4-14-1, Sotokanda, Chiyoda-ku, Tokyo 101-0021, JAPAN
Phone: 03-5207-8249 FAX: 03-5298-5362
URL <http://www.smcworld.com>
© 2007 SMC Corporation All Rights Reserved

Specifications are subject to change without prior notice
and any obligation on the part of the manufacturer

D-DN

1st printing JU printing LC 120DN Printec ir Japan

This catalog is printed on recycled paper with concern for the global environment.