

# Series CXWL

Ball Bushing Bearing Type:  
 $\varnothing 10$ ,  $\varnothing 16$ ,  $\varnothing 25$

## Construction

$\varnothing 10$

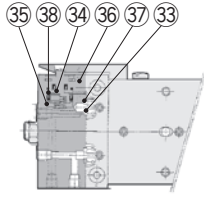

With end lock

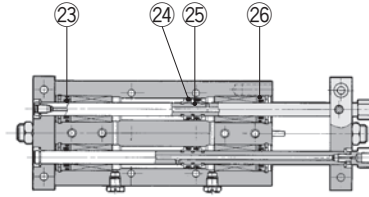

$\varnothing 16$

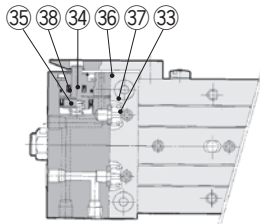

With end lock

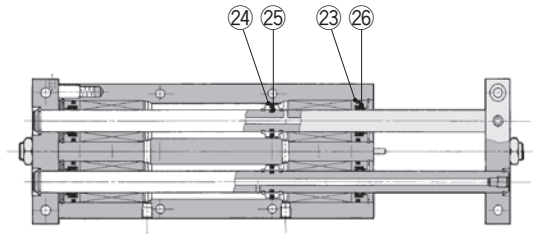

$\varnothing 25$

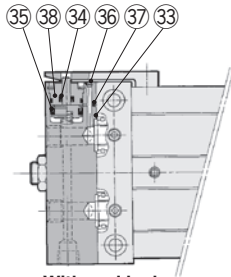

With end lock

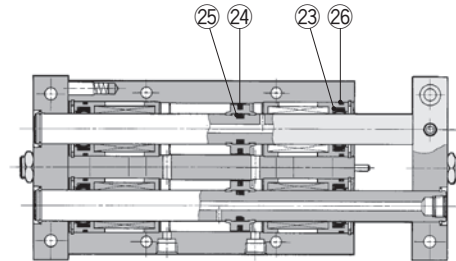

\* The numbers are the same as the "Construction" of the Best Pneumatics No.3 Series CXWL.

### Seal Kit List

No.	Description	Material	Note
23	Rod seal	NBR	25 is a non-replaceable part, so it is not included in the seal kit.
24	Piston seal		
25	Piston gasket		
26	Cylinder tube gasket		

### With End Lock

33	Body gasket	NBR	36 and 37 are non-replaceable parts, so they are not included in the seal kit.
34	Rod seal	NBR	
35	Piston seal	NBR	
36	Steel ball	High carbon chrome bearing steel	
37	Steel ball	High carbon chrome bearing steel	
38	O-ring	NBR	

### Replacement Parts: Seal Kit

Model	Kit no.	Contents
<b>Cylinder body</b>		
CXWL10	CXWL10-PS	Set of left nos. 23, 24, 26
CXWL16	CXWL16-PS	
CXWL25	CXWL25-PS	

\* Seal kit includes 23, 24 and 26. Order the seal kit with the part number for each model.

\* 25 is not replaceable.

\* Since the seal kit does not include a grease pack, order it separately.

Grease pack part no.: GR-S-010 (10 g)

### End lock

CXWL10	CXWL10R-PS	Set of left nos. 33, 34, 35, 38
CXWL16	CXWL16R-PS	
CXWL25	CXWL25R-PS	

\* Seal kit includes 33, 34, 35 and 38. Order the seal kit with the part number for each model.

\* Since the seal kit does not include a grease pack, order it separately.

Grease pack part no.: GR-S-010 (10 g)

Actuators

Modular F.R.L.  
Pressure Control Equipment

Air Preparation  
Equipment

Industrial Filters

Replacement  
Procedure

Actuators

Modular F.R.L.  
Pressure Control Equipment

Industrial Filters

# Series CXWL

Ball Bushing Bearing Type:  
 $\varnothing 20$ ,  $\varnothing 32$

## Construction

$\varnothing 20$

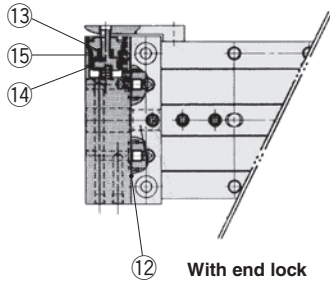

With end lock

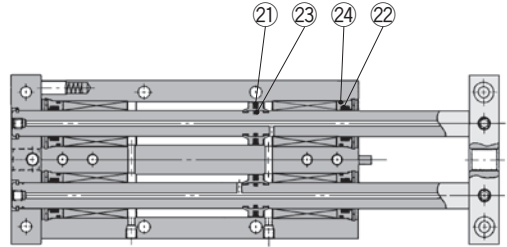

$\varnothing 32$

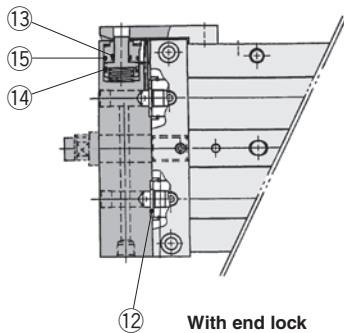

With end lock

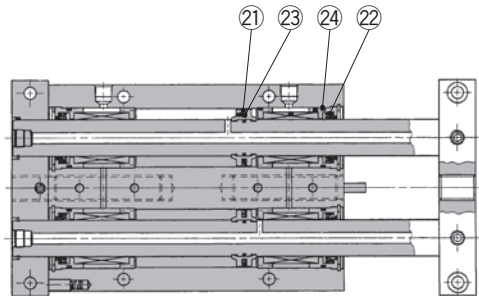

\* The numbers are the same as the "Construction" of the Best Pneumatics No.3 Series CXWL.

### Seal Kit List

No.	Description	Material	Note
②①	Piston seal	NBR	<b>23 is a non-replaceable part, so it is not included in the seal kit.</b>
②②	Rod seal		
23	Piston gasket		
②④	Cylinder tube gasket		

### With end lock

No.	Description	Material	Note
①②	Body gasket	NBR	
①③	Rod seal		
①④	Piston seal		
①⑤	O-ring		

### Replacement Parts: Seal Kit

Model	Kit no.	Contents
CXWL20	CXWL20-PS	Set of left nos. ②①, ②②, ②④
CXWL32	CXWL32-PS	

### Cylinder body

\* Seal kit includes ②①, ②② and ②④. Order the seal kit with the part number for each model.

\* ②③ is not replaceable.

\* Since the seal kit does not include a grease pack, order it separately.

**Grease pack part no.: GR-S-010 (10 g)**

### End lock

Model	Kit no.	Contents
CXWL20	CXWL20R-PS	Set of left nos. ①②, ①③, ①④, ①⑤
CXWL32	CXWL32R-PS	

\* Seal kit includes ①②, ①③, ①④ and ①⑤. Order the seal kit with the part number for each model.

\* Since the seal kit does not include a grease pack, order it separately.

**Grease pack part no.: GR-S-010 (10 g)**