

Circulating Fluid Temperature Controller

Refrigerated Thermo-chiller

Series *HRZ*

- Type of circulating fluid: Fluorinated fluids / Ethylene glycol aqueous solution / Clear water, Deionized water
- Temperature range setting: **-20 to 40°C / 20 to 90°C / -20 to 90°C**
- Cooling capacity: **1 kW / 2 kW / 4 kW / 8 kW / 10 kW to Max. 15 kW**
- Temperature stability: **±0.1°C**
- Refrigerant: **R404A (HFC) / R134a (HFC)**

Substantially more energy is saved by using a DC inverter refrigerator and inverter pump.

Inverter type
 Power consumption
1.1 kWh/h
 Facility water
2 l/min



● Overseas standards:

SEMATECH
S2-93, S8-95

SEMI standard
S2-0703, S8-0701, F47-0200



HRG

HRGC

HRZ

HRW

HEC

HEB

HED

Technical Data

Related Products

Energy Saving

Power consumption:

Max. 40% reduction (SMC comparison)

In addition to the optimum control of the expansion valve by the original controller, by recycling the heat emitted from the facility water, power consumption is dramatically reduced.

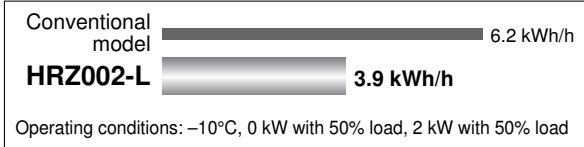

- Reduced running cost
- Contribution to the environmental preservation

Circulating fluid:

Max. 40% reduction (SMC comparison)

Enhanced temperature control technology and the dual tank construction achieved the reduced circulating fluid required for operation.

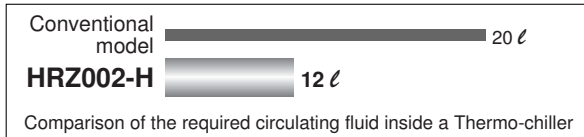

- Reduced initial cost
- Contribution to the environmental preservation

Double Inverter Type

Energy saving is substantially increased by using a DC inverter refrigerator and inverter pump.

Power consumption:

Max. 82% reduction (SMC comparison)

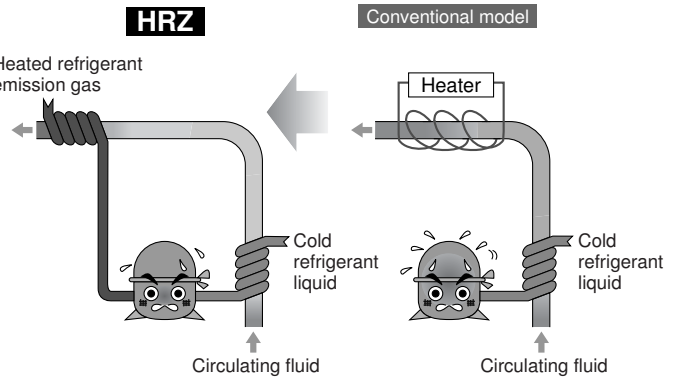
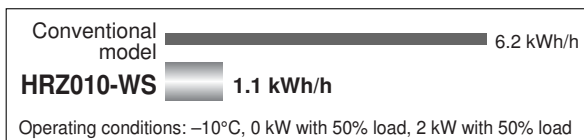

* This illustration is for an image only. For piping systems, refer to "Construction and Principles" on page 74.

Facility water:

Max. 75% reduction (SMC comparison)

Enhanced performance of a heat exchanger, recycle use of the emitted heat and the reduced power consumption achieved the reduced facility water amount.

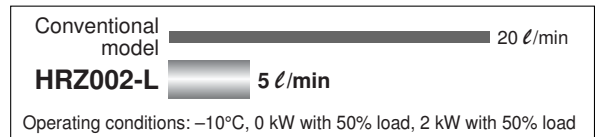

- Reduced facilities investment
- Space saved facility water equipment
- Reduced running cost

Facility water:

Max. 90% reduction (SMC comparison)

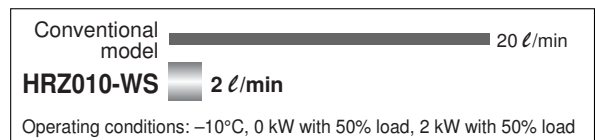

High Performance

Temperature stability: $\pm 0.1^\circ\text{C}$

(when a load is stable)

Enhanced temperature control technology achieved $\pm 0.1^\circ\text{C}$ temperature stabilities when a load is stable.

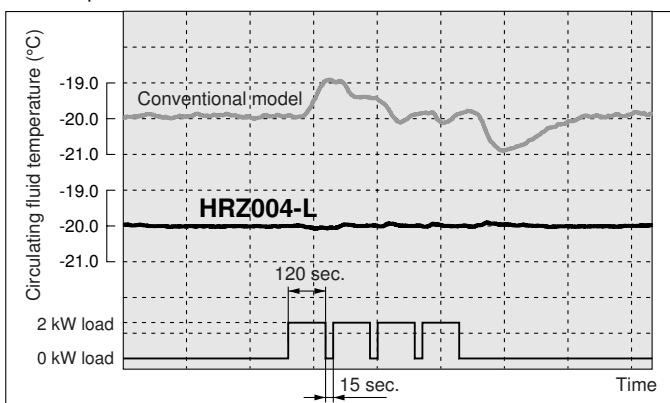

Cooling time: Max. 43% reduction

Special temperature control technology achieved the utmost performance, resulting in the reduced cooling time.

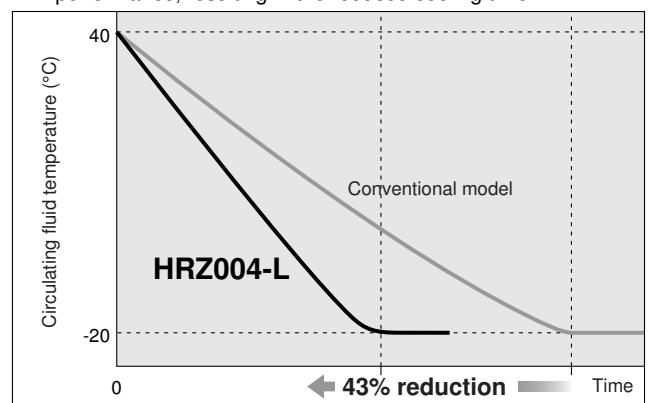

Space Saving

Installation area:

Max. 29% reduction (SMC comparison)

By emitting the heat from the rear side, ventilation slits on the side are unnecessary offering reduced installation space.

Conventional model: Body space: W400 mm x D845 mm
Ventilation space: 100 mm

HRZ008-H: Body space: W380 mm x D870 mm
Ventilation space: 0

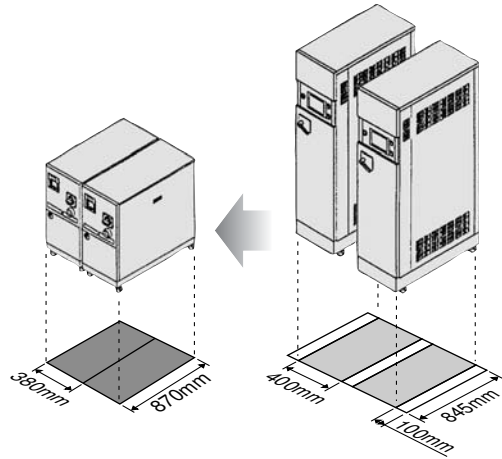

HRZ008-H 0.66 m²

Conventional model 0.93 m²

Leakless

All in tank

Housing the pump or heat exchanger inside the tank has eliminated any external leakage of the circulating fluid.

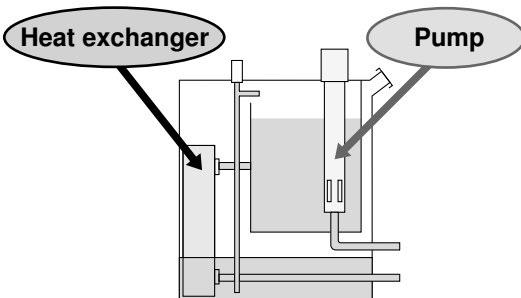

Communications

- Contact input/output signal
- Serial RS-485 communication
- Analog communication (Refer to "Options" on page 98.)
- DeviceNet™ communication (Refer to "Options" on page 98.)

DeviceNet™

Cooling capacity: Max. 15 kW

Up to 15 kW cooling capacity achieved.

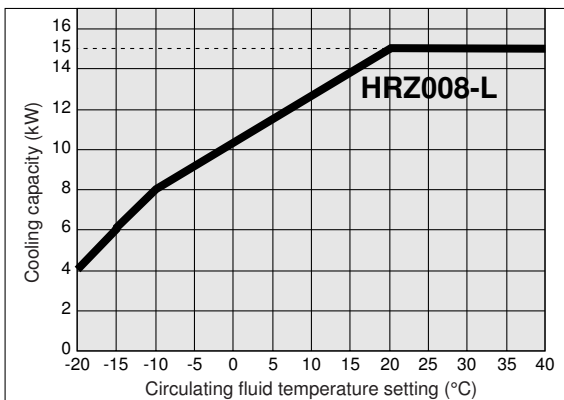

Wetted parts adopt the materials compatible for various circulating fluids.

(Stainless steel, EPDM, etc.)

- Fluorinated fluids: **Flourinert™ FC-3283, FC-40**
GALDEN® HT135, HT200
- Aqueous solution of 60% ethylene glycol
- Deionized water / Clear water

Regarding the fluid other than the above, please contact SMC. Flourinert™ is a trademark of 3M. GALDEN® is a registered trademark of Solvay Solexis, Inc.

Easy Maintenance

● Circulating fluid automatic recovery function (Refer to "Options" on page 99.)

Circulating fluid inside a Thermo-chiller tank can be recovered automatically. (Recovery volume: 15 ℓ to 17 ℓ)

- Reduced maintenance time
- Faster operation
- Reduced circulating liquid loss by evaporation or spill.

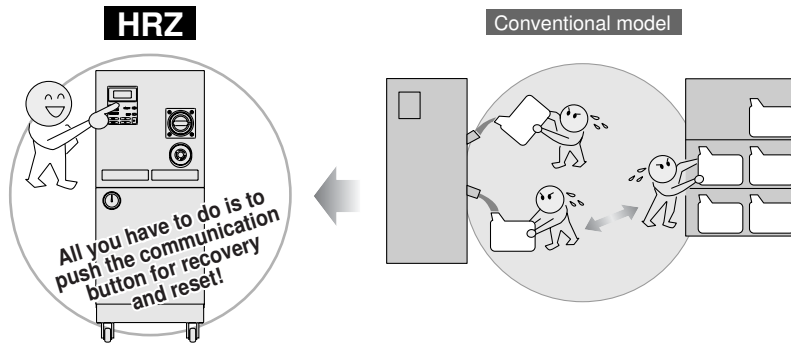

1 Normal operation

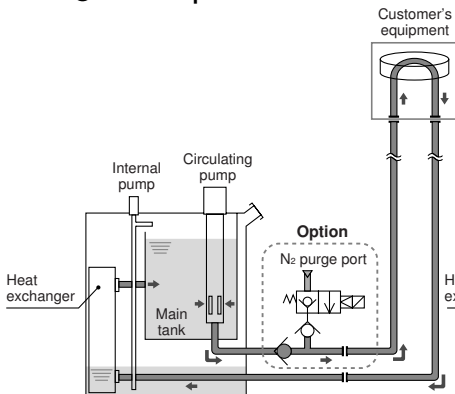

2 Recovery of circulating fluid

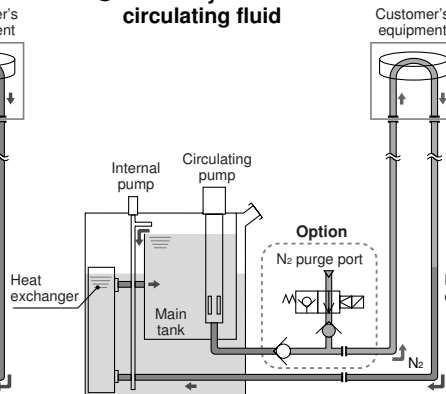

3 Fluid returns to the main tank from the circulating fluid recovery tank.

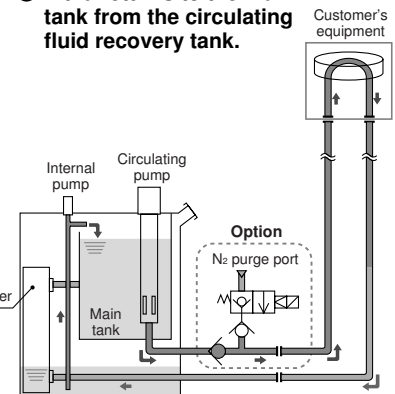

● Circulating fluid electrical resistance ratio control function (Refer to "Options" on page 98.)

(DI control kit)

● Easy maintenance

- Checking the electrical component parts accessible from the front side only
- Possible to replace the maintenance parts (such as a pump) without removing the pipings and discharging the circulating fluid.
- Various alarm displays (Refer to page 94.)

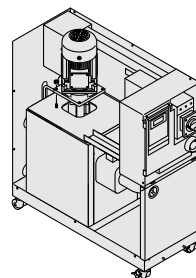
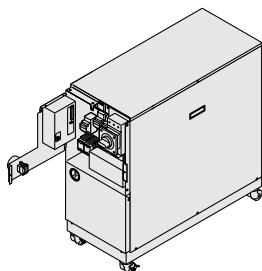

Application Examples

Semiconductor

Example: Temperature control of a chamber electrode

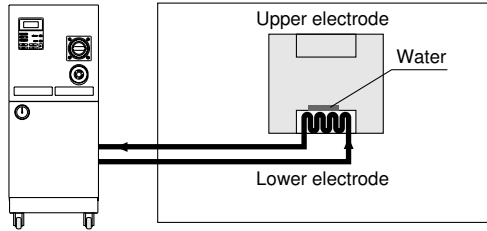

- Etching equipment
- Spatter equipment
- Cleaning equipment
- Coating equipment
- Dicing equipment
- Tester, etc.

Medical

Example: Blood preservation

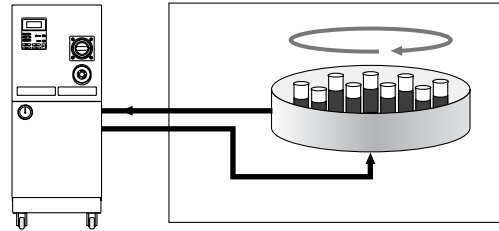

- X-ray instrument
- MRI
- Blood preservation equipment

Food

Example: Tofu (Bean curd) production

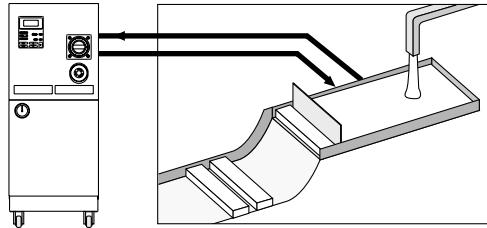

- Bottle-cleaning machine
- Tofu (Bean curd) production equipment
- Noodle-making machine, etc.

Water temperature control for forming tofu by mixing the boiled soybean milk and bittern

Analysis

Example: Electronic microscope

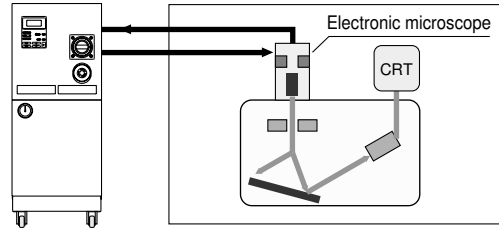

- Electron microscope
- X-ray analytical instrument
- Gas chromatography
- Sugar level analytical instrument, etc.

Prevents the distortion caused by the heat generated by the electronic gun in an electronic microscope.

Machine tool

Example: Laser machining

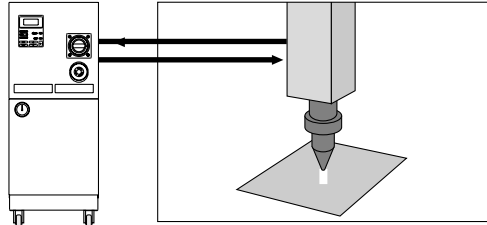

- Wire cutting
- Grinder
- Spot welding
- Plasma welding
- Laser machining, etc.

Temperature-controlling the laser generating tube enables the laser wavelength to be optimised, improving the accuracy of the machined cross sectional area.

Printing

Example: Printing temperature control

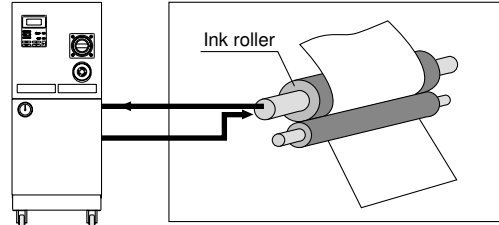

- Offset printing machine
- Automatic developing machine
- UV equipment, etc.

Temperature-controlling the ink roller enables to control the evaporation amount and viscosity of an ink and optimise the tint of colors.

Molding

Example: Injection molding

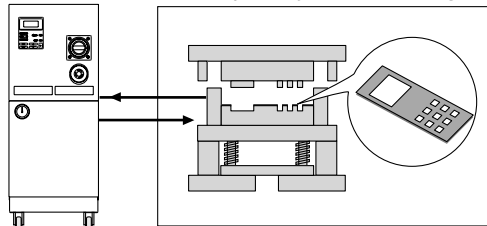

- Plastic molding
- Rubber molding
- Wire cable coating machine
- Injection molding, etc.

Temperature-controlling the mold results in improved product quality.

HRG

HRGC

HRZ

HRW

HEC

HEB

HED

Technical Data

Related Products

Construction and Principles

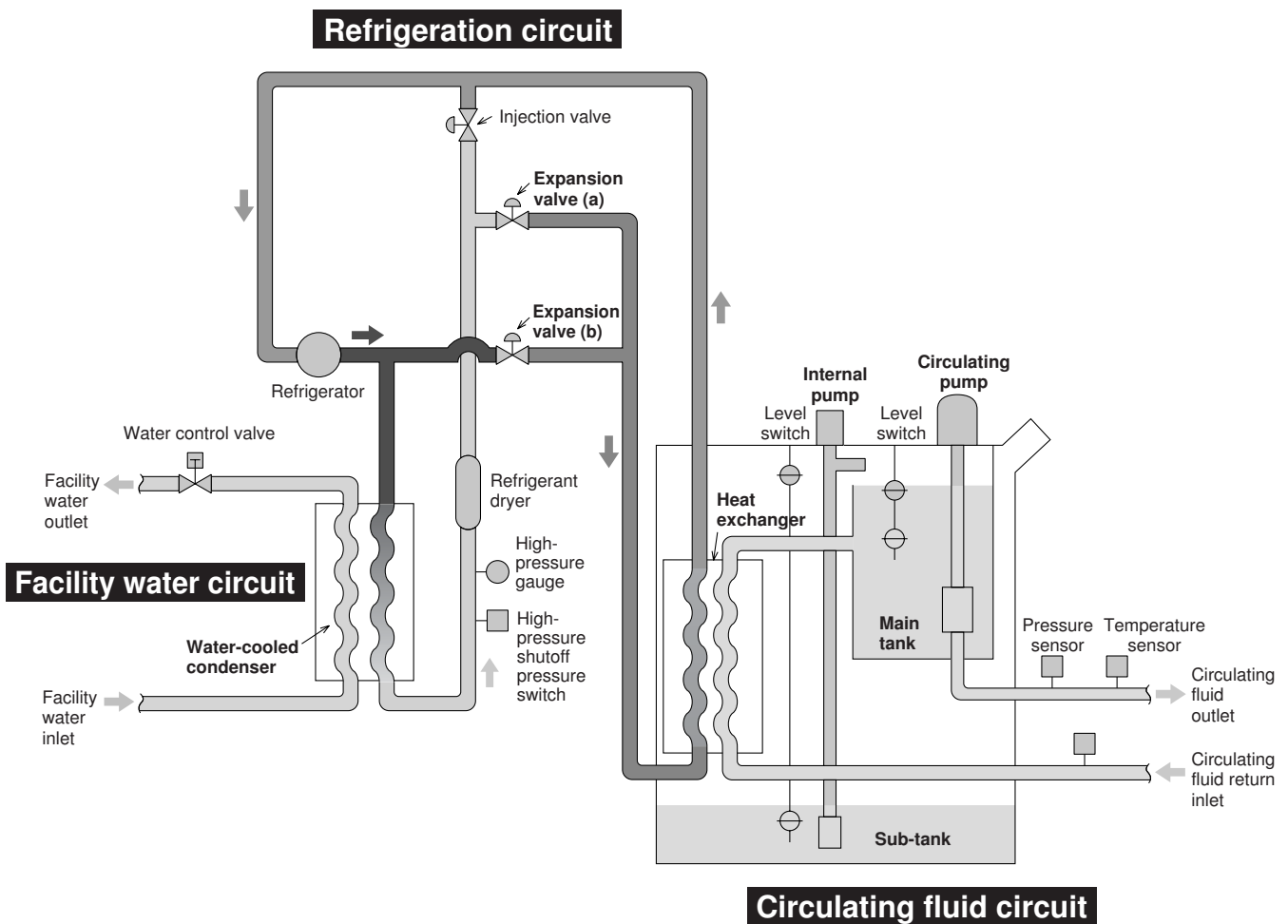

Circulating fluid circuit

With the **circulating pump**, circulating fluid will be discharged to the customer's equipment side. After the circulating fluid will heat or cool the customer's equipment side, it will be returned to the **main tank** via the **heat exchanger**.

A **sub-tank** is not used under the normal operation. It will be used when a circulating fluid is recovered from the customer's equipment side.

The **internal pump** is used to transfer a circulating fluid from the **sub-tank** to the **main tank**. (Refer to "Circulating fluid automatic recovery" function on page 72.)

Refrigeration circuit

When the circulating fluid temperature is rising higher than the set temperature, open the **expansion valve (a)** to introduce Freon gas at a lower temperature to the **heat exchanger**. With this, the circulating fluid will be cooled down.

Oppositely, when the circulating fluid is getting lower against the set temperature, open the **expansion valve (b)** and introduce Freon gas at a high temperature without going through the **water-cooled condenser** to the **heat exchanger**. With this heat, the circulating fluid will be heated.

CONTENTS

Series *HRZ*

Model Selection	
• Guide to Model Selection	P. 76
• Calculation of Required Cooling Capacity	P. 77, 78
• Precautions on Model Selection	P. 78
• Circulating Fluid Typical Physical Property Values	P. 79
● Fluorinated Fluid Type	
How to Order / Specifications	P. 80
Cooling/Heating Capacity	P. 81
Pump Capacity	P. 82
● Ethylene Glycol Type	
How to Order / Specifications	P. 83
Cooling/Heating Capacity	P. 84
Pump Capacity	P. 85
● Clear Water / Deionized Water Type	
How to Order / Specifications	P. 86
Cooling/Heating Capacity, Pump Capacity	P. 87
● Double Inverter Type	
How to Order / Specifications	P. 88
Cooling/Heating Capacity, Pump Capacity	P. 89
● Common Specifications	
Dimensions	P. 90, 91
Communications	P. 92
• Contact Input/Output Function	P. 92
• Serial RS-485	P. 93
• Connector Position	P. 93
Operation Panel Display	P. 94
Alarm	P. 94
● Optional Accessories	
• By-pass Piping Set	P. 95
• Anti-quake Bracket	P. 95
• 4 Port Manifold	P. 96
• DI Filter	P. 96
• Insulating Material for DI Filter	P. 96
• Aqueous Solution of 60% Ethylene Glycol	P. 97
• Densitometer	P. 97
● Options	
• Analog Communication	P. 98
• DeviceNet™ Communication	P. 98
• NPT Fittings	P. 98
• DI Control Kit	P. 98
• Circulating Fluid Automatic Recovery	P. 99
Specific Product Precautions	P. 100 to 102

HRG
HRGC
HRZ
HRW
HEC
HEB
HED
Technical Data
Related Products

Series HRZ Model Selection

Guide to Model Selection

1. How much is the temperature in degrees centigrade for the circulating fluid?

Temperature range which can be set with the Thermo-chiller

L : -20°C to 40°C (“L2” (clear water, deionized water specification) can be set 10°C to 40°C.)

H : 20°C to 90°C

W: -20°C to 90°C (Select “W” only when the temperature ranges of “L” or “H” are not applicable. HRZ010-W2S (clear water, deionized water specification) can be set 10°C to 60°C.)

Example) Customer requirement: 50°C (→ Temperature range 20°C to 90°C, “H” type will be appropriate.)

2. What kind of the circulating fluids will be used?

Relationship between circulating fluid (which can be used with the Thermo-chiller) and temperature

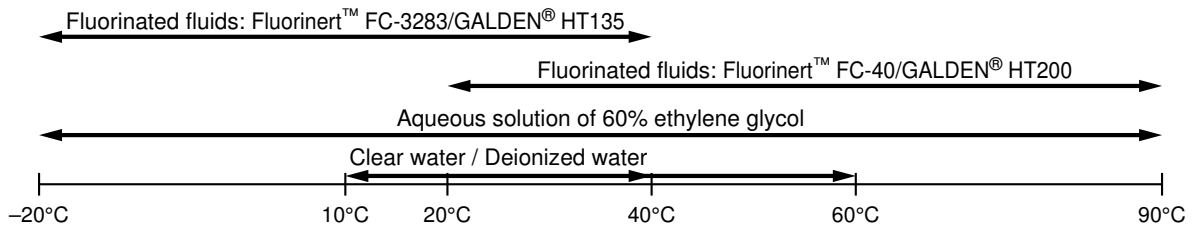

Example) Customer requirement: Fluorinated fluids

Based on the results 1. and 2., Cooling capacity relating “Fluorinated fluids” and “Temperature range 20°C to 90°C” is shown on page 81.

3. What is the kW for the required cooling capacity?

* Calculate the cooling capacity by referring to the following pages.

Example) Customer requirement: 5 kW →

Plot the point of intersection between the operating temperature (50°C) and the cooling capacity (5 kW) in the cooling capacity graph.

[Cooling Capacity Graph] Circulating Fluid: Fluorinated Fluids, Temperature Range: 20 to 90°C

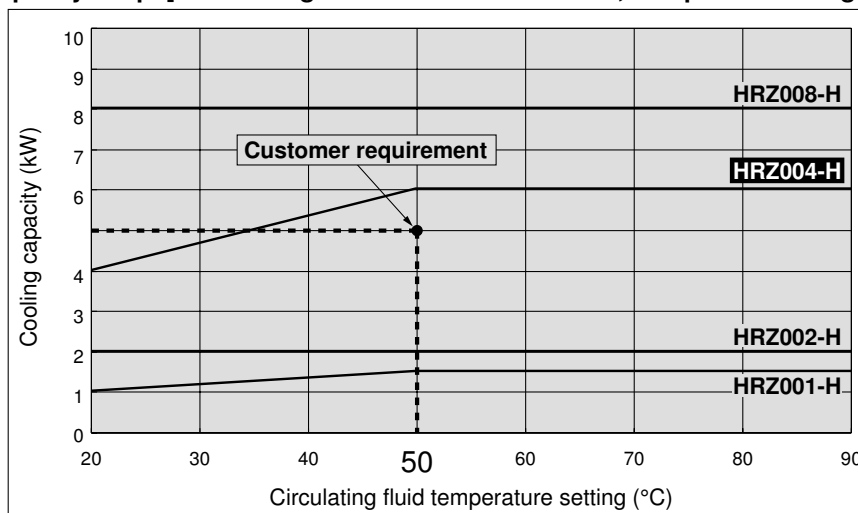

The point plotted in the graph is the requirement from your customer. Select the Thermo-chiller models exceeding this point. In this case, select the **HRZ004-H**.

Calculation of Required Cooling Capacity

Example 1: When the heat generation amount in the customer's equipment is known.

Heat generation amount Q: 3.5 kW

Cooling capacity = Considering a safety factor of 20%, $3.5 \times 1.2 = 4.2 \text{ kW}$

Example 3: When the heat generation amount in the customer's equipment is not known.

Obtaining the temperature difference between inlet and outlet by circulating the circulating fluid inside the customer's equipment.

Heat generation amount Q	: Unknown
Circulating fluid temperature difference ΔT (= $T_2 - T_1$)	: 6.0°C (6.0 K)
Circulating fluid outlet temperature T1	: 20°C (293.15 K)
Circulating fluid return temperature T2	: 26°C (299.15 K)
Circulating fluid flow rate L	: 20 ℓ /min
Circulating fluid	: Fluorinated fluid
	Density γ : $1.80 \times 10^3 \text{ kg/m}^3$
	Specific heat C: 0.96 $\times 10^3 \text{ J/(kg}\cdot\text{K)}$ (at 20°C)

* Refer to page 79 for the typical physical property values by circulating fluid.

$$Q = \frac{\Delta T \times L \times \gamma \times C}{60 \times 1000}$$

$$= \frac{6.0 \times 20 \times 1.80 \times 10^3 \times 0.96 \times 10^3}{60 \times 1000}$$

$$= 3456 \text{ W} = 3.5 \text{ kW}$$

Cooling capacity = Considering a safety factor of 20%,
 $3.5 \times 1.2 = 4.2 \text{ kW}$

Example of the conventional measurement units (Reference)

Unknown
6.0°C
20°C
26°C
1.2 m^3/h
Fluorinated fluid
Density γ : $1.80 \times 10^3 \text{ kg/m}^3$
Specific heat C: 0.23 kcal/kg \cdot °C (at 20°C)

* Refer to page 79 for the typical physical property values by circulating fluid.

$$Q = \frac{\Delta T \times L \times \gamma \times C}{860}$$

$$= \frac{6.0 \times 1.2 \times 1.80 \times 10^3 \times 0.23}{860}$$

$$= 3.5 \text{ kW}$$

Cooling capacity = Considering a safety factor of 20%,
 $3.5 \times 1.2 = 4.2 \text{ kW}$

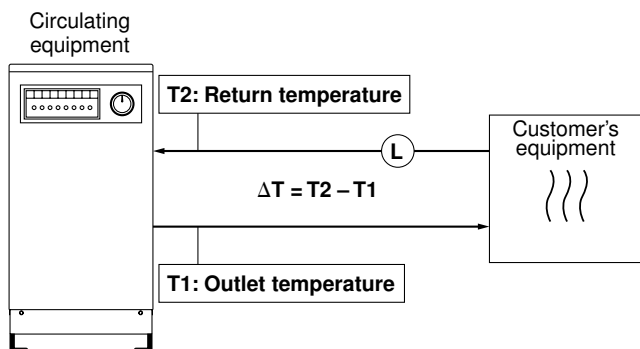

HRG
HRGC
HRZ
HRW
HEC
HEB
HED
Technical Data
Related Products

Model Selection

Calculation of Required Cooling Capacity

Example 3. When there is no heat generation, and when cooling the object below a certain temperature and period of time.

Total volume of the object being cooled down V : 60 ℓ
 Cooling time h : 15 min
 Cooling temperature difference ΔT: (20°C (20 K)
 Circulating fluid : Fluorinated fluid
 Density γ: 1.80 x 10³ kg/m³
 Specific heat C: 0.96 x 10³ J/(kg·K) (at 20°C)

* Refer to page 79 for the typical physical property values by circulating fluid.

$$Q = \frac{\Delta T \times V \times \gamma \times C}{h \times 60 \times 1000}$$

$$= \frac{20 \times 60 \times 1.80 \times 10^3 \times 0.96 \times 10^3}{15 \times 60 \times 1000}$$

$$= 2304 \text{ W} = 2.3 \text{ kW}$$

Cooling capacity = Considering a safety factor of 20%,

$$2.3 \times 1.2 = \mathbf{2.8 \text{ kW (When the circulating fluid temperature is 20°C.)}}$$

(In this case, selected Thermo-chiller model will be either HRZ002-L or HRZ004-H.)

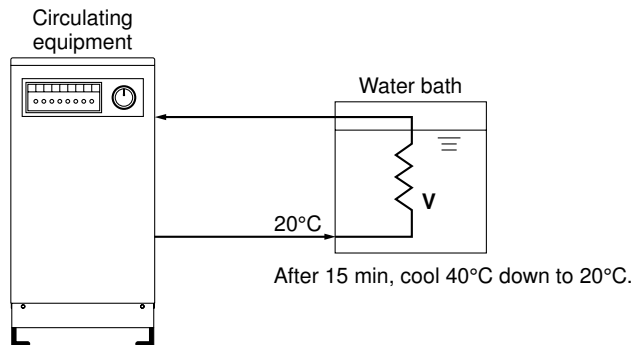

Note) This is the calculated value by changing the fluid temperature only. Thus, it varies substantially depending on the water bath or piping material or shape.

Precautions on Model Selection

1. Heating capacity

When setting the circulating fluid temperature at a higher temperature than the room temperature, the circulating fluid temperature will be heated with the Thermo-chiller. Heating capacity varies depending on the model of the HRZ series. Also, the heating capacity varies depending on the circulating fluid temperature. Consider the heat radiation amount or thermal capacity of the customer's equipment. Confirm beforehand if the required heating capacity is provided, based on the heating capacity graph for the respective model.

2. Pump capacity

<Circulating fluid flow>

Pump capacity varies depending on the model selected from the HRZ series. Also, circulating fluid flow varies depending on the circulating fluid discharge pressure. Consider the installation height difference between our Thermo-chiller and a customer's equipment, and the piping resistance such as circulating fluid pipings, or piping size, or piping curves in the equipment. Confirm beforehand if the required flow is achieved using the pump capacity curves for each respective model.

<Circulating fluid discharge pressure>

Circulating fluid discharge pressure has the possibility to increase up to the maximum pressure in the pump capacity curves for the respective model. Confirm beforehand if the circulating fluid pipings or circulating fluid circuit of the customer's equipment are fully durable against this pressure.

Example of the conventional measurement units (Reference)

0.06 m³
 0.25 h
 20°C
 Fluorinated fluid
 Density γ: 1.80 x 10³ kg/m³
 Specific heat C: 0.23 kcal/kg·°C (at 20°C)

* Refer to page 79 for the typical physical property values by circulating fluid.

$$Q = \frac{\Delta T \times V \times \gamma \times C}{h \times 860}$$

$$= \frac{20 \times 0.06 \times 1.80 \times 10^3 \times 0.23}{0.25 \times 860}$$

$$= 2.3 \text{ kW}$$

Cooling capacity = Considering a safety factor of 20%,

$$2.3 \times 1.2 = \mathbf{2.8 \text{ kW (When the circulating fluid temperature is 20°C.)}}$$

(In this case, selected Thermo-chiller model will be either HRZ002-L or HRZ004-H.)

Circulating Fluid Typical Physical Property Values

* The above shown are reference values.
Please contact circulating fluid manufacturers for details.

Fluorinated Fluids

Physical property value Temperature	Density γ	Specific heat C	
	[kg/m ³] [g/l]	[J/(kg·K)]	([kcal/kg·°C])
-10°C	1.87 x 10 ³	0.87 x 10 ³	(0.21)
20°C	1.80 x 10 ³	0.96 x 10 ³	(0.23)
50°C	1.74 x 10 ³	1.05 x 10 ³	(0.25)
80°C	1.67 x 10 ³	1.14 x 10 ³	(0.27)

Aqueous Solution of 60% Ethylene Glycol

Physical property value Temperature	Density γ	Specific heat C	
	[kg/m ³] [g/l]	[J/(kg·K)]	([kcal/kg·°C])
-10°C	1.10 x 10 ³	3.02 x 10 ³	(0.72)
20°C	1.08 x 10 ³	3.15 x 10 ³	(0.75)
50°C	1.06 x 10 ³	3.27 x 10 ³	(0.78)
80°C	1.04 x 10 ³	3.40 x 10 ³	(0.81)

Water

Density γ : 1 x 10³ [kg/m³] [g/l]

Specific heat C: 4.2 x 10³ [J/(kg·K)] (1.0 [kcal/kg·°C])

HRG
HRGC
HRZ
HRW
HEC
HEB
HED
Technical Data
Related Products

Thermo-chiller **Fluorinated Fluid Type**

Series **HRZ**

How to Order

Fluorinated Fluid Type HRZ **001** - **L** - **□**

Cooling capacity

Symbol	Cooling capacity
001	1 kW
002	2 kW
004	4 kW
008	8 kW

Temperature range setting

Symbol	Temperature range setting	1 kW	2 kW	4 kW	8 kW
L	-20 to 40°C	●	●	●	●
H	20 to 90°C	●	●	●	●
W	-20 to 90°C	—	●	—	●

Option (Refer to pages 98 and 99.)

Nil	None
C	Analog communication
D	DeviceNet™ communication
N	NPT fittings
Z	Circulating fluid automatic recovery

Specifications (For details, please consult our "Product Specifications" information.)

Model	HRZ001-L	HRZ002-L	HRZ004-L	HRZ008-L	HRZ001-H	HRZ002-H	HRZ004-H	HRZ008-H	HRZ002-W	HRZ008-W	
Cooling method	Water-cooled refrigeration										
Refrigerant	R404A (HFC)										
Control system	PID control										
Ambient temp./humidity <small>Note 1)</small>	Temperature: 10 to 35°C, Humidity: 30 to 70%RH										
Circulating fluid system	Circulating fluid <small>Note 2)</small>	Fluorinert™ FC-3283/GALDEN® HT135				Fluorinert™ FC-40/GALDEN® HT200				<ul style="list-style-type: none"> -20 to 40°C: Fluorinert™ FC-3283/GALDEN® HT135 20 to 90°C: Fluorinert™ FC-40/GALDEN® HT200 	
	Temp. range setting <small>Note 1)</small> (°C)	-20 to 40				20 to 90				-20 to 90	
	Cooling capacity <small>Note 3)</small> (kW)	1.0 (at -10°C)	2.0 (at -10°C)	4.0 (at -10°C)	8.0 (at -10°C)	1.0 (at 20°C)	2.0 (at 20°C)	4.0 (at 20°C)	8.0 (at 20°C)	2.0 (at 20°C)	8.0 (at 20°C)
	Heating capacity <small>Note 3)</small> (kW)	2.8 (at -10°C)	3.2 (at -10°C)	3.6 (at -10°C)	5.9 (at -10°C)	2.3 (at 20°C)	2.6 (at 20°C)	2.8 (at 20°C)	3.0 (at 20°C)	2.3 (at 20°C)	3.3 (at 20°C)
	Temp. stability <small>Note 4)</small> (°C)	±0.1									
	Pump capacity <small>Note 5)</small> (50/60 Hz) (MPa)	0.45/0.65 (at 20 ℓ/min)			0.65/0.95 (at 30 ℓ/min)	0.40/0.60 (at 20 ℓ/min)			0.45/0.65 (at 20 ℓ/min)		
	Rated flow <small>Note 6)</small> (ℓ/min)	20			30	20					
	Main tank capacity <small>Note 7)</small> (ℓ)	Approx. 15			Approx. 22	Approx. 12			Approx. 15		
	Sub-tank capacity <small>Note 8)</small> (ℓ)	Approx. 16			Approx. 17	Approx. 15			Approx. 16		
	Port size	Rc 3/4									
Wetted parts material	Stainless steel, EPDM, Copper brazing (Heat exchanger), PPS, Silicone, Fluororesin										
Cooling water system	Temperature range (°C)	10 to 25									
	Pressure range (MPa)	0.3 to 0.7									
	Required flow <small>Note 9)</small> (50/60 Hz) (ℓ/min)	5/5	6/6	15/22	18/23	3/4	5/6	9/10	13/14	6/7	13/14
	Port size	Rc 1/2									
Wetted parts material	Stainless steel, EPDM, Copper brazing (Heat exchanger), Silicone, Brass										
Electrical system	Power supply	3-phase 200 VAC 50 Hz, 3-phase 200 to 208 VAC 60 Hz Allowable voltage fluctuation ±10%									
	Breaker capacity (A)	30			60	20			30		
	Rated current (A)	20		25	46	14			23		
	Alarm	Refer to page 94.									
	Communications	Contact input/output (D-sub 25 pin) and Serial RS-485 (D-sub 9 pin) (Refer to pages 92 and 93.)									
Mass <small>Note 10)</small> (kg)	170		175	275	145			170			
Safety standards	UL, CE marking, SEMI (S2-0703, S8-0701, F47-0200), SEMATECH (S2-93, S8-95)										

Note 1) It should have no condensation.

Note 2) Fluorinert™ is a trademark of 3M and GALDEN® is a registered trademark of Solvay Solexis, Inc. Regarding the fluid other than the above, please contact SMC.

Note 3) (1) Facility water temperature: 25°C, (2) Circulating fluid flow rate: Values at circulating fluid rated flow rate. Values common for 50/60 Hz.

Note 4) Thermo-cooler specifications do not have heating capability.

Note 5) Capacity of the Thermo-chiller outlet when the circulating fluid temperature is at 20°C.

Note 6) Required flow for cooling capacity or maintaining the temperature stability. When used below the rated flow, use the individually sold, "By-pass piping set" (Refer to page 95).

Note 7) Minimum volume required for operating only the Thermo-chiller. (Circulating fluid temperature: 20°C, including the Thermo-chiller's internal pipings or heat exchanger)

Note 8) Preliminary space volume without main tank capacity. Available for collecting the circulating fluid inside an external piping or for preliminary injection.

Note 9) Required flow when a load is applied as shown in the cooling capacity when the facility water temperature is at 25°C.

Note 10) Mass in the dry state without circulating fluids.

Cooling Capacity

HRZ001-L/002-L/004-L/008-L

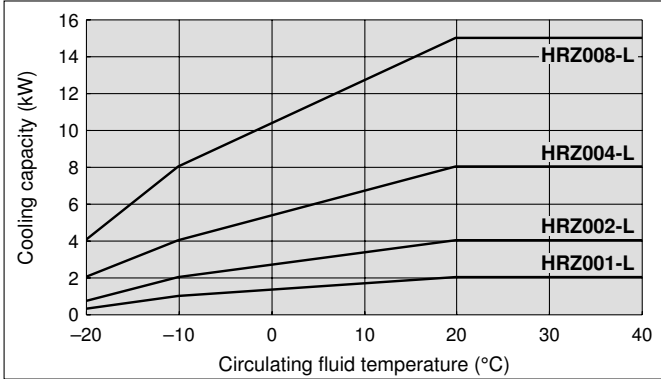

HRZ001-H/002-H/004-H/008-H

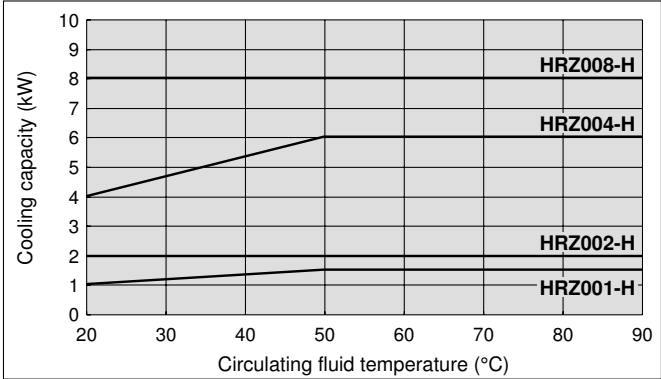

HRZ002-W/008-W

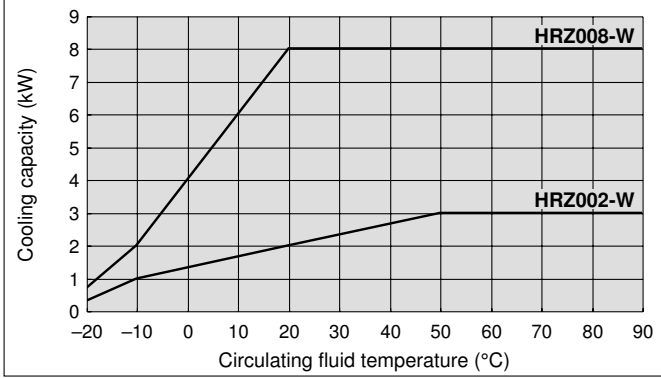

Heating Capacity

HRZ001-L/002-L/004-L/008-L

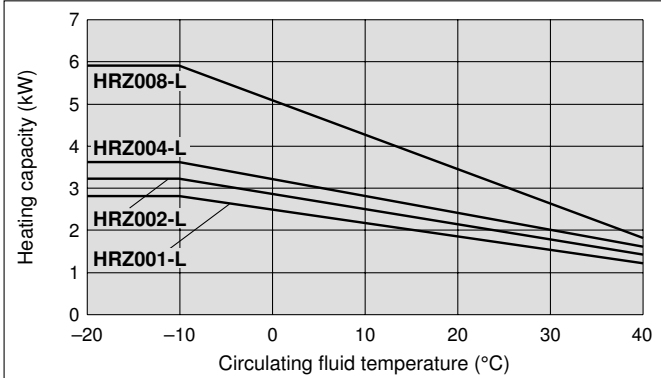

HRZ001-H/002-H/004-H/008-H

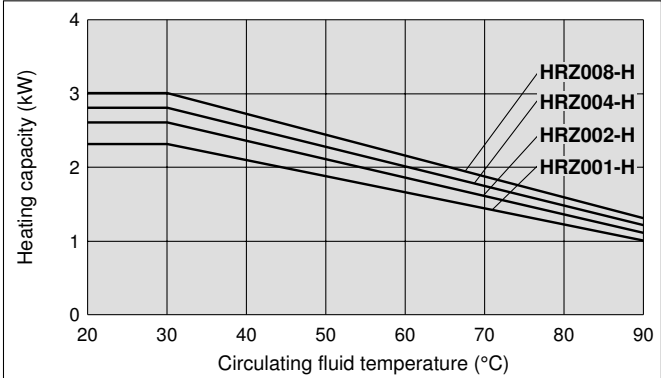

HRZ002-W/008-W

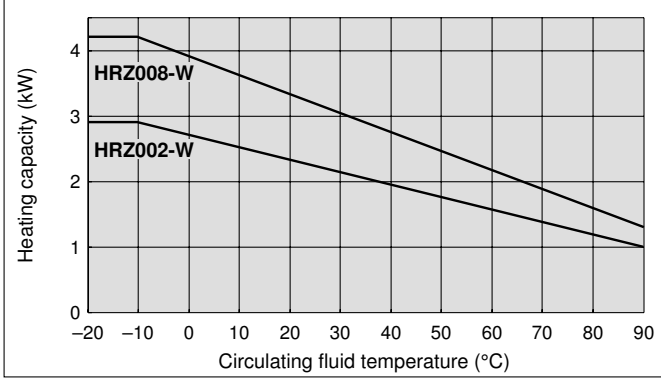

HRG
HRGC
HRZ
HRW
HEC
HEB
HED
Technical Data
Related Products

Series HRZ

Pump Capacity (Thermo-chiller Outlet)

HRZ001-L/002-L/004-L

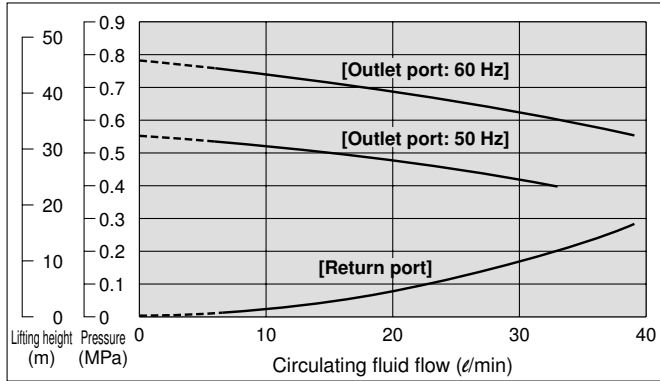

HRZ008-L

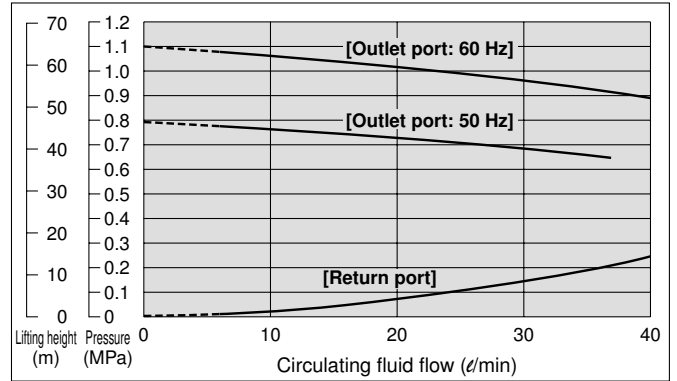

HRZ001-H/002-H

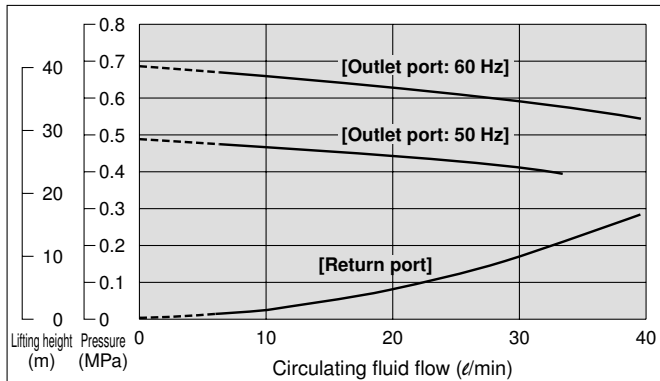

HRZ004-H/008-H HRZ002-W/008-W

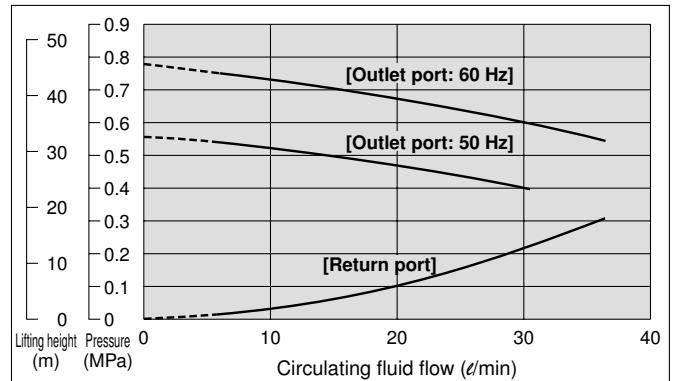

* When the circulating fluid flow is below 6 l/min, the in-built operation stop alarm will be activated. It is not possible to run the equipment. (common for all models)

Thermo-chiller Ethylene Glycol Type

Series HRZ

How to Order

Ethylene Glycol Type

HRZ 001 - L 1 - []

Cooling capacity

Symbol	Cooling capacity
001	1 kW
002	2 kW
004	4 kW
008	8 kW

Temperature range setting

Symbol	Temperature range setting	1 kW	2 kW	4 kW	8 kW
L	-20 to 40°C	●	●	●	●
H	20 to 90°C	●	●	●	●
W	-20 to 90°C	—	●	—	●

Option (Refer to pages 98 and 99.)

Nil	None
C	Analog communication
D	DeviceNet™ communication
N	NPT fittings
Y	DI control kit
Z	Circulating fluid automatic recovery

Ethylene glycol type

Specifications (For details, please consult our "Product Specifications" information.)

Model	HRZ001-L1	HRZ002-L1	HRZ004-L1	HRZ008-L1	HRZ001-H1	HRZ002-H1	HRZ004-H1	HRZ008-H1	HRZ002-W1	HRZ008-W1	
Cooling method	Water-cooled refrigeration										
Refrigerant	R404A (HFC)										
Control system	PID control										
Ambient temp./humidity ^{Note 1)}	Temperature: 10 to 35°C, Humidity: 30 to 70%RH										
Circulating fluid system	Circulating fluid ^{Note 2)}	Aqueous solution of 60% ethylene glycol									
	Temp. range setting ^{Note 1) (°C)}	-20 to 40				20 to 90				-20 to 90	
	Cooling capacity ^{Note 3) (kW)}	1.0 (at -10°C)	2.0 (at -10°C)	4.0 (at -10°C)	8.0 (at -10°C)	1.0 (at 20°C)	2.0 (at 20°C)	4.0 (at 20°C)	8.0 (at 20°C)	2.0 (at 20°C)	8.0 (at 20°C)
	Heating capacity ^{Note 3) (kW)}	2.5 (at -10°C)	2.9 (at -10°C)	3.4 (at -10°C)	6.1 (at -10°C)	1.8 (at 20°C)	2.1 (at 20°C)	2.5 (at 20°C)	3.0 (at 20°C)	2.2 (at 20°C)	3.3 (at 20°C)
	Temp. stability ^{Note 4) (°C)}	±0.1									
	Pump capacity ^{Note 5) (50/60 Hz) (MPa)}	0.25/0.40 (at 20 l/min)				0.25/0.35 (at 20 l/min)				0.25/0.40 (at 20 l/min)	
	Rated flow ^{Note 6) (l/min)}	20									
	Main tank capacity ^{Note 7) (l)}	Approx. 15			Approx. 22	Approx. 12			Approx. 15		
	Sub-tank capacity ^{Note 8) (l)}	Approx. 16			Approx. 17	Approx. 15			Approx. 16		
	Port size	Rc 3/4									
Wetted parts material	Stainless steel, EPDM, Copper brazing (Heat exchanger), PPS, Silicone, Fluororesin										
Cooling water system	Temperature range (°C)	10 to 25									
	Pressure range (MPa)	0.3 to 0.7									
	Required flow ^{Note 9) (50/60 Hz) (l/min)}	5/5	6/6	15/22	18/23	3/4	5/6	9/10	13/14	5/7	13/14
	Port size	Rc 1/2									
Electrical system	Wetted parts material	Stainless steel, EPDM, Copper brazing (Heat exchanger), Silicone, Brass									
	Power supply	3-phase 200 VAC 50 Hz, 3-phase 200 to 208 VAC 60 Hz Allowable voltage fluctuation ±10%									
	Breaker capacity (A)	30			60	20			30		
	Rated current (A)	19		26	46	14			23		
	Alarm	Refer to page 94.									
Communications	Contact input/output (D-sub 25 pin) and Serial RS-485 (D-sub 9 pin) (Refer to pages 92 and 93.)										
Mass ^{Note 10) (kg)}	170		175	275	145			170			
Safety standards	UL, CE marking, SEMI (S2-0703, S8-0701, F47-0200), SEMATECH (S2-93, S8-95)										

Note 1) It should have no condensation.

Note 2) Dilute pure ethylene glycol with clear water. Additives such as antiseptics cannot be used.

Note 3) (1) Facility water temperature: 25°C, (2) Circulating fluid flow rate: Values at circulating fluid rated flow rate. Values common for 50/60 Hz.

Note 4) Value with a stable load without turbulence in the operating conditions. It may be out of this range when a DI control kit (Option "Y") is used or in some other operating conditions.

Note 5) Capacity of the Thermo-chiller outlet when the circulating temperature is at 20°C.

Note 6) Required flow for cooling capacity or maintaining the temperature stability. When used below the rated flow, use the individually sold, "By-pass piping set" (Refer to page 95).

Note 7) Minimum volume required for operating only the Thermo-chiller. (Circulating fluid temperature: 20°C, including the Thermo-chiller's internal pipings or heat exchanger)

Note 8) Preliminary space volume without main tank capacity. Available for collecting the circulating fluid inside an external piping or for preliminary injection.

Note 9) Required flow when a load is applied as shown in the cooling capacity when the facility water temperature is at 25°C.

Note 10) Mass in the dry state without circulating fluids.

Series HRZ

Cooling Capacity

HRZ001-L1/002-L1/004-L1/008-L1

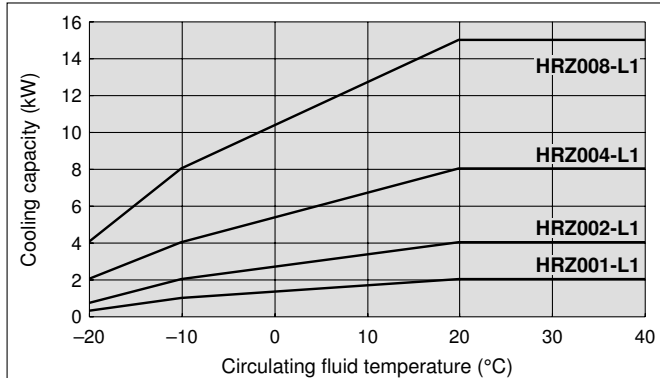

HRZ001-H1/002-H1/004-H1/008-H1

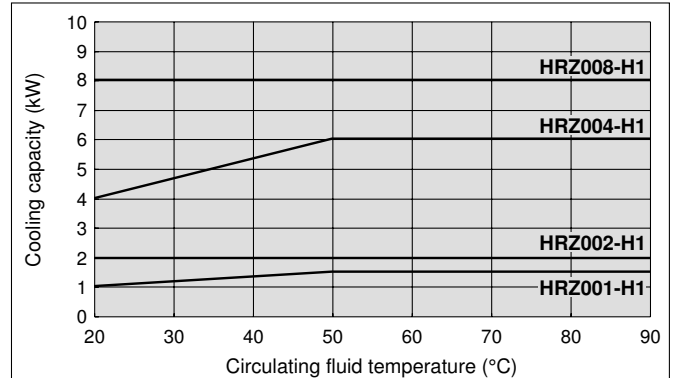

HRZ002-W1/008-W1

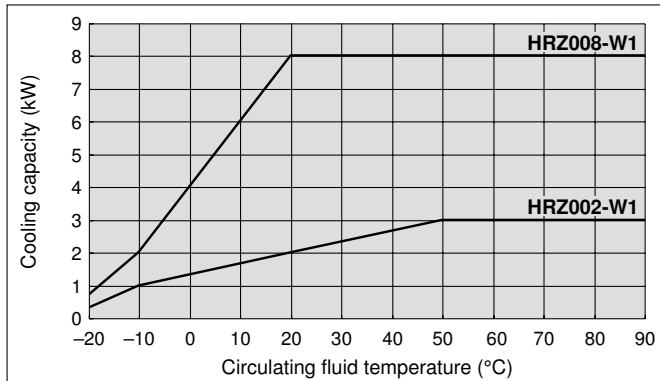

Heating Capacity

HRZ001-L1/002-L1/004-L1/008-L1

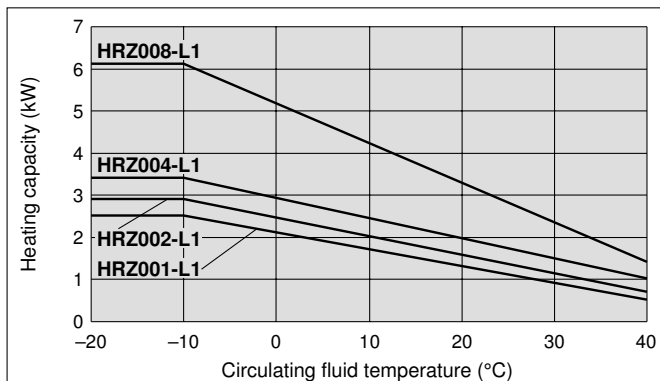

HRZ001-H1/002-H1/004-H1/008-H1

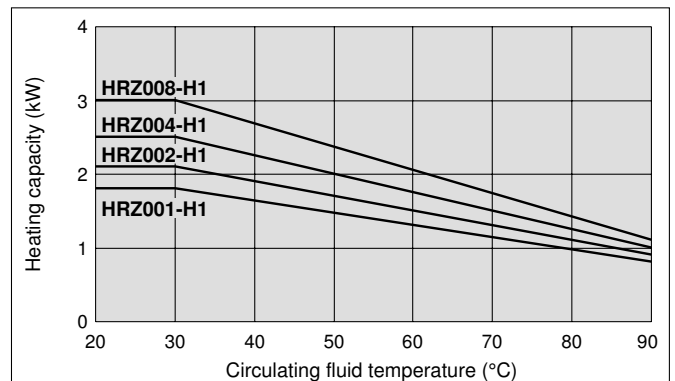

HRZ002-W1/008-W1

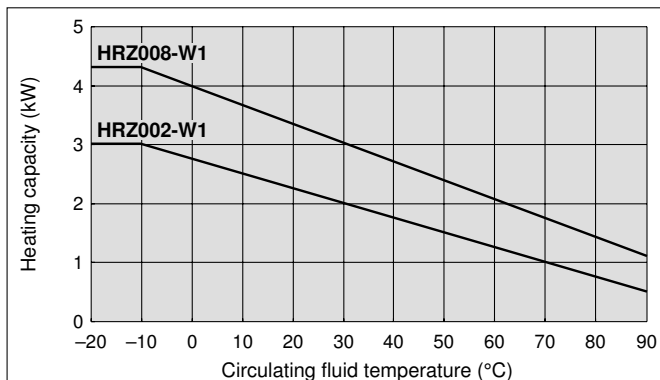

Pump Capacity (Thermo-chiller Outlet)

HRZ001-L1/002-L1/004-L1

HRZ004-H1/008-H1

HRZ002-W1/008-W1

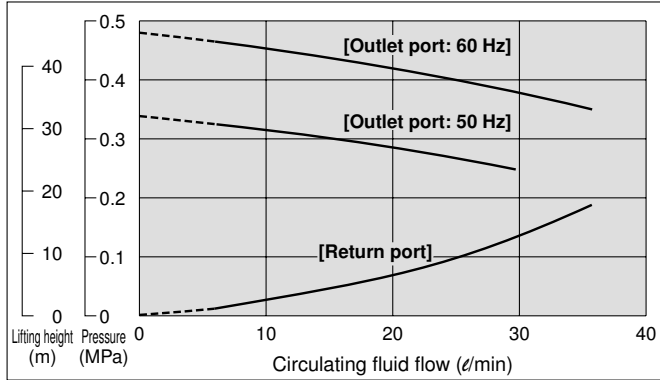

HRZ008-L1

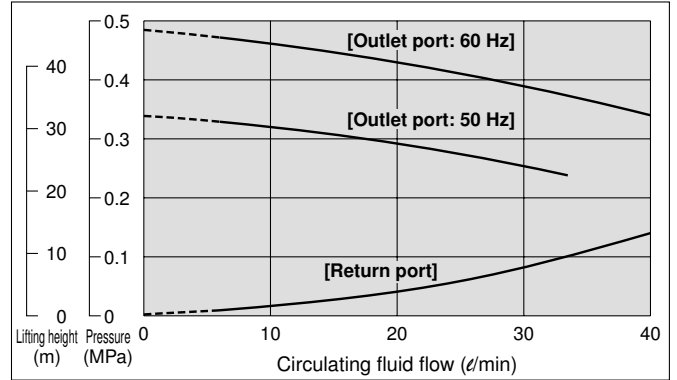

HRZ001-H1/002-H1

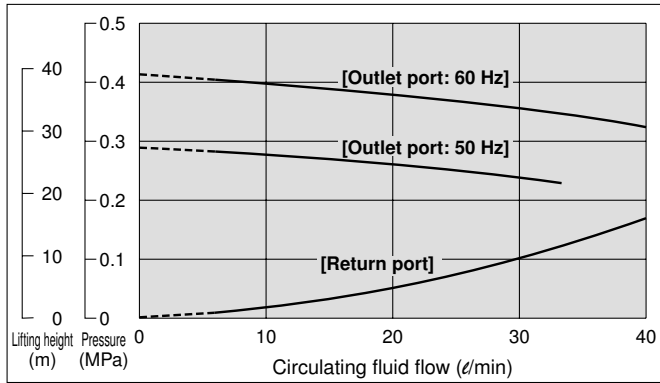

* When the circulating fluid flow is below 6 l/min, the in-built operation stop alarm will be activated. It is not possible to run the equipment. (common for all models)

HRG
HRGC
HRZ
HRW
HEC
HEB
HED
Technical Data
Related Products

Thermo-chiller **Clear/Deionized Water Type**

Series **HRZ**

How to Order

Clear/Deionized Water Type **HRZ 001 - L 2 -**

Cooling capacity

Symbol	Cooling capacity
001	1 kW
002	2 kW
004	4 kW
008	8 kW

Option (Refer to pages 98 and 99.)

Nil	None
C	Analog communication
D	DeviceNet™ communication
N	NPT fittings
Y	DI control kit
Z	Circulating fluid automatic recovery

Temperature range setting

Symbol	Temperature range setting	1 kW	2 kW	4 kW	8 kW
L	10 to 40°C	●	●	●	●

● **Clear/Deionized water type**

Specifications (For details, please consult our "Product Specifications" information.)

Model	HRZ001-L2	HRZ002-L2	HRZ004-L2	HRZ008-L2	
Cooling method	Water-cooled refrigeration				
Refrigerant	R134a (HFC)				
Control system	PID control				
Ambient temperature/humidity <small>Note 1)</small>	Temperature: 10 to 35°C, Humidity: 30 to 70%RH				
Circulating fluid system	Circulating fluid <small>Note 2)</small>	Clear water, Deionized water			
	Temperature range setting <small>Note 1)</small> (°C)	10 to 40			
	Cooling capacity <small>Note 3)</small> (kW)	1.0 (at 20°C)	2.0 (at 20°C)	4.0 (at 20°C)	8.0 (at 20°C)
	Heating capacity <small>Note 3)</small> (kW)	0.90 (at 20°C)	0.98 (at 20°C)	1.15 (at 20°C)	1.25 (at 20°C)
	Temperature stability <small>Note 4)</small> (°C)	±0.1			
	Pump capacity <small>Note 5)</small> (50/60 Hz) (MPa)	0.25/0.38 (at 20 ℓ/min)			
	Rated flow <small>Note 6)</small> (ℓ/min)	20			
	Main tank capacity <small>Note 7)</small> (ℓ)	Approx. 15			
	Sub-tank capacity <small>Note 8)</small> (ℓ)	Approx. 16			
	Port size	Rc 3/4			
Wetted parts material	Stainless steel, EPDM, Copper brazing (Heat exchanger), PPS, Silicone, Fluororesin				
Cooling water system	Temperature range (°C)	10 to 25			
	Pressure range (MPa)	0.3 to 0.7			
	Required flow <small>Note 9)</small> (50/60 Hz) (ℓ/min)	5/5	6/6	15/22	18/23
Electrical system	Port size	Rc 1/2			
	Wetted parts material	Stainless steel, EPDM, Copper brazing (Heat exchanger), Silicone, Brass			
	Power supply	3-phase 200 VAC 50 Hz, 3-phase 200 to 208 VAC 60 Hz Allowable voltage fluctuation ±10%			
	Breaker capacity (A)	30			
	Rated current (A)	19			
Alarm	Refer to page 94.				
Communications	Contact input/output (D-sub 25 pin) and Serial RS-485 (D-sub 9 pin) (Refer to pages 92 and 93.)				
Mass <small>Note 10)</small> (kg)	170				
Safety standards	UL, CE marking, SEMI (S2-0703, S8-0701, F47-0200), SEMATECH (S2-93, S8-95)				

Note 1) It should have no condensation.

Note 2) If clear water or deionized water is used, it should be in accordance with the Water Quality Standard of the Japan Refrigeration and Air Conditioning Industry Association (JRA GL-02-1994/cooling water system - circulation type - make-up water). The minimum electrical conductivity of the deionized water used as the fluid should be 0.5 μs/cm (or the electrical resistivity 2.0 MΩ·cm at maximum).

Note 3) (1) Facility water temperature: 25°C, (2) Circulating fluid flow rate: Values at circulating fluid rated flow rate. Values common for 50/60 Hz.

Note 4) Value with a stable load without turbulence in the operating conditions. It may be out of this range when a DI control kit (Option "Y") is used or in some other operating conditions.

Note 5) Capacity of the outlet of a Thermo-chiller outlet when the circulating fluid temperature is at 20°C.

Note 6) Required flow for cooling capacity or maintaining the temperature stability. When used below the rated flow, use the individually sold, "By-pass piping set" (Refer to page 95).

Note 7) Minimum volume required for operating only the Thermo-chiller. (Circulating fluid temperature: 20°C, including the Thermo-chiller's internal pipings or heat exchanger)

Note 8) Preliminary space volume without main tank capacity. Available for collecting the circulating fluid inside an external piping or for preliminary injection.

Note 9) Required flow when a load is applied as shown in the cooling capacity when the facility water temperature is at 25°C.

Note 10) Mass in the dry state without circulating fluids.

Cooling Capacity

HRZ001-L2/002-L2/004-L2/008-L2

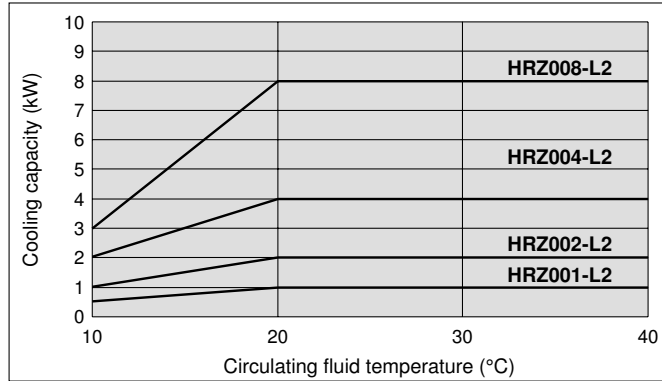

Heating Capacity

HRZ001-L2/002-L2/004-L2/008-L2

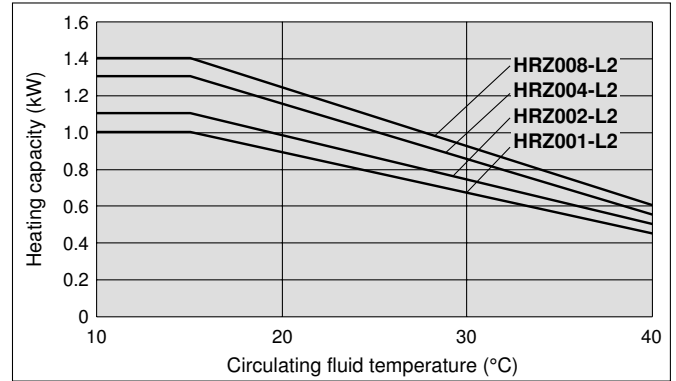

Pump Capacity (Thermo-chiller Outlet)

HRZ001-L2/002-L2/004-L2/008-L2

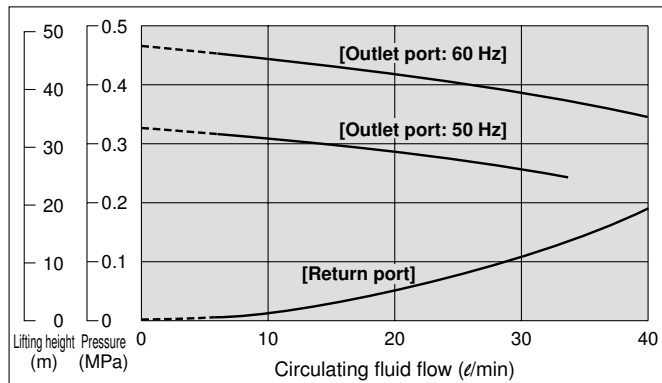

* When the circulating fluid flow is below 6 l/min, the in-built operation stop alarm will be activated. It is not possible to run the equipment. (common for all models)

HRG
HRGC
HRZ
HRW
HEC
HEB
HED
Technical Data
Related Products

Thermo-chiller **Double Inverter Type**

Series **HRZ**

How to Order

Double Inverter Type **HRZ** **010** - **W** **S** - **Option**

Cooling capacity

Symbol	Cooling capacity
010	10 kW

Circulating fluid type

Symbol	Circulating fluid type	Temperature range setting
Nil	Fluorinated fluids	-20 to 90°C
1	Ethylene glycol aqueous solution	-20 to 90°C
2	Clear/Deionized water	10 to 60°C

Option (Refer to pages 98 and 99.)

Nil	None
C	Analog communication
D	DeviceNet™ communication
N	NPT fittings
Y*	DI control kit
Z	Circulating fluid automatic recovery

Double inverter type * Not equipped to the fluorinated fluid type.

Specifications

Model		HRZ010-WS	HRZ010-W1S	HRZ010-W2S
Cooling method		Water-cooled refrigeration		
Refrigerant		R404A (HFC)		
Control system		PID control		
Ambient temperature/humidity <small>Note 1)</small>		Temperature: 10 to 35°C, Humidity: 30 to 70%RH		
Circulating fluid system	Circulating fluid <small>Note 2)</small>	<ul style="list-style-type: none"> -20 to 40°C: Fluorinert™ FC-3283/GALDEN® HT135 20 to 90°C: Fluorinert™ FC-40/GALDEN® HT200 	Aqueous solution of 60% ethylene glycol	Clear water, Deionized water
	Temperature range setting <small>Note 1)</small> (°C)	-20 to 90		
	Cooling capacity <small>Note 3)</small> (kW)	10 (at 20°C)	10 (at 20°C)	9 (at 20°C)
	Heating capacity <small>Note 3)</small> (kW)	5.0 (at 20°C)	4.5 (at 20°C)	2.5 (at 20°C)
	Temperature stability <small>Note 4)</small> (°C)	±0.1 (In cases when the circulating fluid discharge port and the return port are directly connected)		
	Pump capacity <small>Note 5)</small> (MPa)	Max. 0.72 (at 20 ℓ/min)	Max. 0.40 (at 20 ℓ/min)	Max. 0.38 (at 20 ℓ/min)
	Rated flow <small>Note 6)</small> (ℓ/min)	20		
	Flow setting range <small>Note 7)</small> (ℓ/min)	10 to 40 (With flow control function by inverter)		
	Main tank capacity <small>Note 8)</small> (ℓ)	Approx. 15		
	Sub-tank capacity <small>Note 9)</small> (ℓ)	Approx. 16		
Port size	Rc 3/4			
Wetted parts material	Stainless steel, EPDM, Copper brazing (Heat exchanger), PPS, Silicone, Fluororesin			
Cooling water system	Temperature range (°C)	10 to 30		10 to 25
	Pressure range (MPa)	0.3 to 0.7		
	Required flow <small>Note 10)</small> (50/60 Hz) (ℓ/min)	15/15		
	Port size	Rc 1/2		
Wetted parts material	Stainless steel, EPDM, Copper brazing (Heat exchanger), PPS, Silicone, Brass			
Electrical system	Power supply	3-phase 200 VAC 50 Hz, 3-phase 200 to 208 VAC 60 Hz Allowable voltage fluctuation ±10%		
	Breaker capacity (A)	30		
	Rated current (A)	26	25	25
	Alarm	Refer to page 94.		
	Communications	Contact input/output (D-sub 25 pin) and Serial RS-485 (D-sub 25 pin) (Refer to pages 92 and 93.)		
	Mass <small>Note 11)</small> (kg)	165		
Safety standards	UL, CE marking, SEMI (S2-0703, S8-0701, F47-0200), SEMATECH (S2-93, S8-95)			

Note 1) It should have no condensation.

Note 2) Fluorinert™ is a trademark of 3M and GALDEN® is a registered trademark of Solvay Solexis, Inc. Dilute pure ethylene glycol with clear water. Additives such as antiseptics cannot be used. If clear water or deionized water is used, it should be in accordance with the Water Quality Standard of the Japan Refrigeration and Air Conditioning Industry Association (JRA GL-02-1994/cooling water system - circulation type - make-up water). The minimum electrical conductivity of the deionized water used as the fluid should be 0.5 μs/cm (or the electrical resistivity 2.0 MΩ·cm at maximum).

Note 3) (1) Facility water temperature: 25°C, (2) Circulating fluid flow rate: Values at circulating fluid rated flow rate. Values common for 50/60 Hz.

Note 4) Value with a stable load without turbulence in the operating conditions. It may be out of this range when a DI control kit (Option "Y") is used or in some other operating conditions.

Note 5) Capacity of the Thermo-chiller outlet when the circulating fluid temperature is at 20°C.

Note 6) Required flow for cooling capacity or maintaining the temperature stability. When used below the rated flow, use the individually sold, "By-pass piping set" (Refer to page 95).

Note 7) May not be able to control with the set value depending on the piping specification in the customer side.

Note 8) Minimum volume required for operating only the Thermo-chiller. (Circulating fluid temperature: 20°C, including the Thermo-chiller's internal pipings or heat exchanger)

Note 9) Preliminary space volume without main tank capacity. Available for collecting the circulating fluid inside an external piping or for preliminary injection.

Note 10) Required flow when a load is applied as shown in the cooling capacity when the facility water temperature is at 25°C.

Note 11) Mass in the dry state without circulating fluids.

Cooling Capacity

HRZ010-WS/010-W1S

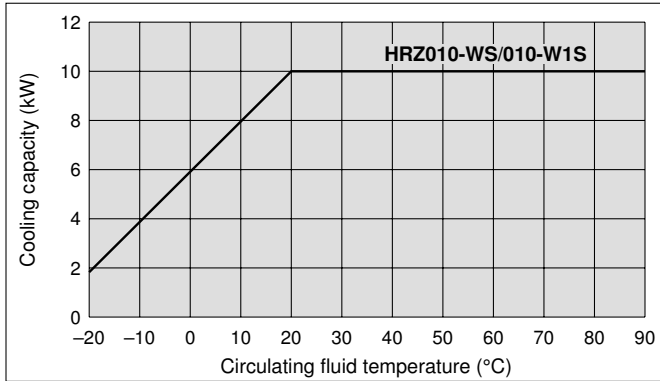

HRZ010-W2S

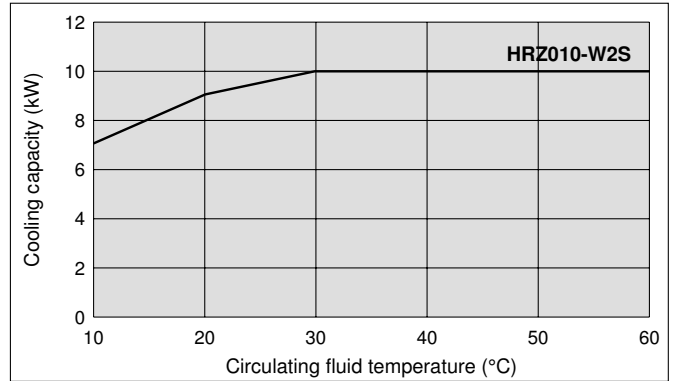

Heating Capacity

HRZ010-WS/010-W1S/010-W2S

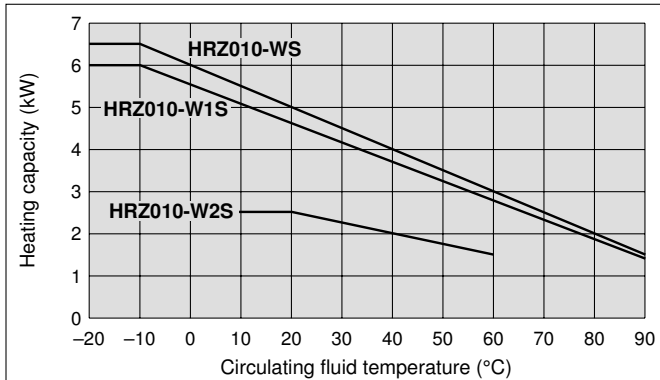

Pump Capacity (Thermo-chiller Outlet)

HRZ010-WS

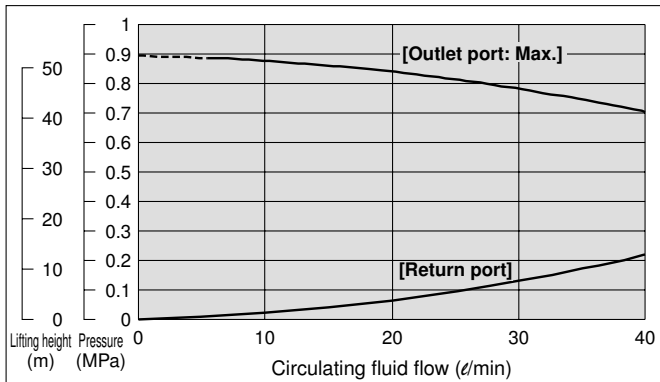

HRZ010-W1S

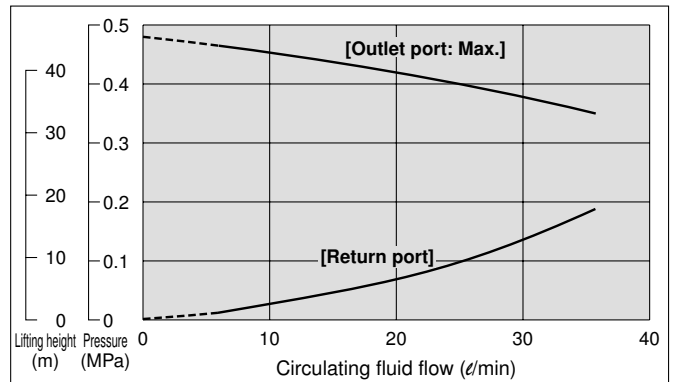

* The pump capacity of the HRZ010-W1S is same as that of the HRZ001-L1 group on page 85.
 * The pump capacity of the HRZ010-W2S is same as on page 87.

HRZ010-W2S

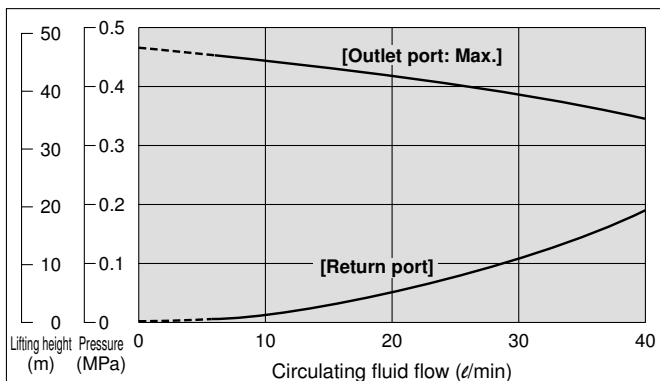

* When the circulating fluid flow is below 6 l/min, the in-built operation stop alarm will be activated. It is not possible to run the equipment. (common for all models)
 * With flow control function by inverter

HRG
 HRGC
 HRZ
 HRW
 HEC
 HEB
 HED
 Technical Data
 Related Products

Series HRZ Common Specifications

Dimensions

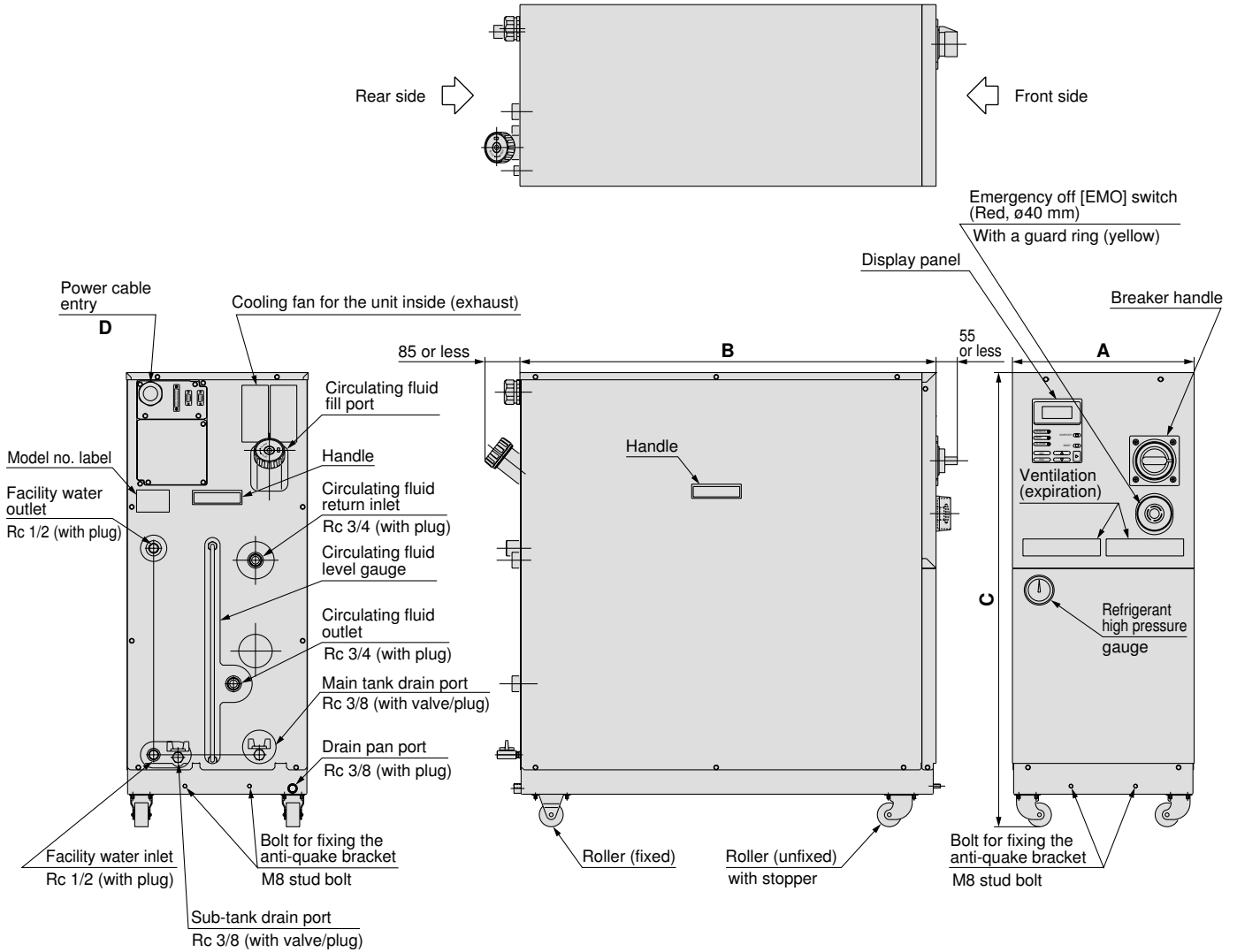

(mm)

Model			A	B	C	D
Fluorinated fluid type	Ethylene glycol type	Clear/Deionized water type				
HRZ001-H HRZ002-H	HRZ001-H1 HRZ002-H1	—	380	870	860	ø18.5 to 20.5
HRZ001-L HRZ002-L, W HRZ004-L, H HRZ008-H, W HRZ010-WS	HRZ001-L1 HRZ002-L1, W1 HRZ004-L1, H1 HRZ008-H1, W1 HRZ010-W1S	HRZ001-L2 HRZ002-L2 HRZ004-L2 HRZ008-L2 HRZ010-W2S	380	870	950	ø18.5 to 20.5

(Dimensional tolerance of A, B, and C: ±10 mm)

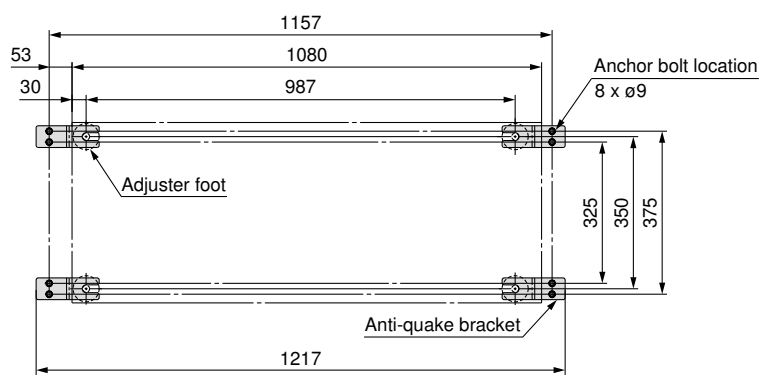
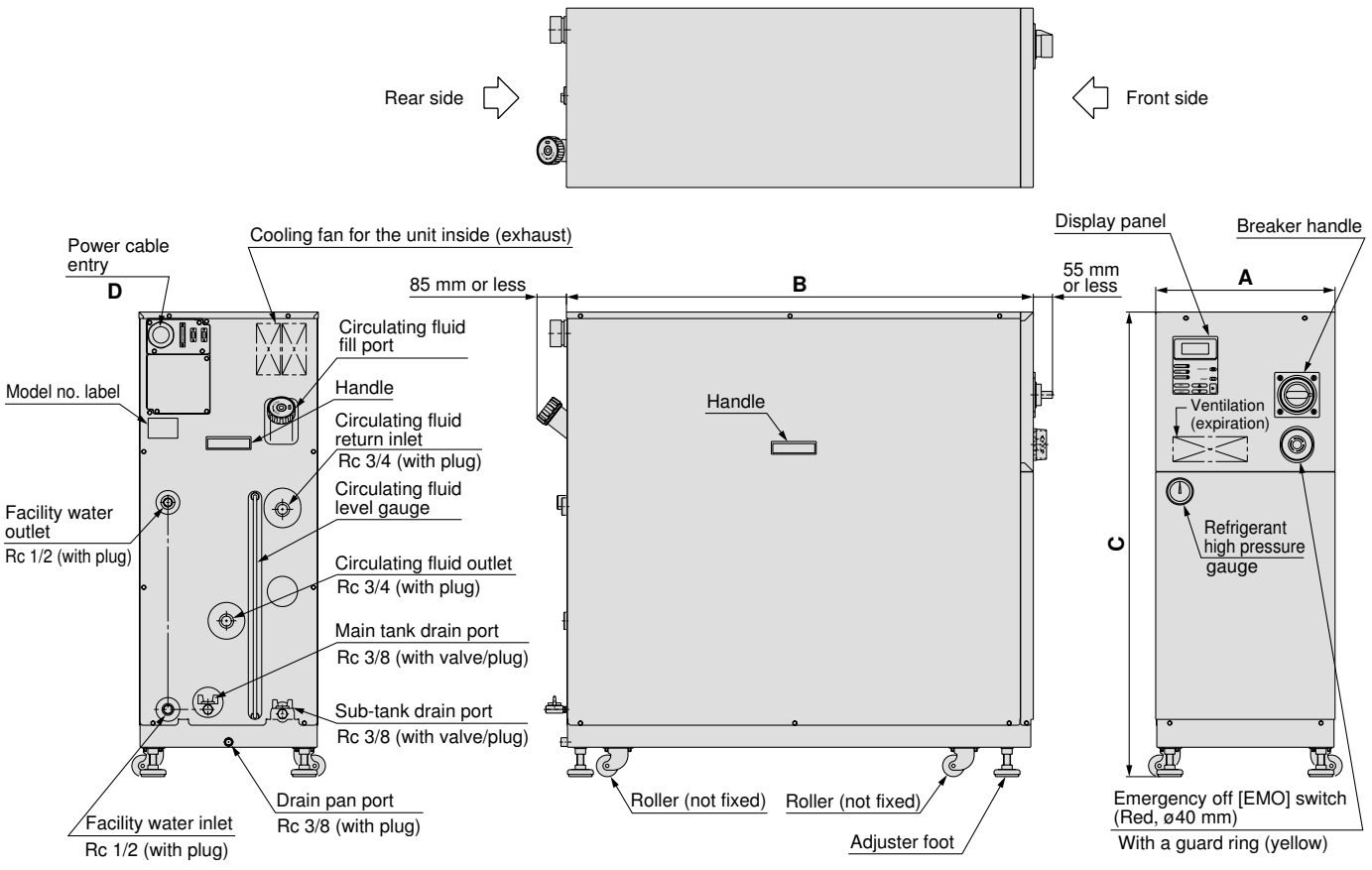

Anti-quake bracket mounting position (Dimensional tolerance: ±5 mm)

* Anchor bolts (M8, 8 pcs.) which are suitable for the floor material should be prepared by customer.

Model		A	B	C	D
Fluorinated fluid type	Ethylene glycol type				
HRZ008-L	HRZ008-L1	415	1080	1075	ø35.0 to 38.0

(Dimensional tolerance of A, B, and C: ±10 mm)

HRG
HRGC
HRZ
HRW
HEC
HEB
HED
Technical Data
Related Products

Communications (For details, please consult our "Communication Specifications" information.)

Contact Input/Output Function

Item		Specifications
Connector no.		P1 (Refer to the next page for connector location)
Connector type (on this product side)		D-sub 25 P type, Female connector
Fixing bolt size		M2.6 x 0.45
Input signal	Insulation method	Photocoupler
	Rated input voltage	24 VDC
	Operating voltage range	21.6 VDC to 26.4 VDC
	Rated input current	5 mA TYP
	Input impedance	4.7 kΩ
Open collector output signal	Insulation method	Photocoupler
	Rated load voltage	24 VDC
	Operating load voltage range	21.6 VDC to 26.4 VDC
	Maximum load current	80 mA
	Leakage current	0.1 mA or less
	Surge protection	Diode
Contact output signal (Alarm signal)	Rated load voltage	48 VAC or less / 24 VDC or less
	Maximum load current	AC/DC 500 mA (resistance load)
Contact output signal (EMO signal)	Rated load voltage	48 VAC or less / 24 VDC or less
	Maximum load current	AC/DC 800 mA (resistance load / inductive load)

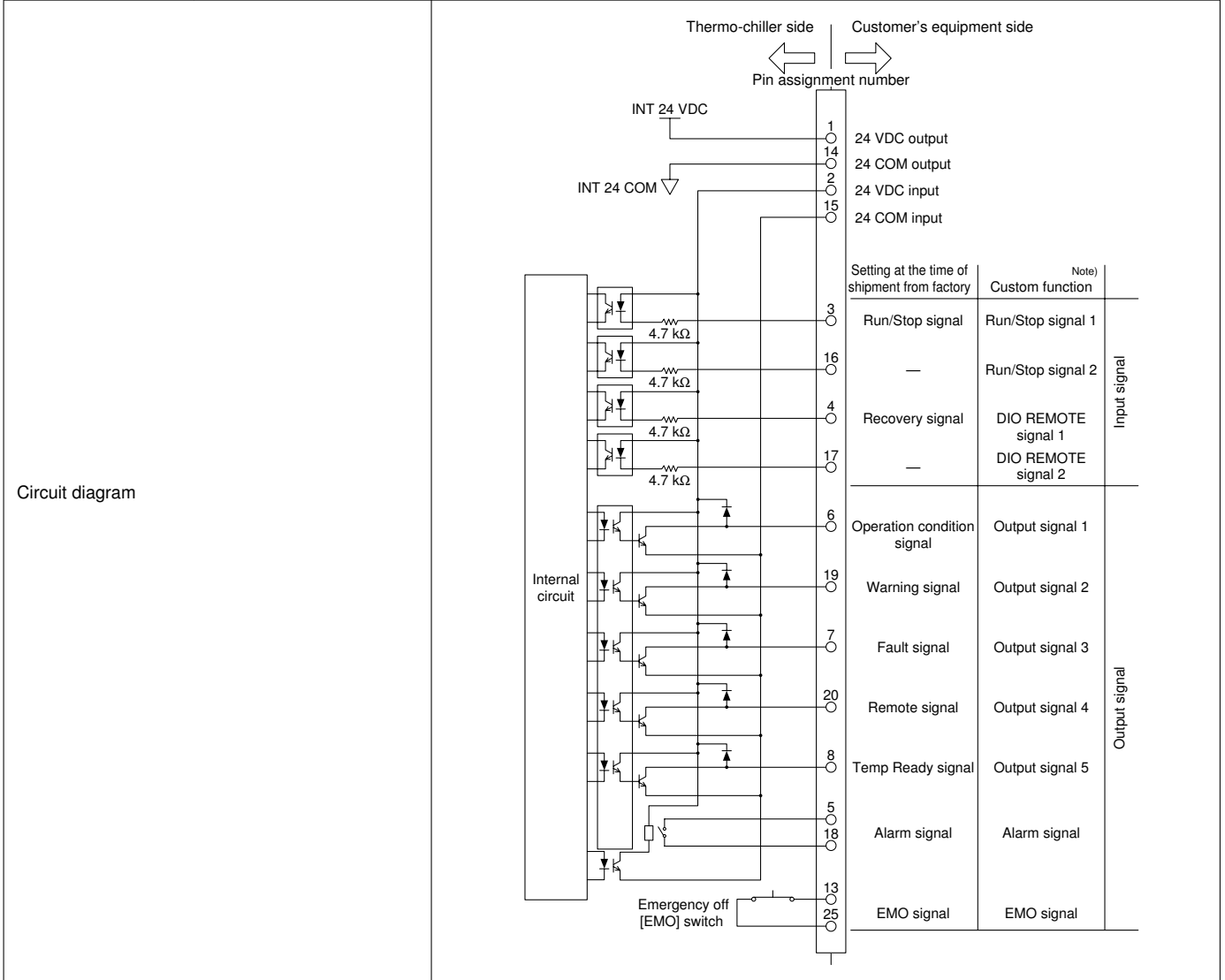

Note) The custom function is equipped for contact input/output. Using the custom function enables the customer to set the signal type for contact input/output or pin assignment numbers. For details, please consult "Communication Specifications" information.

Serial RS-485

The serial RS-485 enables the following items to be written and read out.

<Writing>

- Run/Stop
- Circulating fluid temperature setting
- Circulating fluid automatic recovery start/stop

<Readout>

- Circulating fluid present temperature
- Circulating fluid flow
- Circulating fluid discharge pressure
- Circulating fluid electrical resistivity *2
- Alarm occurrence information
- Status (operating condition) information

*1 Only when the circulating fluid automatic recovery function (Option "Z") is selected.
 *2 Only when the DI control kit (Option "Y") is selected.

Item	Specifications
Connector no.	P2
Connector type (on this product side)	D-sub 9 P type, Female connector
Fixing bolt size	M2.6 x 0.45
Standard	EIA RS485
Protocol	Modicon Modbus
Circuit diagram	

Connector location

P3: Not used for the maintenance purpose port
 D-sub9 (Male receptacle)

P2: Serial RS-485
 D-sub9 (Female receptacle)

P1: Contact input/output
 D-sub25 (Female receptacle)

Power cable entry

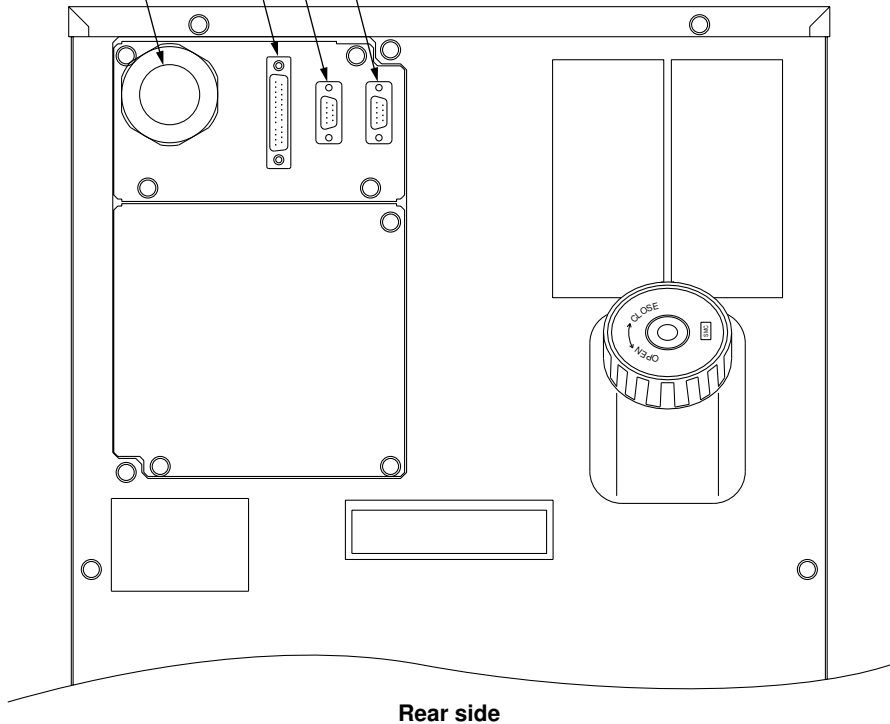

HRG
 HRGC
HRZ
 HRW
 HEC
 HEB
 HED
 Technical Data
 Related Products

Operation Panel Display

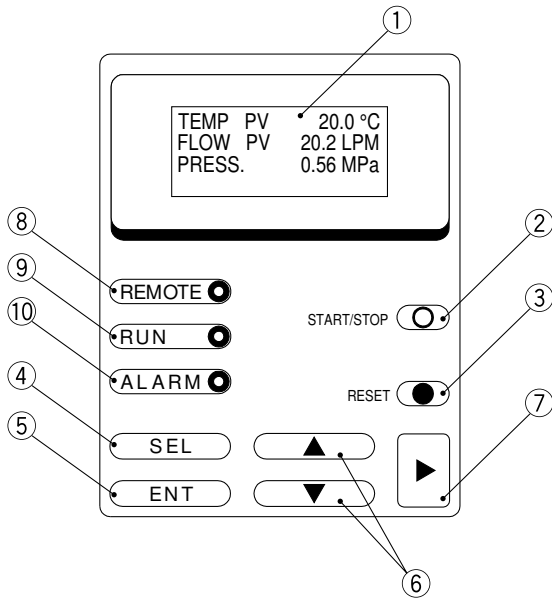

No.	Description	Function
①	LCD screen	Operating condition of this unit / Circulating fluid discharge temperature / Circulating fluid flow / Circulating fluid discharge pressure / Setting value / Alarm message, etc. are displayed.
②	(START/STOP) key	Starts/Stops the operation.
③	(RESET) key	Stops the alarm buzzing. / Resets the alarm.
④	(SEL) key	Switches the display.
⑤	(ENT) key	Decides the settings.
⑥	(▲) (▼) key	Moves the cursor and changes the setting values.
⑦	(▶) key	Moves the cursor.
⑧	(REMOTE) indicator	Lights up when the unit is in the remote status.
⑨	(RUN) indicator	Lights up when the unit is in the operating status.
⑩	(ALARM) indicator	Lights up when the unit is alarming.

Alarm

This unit can display 27 kinds of alarm messages as standard. Also, it can read out the serial RS-485 communication.

Alarm code	Alarm message	Operation status	Main reason
01	Water Leak Detect FLT	Stop	Liquid deposits in the base of this unit.
02	Incorrect Phase Error FLT	Stop	The power supply to this unit is incorrect.
03	RFGT High Press FLT	Stop	Pressure in the refrigeration circuit has exceeded the limitation.
04	CPRSR Overheat FLT	Stop	Temperature inside the refrigerator has increased.
05	Reservoir Low Level FLT	Stop	The amount of circulating fluid is running low.
06	Reservoir Low Level WRN	Continue	The amount of circulating fluid is running low.
07	Reservoir High Level WRN	Continue	Filling the circulating fluid too much.
08	Temp. Fuse Cutout FLT	Stop	Temperature of the circulating fluid tank is raised.
09	Reservoir High Temp. FLT	Stop	Temperature of the circulating fluid has exceeded the limitation.
11	Reservoir High Temp. WRN	Continue	Temperature of the circulating fluid has exceeded the limitation set by customer.
12	Return Low Flow FLT	Stop	The circulating fluid flow has gone below 6 l/min.
13	Return Low Flow WRN	Continue	The circulating fluid flow has gone below the limitation set by customer.
14	Heater Breaker Trip FLT	Stop	Protection device for the electric circuit of the heater is activated.
15	Pump Breaker Trip FLT	Stop	Protection device for the electric circuit of the circulating pump is activated.
16	CPRSR Breaker Trip FLT	Stop	Protection device for the electric circuit of the refrigerator is activated.
17	Interlock Fuse Cutout FLT	Stop	Overcurrent is flown to the control circuit.
18	DC Power Fuse Cutout WRN	Continue	Overcurrent has flowed to the (optional) solenoid valve.
19	FAN Motor Stop WRN	Continue	Cooling fan inside the refrigerator has stopped.
20	Internal Pump Time Out WRN	Continue	The internal pump continuously run for more than a certain period of time.
21	Controller Error FLT	Stop	The error occurred in the control systems.
22	Memory Data Error FLT	Stop	The data stored in the controller of this unit went wrong.
23	Communication Error WRN	Continue	The serial communications between this unit and customer's system has been suspended.
24	DI Low Level WRN	Continue	DI level of the circulating fluid has gone below the limitation set by customer. (Option)
25	Pump Inverter Error FLT	Stop	An error has occurred in the inverter for the circulating pump. The alarm is only for the HRZ010-W□S.
26	DNET Comm. Error WRN	Continue	The DeviceNet communications between this unit and customer's system has been suspended. (Only for DeviceNet communication specification - Option "D")
27	DNET Comm. Error FLT	Stop	An error has occurred in the DeviceNet communication system of this unit. (Only for DeviceNet communication specification - Option "D")
28	CPRSR INV Error FLT	Stop	An error has occurred in the inverter for the refrigerator. The alarm is only for the HRZ010-W□S.

Series HRZ

Optional Accessories

By-pass Piping Set

Note) Necessary to be fitted by customer.

When the circulating fluid goes below the rated flow, cooling capacity will be reduced and the temperature stability will be badly affected. In such a case, use the by-pass piping set.

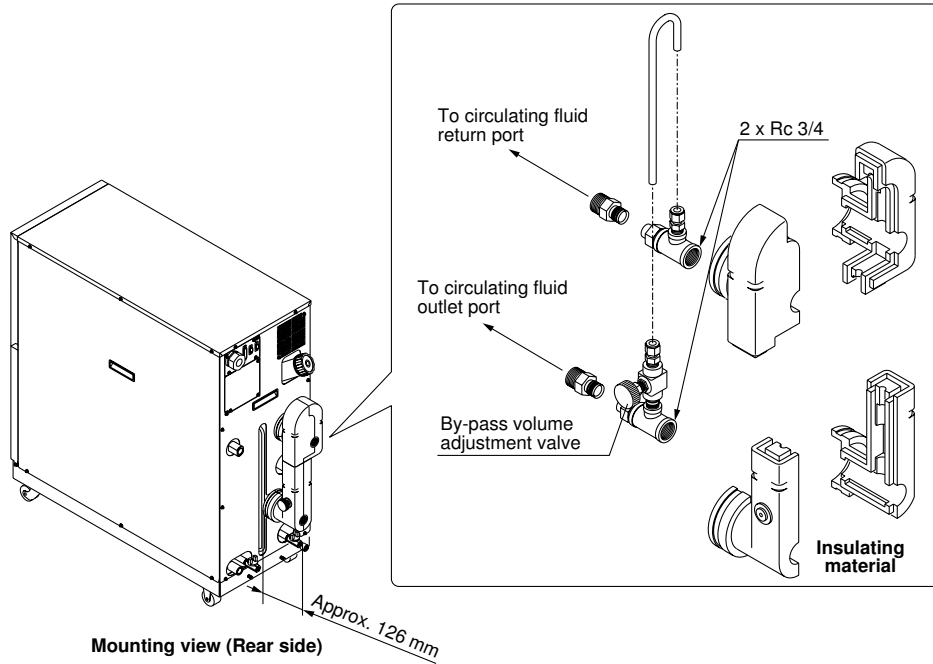

Part no.	Applicable model
HRZ-BP001	HRZ001-H/HRZ001-H1 HRZ002-H/HRZ002-H1
HRZ-BP002	HRZ001-L/HRZ001-L1 HRZ001-L2 HRZ002-L/HRZ002-L1 HRZ002-L2 HRZ004-L/HRZ004-L1 HRZ004-L2 HRZ008-L2 HRZ004-H/HRZ004-H1 HRZ008-H/HRZ008-H1 HRZ002-W/HRZ002-W1 HRZ008-W/HRZ008-W1 HRZ010-WS HRZ010-W1S HRZ010-W2S
HRZ-BP008	HRZ008-L/HRZ008-L1

Anti-quake Bracket

Bracket for earthquakes
Prepare the anchor bolts (M12) which are suited to the floor material by customer.

Part no.	Applicable model
HRZ-TK002	HRZ001-L□/HRZ002-L□/HRZ004-L□/HRZ008-L2 HRZ001-H□/HRZ002-H□ HRZ004-H□/HRZ008-H□ HRZ002-W□/HRZ008-W□/HRZ010-W□S

Note 1) 2 pieces per set (for 1 unit) (HRZ-TK-002)

Note 2) Anti-quake bracket is attached as standard. (HRZ008-L, HRZ008-L1)

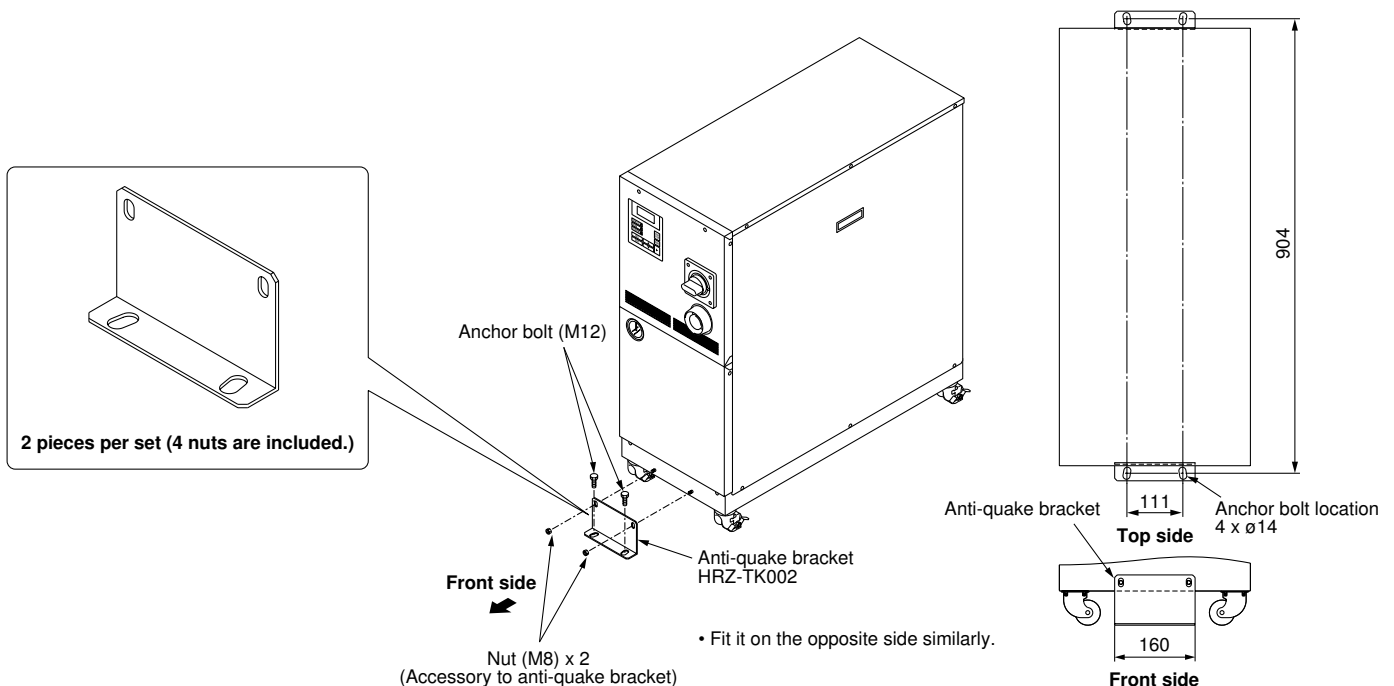

HRG

HRGC

HRZ

HRW

HEC

HEB

HED

Technical Data

Related Products

Series HRZ

4 Port Manifold

4-branching the circulating fluid enables 4 temperature controls at the maximum with the 1 unit Thermo-chiller.

Part no.	Applicable model
HRZ-MA001	Common for all models

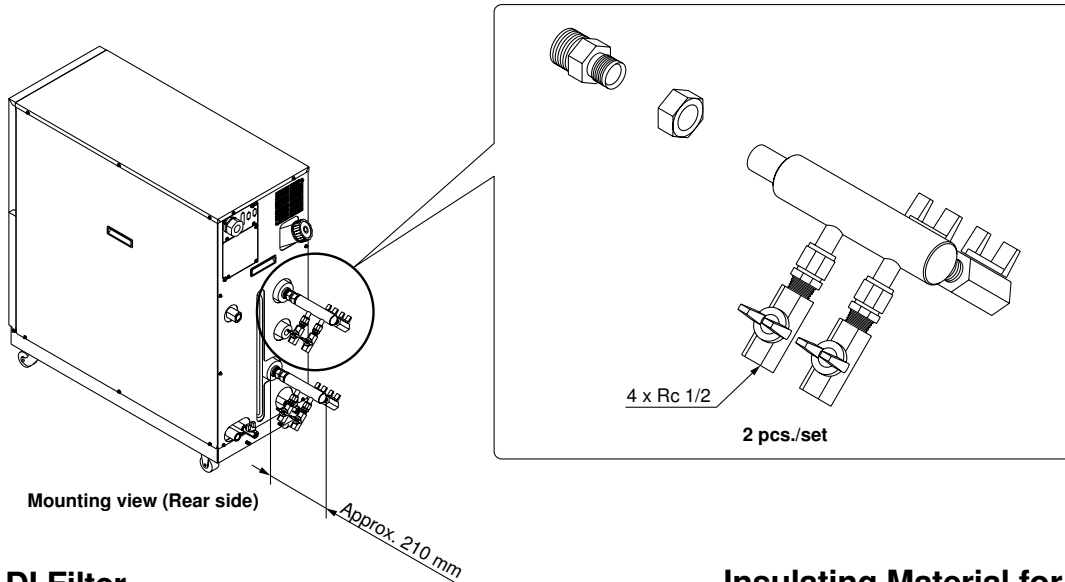

DI Filter

This is the ion replacement resin to maintain the electrical resistivity of the circulating fluid. Customers who selected the DI control kit (Option "Y") need to purchase the DI filter separately.

Part no.	Applicable model
HRZ-DF001	Common for all models which can select the DI control kit. (Option "Y")

Note) The DI filters are consumable. Depending on the status (electrical resistivity set value, circulating fluid temperature, piping volume, etc.), product life cycles will vary accordingly.

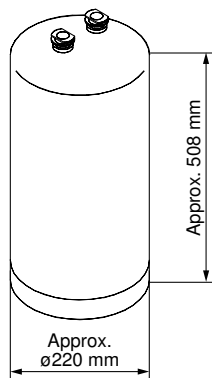

Mass: Approx. 20 kg

Insulating Material for DI Filter

When the DI filter is used at a high-temperature, we recommend that you use this insulating material to protect the radiated heat from the DI filter or possible burns. When the DI filter is used at a low-temperature, we also recommend that you use this to prevent heat absorption from the DI filter and to avoid forming condensation.

Part no.	Applicable model
HRZ-DF002	Common for all models which can select the DI control kit. (Option "Y")

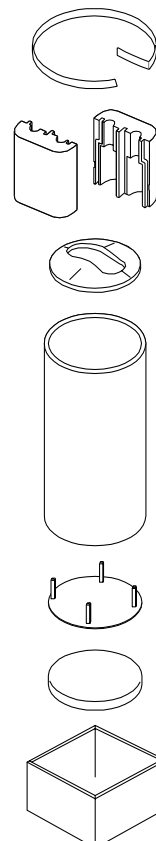

Aqueous Solution of 60% Ethylene Glycol

This solution can be used as a circulating fluid for ethylene glycol-type Thermo-chillers. (Capacity: 10 ℓ)

Part no.	Applicable model
HRZ-BR001	Common for all ethylene glycol-type models

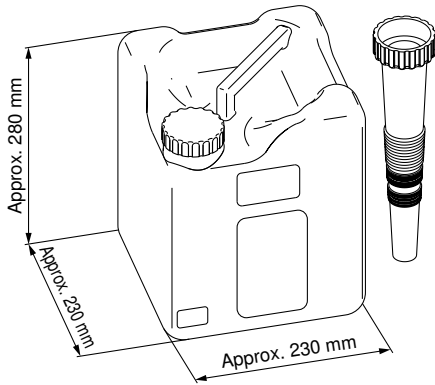

Densitometer

This meter can be used to control the condensation of ethylene glycol solution periodically.

Part no.	Applicable model
HRZ-BR002	Common for all ethylene glycol-type models

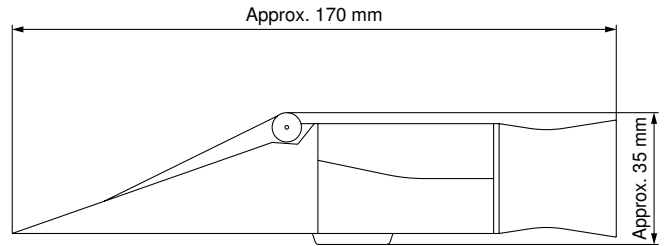

HRG

HRGC

HRZ

HRW

HEC

HEB

HED

Technical Data

Related Products

Series HRZ Options

Note) Options have to be selected when ordering the Thermo-chiller. It is not possible to add them after purchasing the unit.

C Option symbol Analog Communication

HRZ - - C

Analog communication

In addition to the standard contact input/output signal communication and the serial RS-485 communication, analog communication function can be added.

The analog communication function enables to write and read out the following items.

<Writing> Circulating fluid temperature setting	<Readout> Circulating fluid present temperature Electrical resistivity*
--	---

* Only when the DI control kit (Option "Y") is selected.

Scaling voltage - circulating fluid temperature can be set arbitrarily by customer.

For details, please consult our "Communication Specifications" information.

D Option symbol DeviceNet™ Communication

HRZ - - D

DeviceNet™ communication

DeviceNet™

In addition to the standard contact input/output signal communication and the serial RS-485 communication, DeviceNet™ function can be added. DeviceNet™ function enables to write and read out the following items.

<Writing> Run/Stop Circulating fluid temperature setting Circulating fluid automatic recovery start/stop*1	<Readout> Circulating fluid present temperature Circulating fluid flow Circulating fluid discharge pressure Electrical resistivity*2 Alarm occurrence information Status (operating condition) information
---	--

*1 Only when the circulating fluid automatic recovery function (Option "Z") is selected.

*2 Only when the DI control kit (Option "Y") is selected.

For details, please consult our "Communication Specifications" information.

N Option symbol NPT Fittings

HRZ - - N

NPT fittings

An adapter is included to change the connection parts of circulating fluid piping and facility water piping to NPT thread type. The adapter must be installed by customer.

Y Option symbol DI Control Kit

HRZ - - Y

DI control kit

Select this option if you want to maintain the electric resistance ratio (DI level) of the circulating fluid at a certain level. However, some components have to be fitted by customer. For details, refer to specification table for this option.

Please note that this is not applicable to the fluorinated liquid type.

Applicable model		HRZ00□-L1-Y HRZ00□-H1-Y HRZ00□-W1-Y HRZ010-W1S-Y	HRZ00□-L2-Y HRZ010-W2S-Y
Allowable circulating fluids	—	Aqueous solution of 60% ethylene glycol	Deionized water
DI level display range	MΩ•cm	0 to 20	
DI level set range	MΩ•cm	0 to 2.0 (Note)	
DI level reduction alarm set range	MΩ•cm	0 to 2.0	

Note) The DI filter is needed to control the DI level. (SMC Part No.: HRZ-DF001)

Please purchase additionally because the DI filter is not included in this option. Also, if necessary, additionally purchase the insulating material for the DI filter. (SMC Part No.: HRZ-DF002)

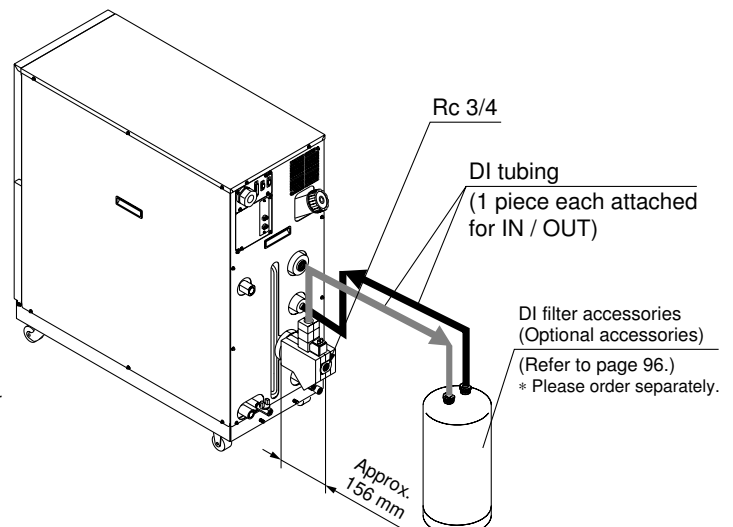

* Install the DI filter outside the thermo-chiller for piping. Secure the space for installing the DI filter on the rear side of the Thermo-chiller.
* It may go outside of the temperature stability range of $\pm 0.1^{\circ}\text{C}$ when this option is used in some operating conditions.

Z Option symbol
Circulating Fluid Automatic Recovery

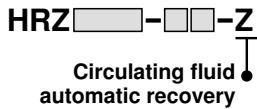

Select this option for customers who want to use the circulating fluid automatic recovery function. The automatic recovery function is a device which can recover the circulating fluid inside pipings into a sub-tank of the Thermo-chiller by the external communication or operating display panel. Some components need to be fitted by customer. For details, please consult "Product Specifications" information for these options.

Applicable model		HRZ001-H-Z HRZ001-H1-Z HRZ002-H-Z HRZ002-H1-Z	HRZ001-L-Z HRZ002-L-Z HRZ004-L-Z HRZ004-H-Z HRZ008-H-Z HRZ001-L2-Z HRZ004-L2-Z HRZ002-W-Z HRZ008-W-Z HRZ010-WS-Z HRZ010-W2S-Z	HRZ001-L1-Z HRZ002-L1-Z HRZ004-L1-Z HRZ004-H1-Z HRZ008-H1-Z HRZ002-L2-Z HRZ008-L2-Z HRZ002-W1-Z HRZ008-W1-Z HRZ010-W1S-Z	HRZ008-L-Z HRZ008-L1-Z
Circulating fluid recoverable volume ^{Note 1)}	L	15	16	17	
Purge gas	—	Nitrogen gas			
Purge gas supply port	—	Self-align fitting for O.D. ø8 ^{Note 2)}			
Purge gas supply pressure	MPa	0.4 to 0.7			
Purge gas filtration	µm	0.01 or less			
Regulator set pressure	MPa	0.15 to 0.3 ^{Note 3)}			
Recoverable circulating fluid temperature	°C	10 to 30			
Recovery start/stop	—	Start: External communication ^{Note 4)} or operation display panel / Stop: Automatic			
Timeout error	sec	Timer from recovery start to completion Stops recovering when the timer turns to set time. Possible set range: 60 to 300, at the time of shipping from the factory: 300			
Height difference with the customer system side	m	10 or less			

Note 1) This is the space volume of the sub-tank when the liquid level of the circulating fluid is within the specification. Guideline of the recovery volume is 80 % of the circulating fluid recoverable volume.
 Note 2) Before piping, clean inside the pipings with air blow, etc. Use the piping with no dust generation by purge gas. When using resin tubing, where necessary, use insert fittings, etc. in order not to deform the tubings when connecting to self-align fittings.
 Note 3) At the time of shipping from factory, it is set to 0.2 MPa.
 Note 4) For details, please consult our "Communication Specifications" information.

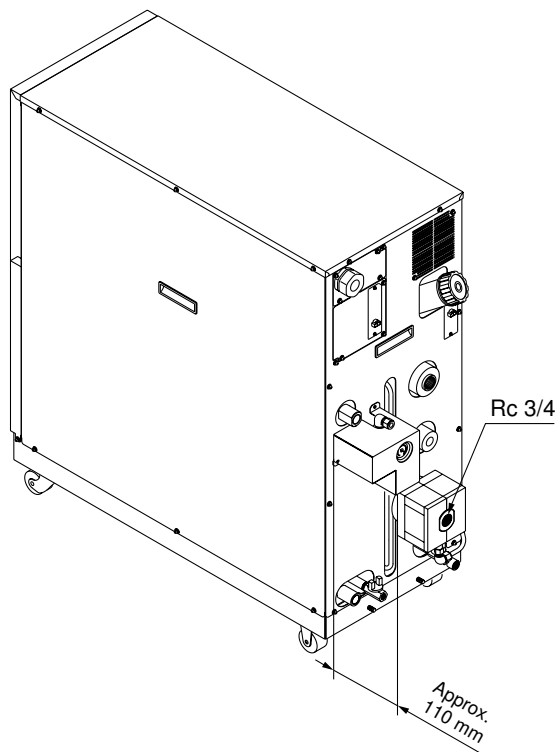

HRG
 HRGC
 HRZ
 HRW
 HEC
 HEB
 HED
 Technical Data
 Related Products



Series HRZ Specific Product Precautions 1

Be sure to read this before handling. Refer to back pages 1 and 2 for Safety Instructions and back pages 3 to 6 for Temperature Control Equipment Precautions.

Design

Warning

- This catalog shows the specification of a single unit.**
 - For details, please consult our "Product Specifications" and thoroughly consider the adaptability between the customer's system and this unit.
 - Although the protection circuit as a single unit is installed, the customer is requested to carry out the safety design for the whole system.

Selection

Caution

- Model selection**
In order to select the correct Thermo-chiller model, the amount of thermal generation from the customer's system, the operating circulating fluid, and its circulating flow are required. Select a model, by referring to the guideline to model selection of this catalog.
- Option selection**
Options have to be selected when ordering the Thermo-chiller. It is not possible to add them after purchasing the unit.

Handling

Warning

- Thoroughly read the operating manual.**
Read the operating manual completely before operation, and keep a copy on-site, for future reference.

Operating Environment / Storage Environment

Caution

- Do not use in the following environment because it will lead to a breakdown.**
 - Environment like written in "Temperature Control Equipment Precautions."
 - Locations where spatter will adhere to when welding.
 - Locations where it is likely that the leakage of flammable gas may occur.
 - Locations where the ambient temperature exceeds the limits as mentioned below.
 - During operation 10°C to 35°C
 - During storage 0°C to 50°C (but as long as water or circulating fluid are not left inside the pipings)
 - Locations where the ambient relative humidity exceeds the limit as mentioned below.
 - During operation 30% to 70%
 - During storage 15% to 85%
 - (Inside the operation facilities) locations where there is not sufficient space for maintenance.
 - In locations where the ambient pressure exceeds the atmospheric pressure.
- The Thermo-chiller does not have clean room specification. It generates dust from the pump inside the unit and the cooling fan in the refrigerator.**

Circulating Fluid

Caution

- Avoid oil or other foreign objects entering the circulating fluid.**

Circulating Fluid

- Use ethylene glycol which does not contain additives such as antiseptics.
- The condensation of the aqueous solution of ethylene glycol should be 60% or less. If the density is too high, the pump will be overloaded, resulting in occurrence of "Pump Breaker Trip FLT". Also, if the density is too low, the unit will freeze at lower temperatures, resulting in product failure.
- Avoid water moisture entering the fluorinated fluid. Otherwise, the unit will freeze, resulting in product failure.
- Use clear water (including for diluting ethylene glycol aqueous solution) which must meet the water quality standards as mentioned below.

Circulating Water (Clear Water) Quality Standards

The Japan Refrigeration and Air Conditioning Industry Association
JRA GL-02-1994 "Cooling water system – Circulating type – Supply water"

	Item	Unit	Standard value
Standard item	pH (at 25°C)	—	6.0 to 8.0
	Electrical conductivity (25°C)	[μS/cm]	100*1 to 300*2
	Chloride ion	[mg/L]	50 or less
	Sulfuric acid ion	[mg/L]	50 or less
	Acid consumption amount (at pH4.8)	[mg/L]	50 or less
	Total hardness	[mg/L]	70 or less
	Calcium hardness	[mg/L]	50 or less
Reference item	Ionic state silica	[mg/L]	30 or less
	Iron	[mg/L]	0.3 or less
	Copper	[mg/L]	0.1 or less
	Sulfide ion	[mg/L]	Should not be detected.
	Ammonium ion	[mg/L]	0.1 or less
	Residual chlorine	[mg/L]	0.3 or less
	Free carbon	[mg/L]	4.0 or less

*1 Electrical conductivity ratio should be 100 [μS/cm] or more.

*2 In the case of [MΩ·cm], it will be 0.003 to 0.01.

Transportation / Transfer / Movement

Warning

1. Transportation by forklift

- It is not possible to hang this product.
- The fork insertion position is either on the left side face or right side face of the unit. Be careful not to bump the fork against a roller or adjuster foot and be sure to put through the fork to the opposite side.
- Be careful not to bump the fork to the cover panel or piping ports.

2. Transportation by roller

- This product is heavy. Be sure to move the unit using more than 2 persons.
- Do not grab the pipings on the rear side or the handles of the panel.

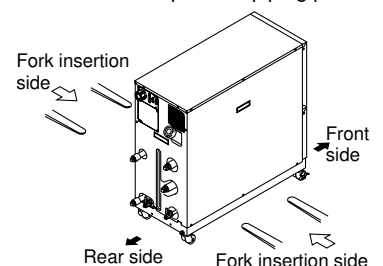



Series HRZ Specific Product Precautions 2

Be sure to read this before handling. Refer to back pages 1 and 2 for Safety Instructions and back pages 3 to 6 for Temperature Control Equipment Precautions.

Mounting / Installation

⚠ Caution

1. Avoid using this product outdoors.
2. Install on a rigid floor which can withstand this product's mass.
3. Install a suitable anchor bolt for the anti-quake bracket taking into consideration the customer's floor material.
4. Avoid placing heavy objects on this product.

Piping

⚠ Caution

1. Regarding the circulating fluid pipings, consider carefully the suitability for shutoff pressure, temperature and circulating fluid.

If the operating performance specifications are regularly exceeded, the pipings may burst during operation.

2. The surface of the circulating fluid pipings should be covered with the insulating materials which can effectively confine the heat.

Absorbing the heat from the surface of pipings may reduce the cooling capacity performance and the heating capacity may be shortened due to heat radiation.

3. When using fluorinated liquid as the circulating fluid, do not use pipe tape.

Liquid leakage may occur around the pipe tape. For sealant, we recommend that you use the following sealant: SMC Part No., HRZ-S0003 (Silicon sealant)

4. For the circulating fluid pipings, use clean pipings which have no dust, oil or water moisture inside the pipings, and blow with air prior to undertaking any piping works.

If any dust, oil or water moisture enters the circulating fluid circuit, inferior cooling performance or equipment failure due to frozen water may occur, resulting in bubbles in the circulating fluid inside the tank.

5. The reciprocating total volume of the circulating fluid pipings must be less than the volume of the sub-tank.

Otherwise, when the equipment is stopped, the in-built alarm may activate or the circulating fluid may leak from the tank. Refer to the specifications table for the sub-tank volume.

6. Select the circulating fluid pipings which can exceed the required rated flow.

For the rated flow, refer to the pump capacity table.

7. For the circulating fluid piping connection, install a drain pan just in case the circulating fluid may leak.

8. Do not return the circulating fluid to the unit by installing a pump in the customer system.

Electrical Wiring

⚠ Caution

1. Power supply and signal cable should be prepared by customer.

2. Provide a stable power supply which is not affected by surge or distortion.

If the voltage increase ratio (dV/dt) at the zero cross should exceed $40 \text{ V}/200 \mu\text{sec.}$, it may result in malfunction.

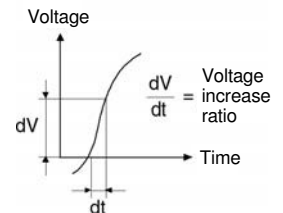

3. This product is installed with a breaker with the following operating characteristics.

For the customer's equipment (inlet side), use a breaker whose operating time is equal to or longer than the breaker of this product. If a breaker with shorter operating time is connected, the customer's equipment could be cut off due to the inrush current of the motor of this product.

Breaker operating characteristics

Applicable model

HRZ001-L	HRZ001-H
HRZ002-L	HRZ002-H
HRZ004-L	HRZ004-H
HRZ001-L1	HRZ008-H
HRZ002-L1	HRZ001-H1
HRZ004-L1	HRZ002-H1
HRZ001-L2	HRZ004-H1
HRZ002-L2	HRZ008-H1
HRZ004-L2	HRZ002-W
HRZ008-L2	HRZ008-W
	HRZ002-W1
	HRZ008-W1

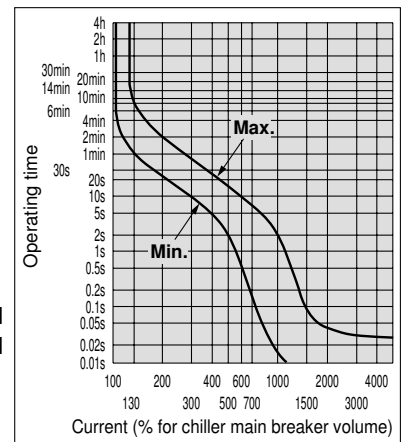

HRZ008-L
HRZ008-L1
HRZ010-WS
HRZ010-W1S
HRZ010-W2S

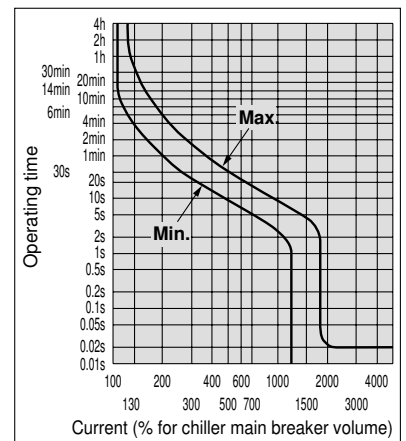

HRG

HRGC

HRZ

HRW

HEC

HEB

HED

Technical Data

Related Products



Series HRZ

Specific Product Precautions 3

Be sure to read this before handling. Refer to back pages 1 and 2 for Safety Instructions and back pages 3 to 6 for Temperature Control Equipment Precautions.

Operation

Caution

1. Confirmation before operation

1. The circulating fluid should be within the specified range of "HIGH" and "LOW".
2. Be sure to tighten the cap for the circulating fluid port until the click sound is heard.

2. Emergency stop method

In the case of an emergency, press down the EMO switch which is fitted on the front face of this product.

Operation Restart Time

Caution

1. Wait five minutes or more before restarting operation after it has been stopped. If the operation is restarted within five minutes, the protection circuit may activate and the operation may not start properly.

Maintenance

Warning

1. Do not operate the switch with wet hands or touch electrical parts such as an electrical plug. This will lead to an electrical shock.
2. Do not splash water directly on this product for cleaning. This will lead to an electrical shock or a fire.
3. When the panel was removed for the purpose of inspection or cleaning, mount the panel after works were done.

If the panel is still open, or running the equipment with the panel removed, it may cause an injury or electric shock.

Caution

1. In order to prevent a sudden product failure of the unit, replace the replacement parts every 36 months.
2. Perform an inspection of the circulating fluid every 3 months.
 1. In the case of fluorinated fluids:
Discharge the circulating liquid and avoid any dirty objects, or water moisture, or foreign objects entering the system.
 2. In the case of ethylene glycol aqueous solution:
Condensation must be 60%.
 3. In the case of clear water, deionized water:
Replacement is recommended.
3. Check the water quality of cooling water every 3 months.

Regarding the water quality standards for cooling water, refer to "Temperature Control Equipment Precautions".

Technical Data CONTENTS

A	Accumulator	P. 193	M	Magnet pump	P. 195
	Adjustment sensitivity (Hysteresis)	P. 197		Mechanical seal pump	P. 194
	Air-cooled condenser	P. 192	N	Non-return valve	P. 195
	Analog communication	P. 199		NRTL (National Recognized Test Laboratories)	P. 199
	ARW width (Anti-Reset Windup width)	P. 197	O	Offset function	P. 197
	Auto-tuning	P. 197		ON/OFF temperature control	P. 197
B	Band width, Temperature upper/lower limit width	P. 197		Overload relay	P. 198
	Breaker	P. 198	P	Particle filter	P. 195
C	Capillary tube	P. 192		Peltier element	P. 193
	Cascade pump	P. 194		Phase reversal relay (Plugging relay)	P. 198
	CE marking	P. 199		PID control	P. 197
	Centrifugal pump	P. 194		Pipe resistance	P. 194
	CFC refrigerant	P. 192		Power supply frequency	P. 198
	Check valve	P. 195		Propylene glycol aqueous solution	P. 196
	Circulating fluid/Constant temperature circulating fluid	P. 196		Protective devices in refrigeration circuits	P. 193
	Clear water	P. 196		PT sensor/Platinum resistance temperature detector	P. 196
	Compressor	P. 192		Pump capacity/Water-supply capacity	P. 193
	Condenser	P. 192		Pump heat input	P. 195
	Cooler	P. 192	PV		P. 196
	Cooling capacity	P. 195		PWM control	P. 197
	Cooling tower	P. 193	R	Refrigerant dryer	P. 192
	CSA standards	P. 199		Refrigerator	P. 192
D	DC canned pump	P. 195		Relay	P. 198
	DC power supply	P. 198		Relief valve	P. 195
	Degree of viscosity	P. 195		RS232C	P. 198
	Deionized water	P. 196		RS485	P. 198
	Density/Specific gravity	P. 195		RTD (Resistance Temperature Detector)	P. 196
	DeviceNet	P. 199	S	Sealing mechanism	P. 194
	DI filter	P. 195		SEMI F47	P. 199
E	Electrical conductivity	P. 196		SEMI S2	P. 199
	Electromagnetic contactor	P. 198		SEMI S8	P. 199
	Electromagnetic switch	P. 198		Signal input/output, I/O	P. 199
	EMO circuit	P. 198		Solenoid valve	P. 195
	Ethylene glycol aqueous solution	P. 196		Solid state relay (SSR)	P. 198
	eti mark	P. 199		Specific heat/Specific heat capacity	P. 195
	ETL mark	P. 199		Specific resistance	P. 195
	Evaporator	P. 192		Specified CFC	P. 192
	Expansion valve	P. 192		SV	P. 196
	External sensor	P. 197	T	Temperature fuse	P. 196
F	Facility water	P. 193		Thermal relay	P. 198
	Flow sensor/Flow switch	P. 195		Thermistor	P. 196
	Fluorinated fluids	P. 196		Thermo couple	P. 196
	Fluorinert™	P. 196		Thermoelectric device	P. 193
	Fundamentals of refrigeration circuits	P. 192		Thermoelectric system	P. 193
G	GALDEN®	P. 196		Thermo-module	P. 193
	Gear pump	P. 194		Thermostat	P. 196
H	Hardware interlock	P. 198		Three-phase power supply	P. 198
	Heat	P. 195		Time division proportional output	P. 197
	Heat load	P. 195		Turbine pump	P. 194
	Hot gas by-pass	P. 193	U	UL standards	P. 199
I	Impedance protection	P. 198	V	Vane pump	P. 194
	Insulation resistance	P. 199		Vortex pump	P. 194
	Insulation withstand voltage	P. 199	W	Water control valve	P. 193
	Inverter control	P. 193		Water-cooled condenser	P. 192
L	Learning control	P. 197			
	Level switch	P. 195			
	Lifting height/Pressure	P. 193			

HRG
HRGC
HRZ
HRW
HEC
HEB
HED
Technical Data
Related Products

Refrigeration Circuits, Peltier Elements, Cooling Sources

● Compressor

A compressor draws in low-pressure chlorofluorocarbon (CFC) refrigerant gas, compresses the gas and then discharges it as a high-pressure, high-temperature gas. Compressors are classified into various types (reciprocating, rotary, screw, etc.) according to the mechanical compression method used.

● Refrigerator

A compressor that compresses a refrigerant gas. These are called refrigerators to distinguish them from machines such as air compressors.

● CFC refrigerant

CFC (chlorofluorocarbon) refrigerants are organic compounds made up of elements including carbon, hydrogen, chlorine and fluorine. They are referred to generically using the DuPont brand name of Freon®.

When CFCs are used as heat-transfer mediums and circulated inside refrigeration circuits, causing heating and cooling during their condensation and evaporation phase changes, the CFCs are referred to as CFC refrigerants.

● Specified CFC

Due to their stability as a chemical substance and their safety with respect to humans, CFCs came to be widely used as industrial materials, particularly refrigerants. However, it was later recognized that when CFCs (and HCFCs (hydrochlorofluorocarbons)) containing chlorine are released into the atmosphere, they rise up into the ozone layer and deplete it. This resulted in the establishment of the Montreal Protocol in 1987, which classified CFCs such as Freon R12 and HCFCs such as Freon R22 as "specified CFCs" and prohibited their manufacture. As a result, their use has now almost completely died out.

Instead of specified CFCs and HCFCs, SMC products now use HFC refrigerants such as R134a and R404A that have an ozone depletion potential (ODP) of zero.

● Fundamentals of refrigeration circuits

In a refrigeration circuit, refrigerant gas injected into the circuit repeatedly travels through a cycle of compression, condensation, expansion and evaporation, creating high-temperature and low-temperature sections in the circuit. The compressor compresses low-pressure refrigerant gas and discharges the gas at a high temperature and pressure level. The hot, pressurized refrigerant gas enters the condenser where it is cooled by the external air or cooling water and condenses to form a high-pressure liquid refrigerant. As the high-pressure liquid refrigerant passes through a constricting mechanism, such as an expansion valve, it rapidly depressurizes and some of the refrigerant evaporates. The release of evaporation heat causes the refrigerant itself to cool so that it becomes a combination of gas and liquid at a low-

temperature and pressure level. In its combined gas-liquid state, the refrigerant enters the evaporator where it continually evaporates while absorbing the heat within the evaporator, thereby cooling the interior of the evaporator. When the refrigerant emerges from the evaporator, it evaporates entirely and becomes a low-pressure refrigerant gas. The low-pressure refrigerant gas is then drawn into the compressor and again becomes a high-temperature, high-pressure gas as the cycle is repeated.

● Condenser

A heat exchanger used to condense high-temperature, high-pressure refrigerant gas. A condenser has the function of releasing heat drawn up by the refrigeration circuit to the outside. Condensers can be air-cooled or water-cooled, depending on the cooling method used.

● Air-cooled condenser

Air-cooled condensers are generally made up of copper tubes through which the refrigerant flows, with numerous thin aluminum fins attached around the outside of the tubes. Outside air is forced over the fins by a device, such as a fan motor, to cool the pipes to the ambient temperature and condense the refrigerant gas.

If an air-cooled condenser is installed inside a building, it can be used to heat the interior of the building since the heat generated by the refrigeration circuit is released as waste heat from the outside of the condenser. The room in which an air-cooled condenser is installed must have adequate ventilation or air-conditioning equipment.

● Water-cooled condenser

A heat exchanger that uses cooling water to cool and condense the coolant. Water-cooled condensers can be used in environments, such as large factories where cooling tower water or the cooling water for an air-conditioning system can be circulated and used.

Depending on their construction, heat exchangers can be double-pipe type, shell-and-tube type or plate type units.

● Refrigerant dryer

In a refrigeration circuit, a refrigerant dryer consists of filters that absorb and remove moisture inside the refrigeration circuit. Refrigerant dryers are normally installed in pipes carrying liquid refrigerant after it emerges from the condenser.

● Expansion valve

A component that creates an expansion in the refrigeration circuit. As the refrigerant passes through this valve, a large pressure loss results, thereby making it possible to create high-pressure and low-pressure segments within the refrigeration circuit.

There are several types of expansion valve, including constant-pressure expansion valves and thermal expansion valves. Such types allow the size of the valve aperture to be adjusted using refrigerant pressure or temperature feedback from an outlet passage.

● Capillary tube

The capillary tubes used in refrigeration circuits are simply small-caliber copper tubes, normally used in the expansion step, that act as a fixed restrictor in the refrigerant passage.

● Evaporator

A heat exchanger used to cool the target substance (e.g., water or air) using the evaporative heat from a low-temperature, low-pressure combined gaseous and liquid refrigerant in the refrigeration circuit.

● Cooler

→ Evaporator

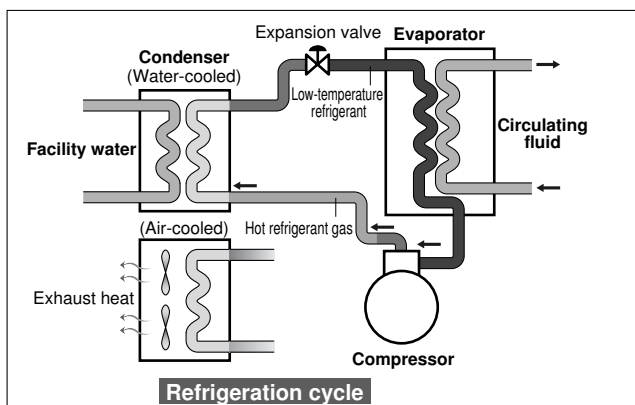

● Accumulator

A tank installed in a refrigeration circuit on the inlet side of the compressor. A compressor is a component designed to compress gas, so a malfunction will occur if any liquid coolant enters the compressor. Installing an accumulator has the function of separating out the coolant gas that is sucked into the compressor and any remaining refrigerant, and of preventing the liquid refrigerant from being sucked into the compressor. The inclusion of an accumulator creates a system that is highly resistant to variability in factors such as the cooling load.

● Hot gas by-pass

A refrigeration circuit sometimes includes a circuit that allows high-temperature, high-pressure refrigerant gas (hot gas) discharged from the compressor to by-pass the condenser so that it reaches the evaporator (on the low-pressure side) without being condensed. This prevents the evaporator temperature (on the low-pressure side) from dropping too far and reduces the risk of liquid refrigerant being drawn into the compressor when the cooling load is low (if there is nothing to refrigerate), thereby ensuring more stable functions of the refrigeration circuit.

This also allows a flow of hot gas to be intentionally directed to the evaporator with the aim of heating the evaporator rather than cooling it.

● Water control valve

A water control valve, installed on the cooling water pipe for a water-cooled condenser, used to adjust the amount of cooling water flowing to the condenser. Water control valves can be either pressure-regulated or temperature-regulated, with the amount of flow regulated using feedback from the condensing pressure or condensing temperature, respectively.

When the cooling water temperature is low, a large flow of cooling water to a water-cooled condenser reduces the condensing pressure and lowers the cooling capacity. In this sort of situation, a water control valve restricts the cooling water flow and maintains the condensing pressure at the desired value. Water control valves also have the function of reducing water consumption by preventing unnecessarily large flows of cooling water.

● Inverter control

In compressors that use an ordinary AC motor, the motor rotation rate is fixed according to the frequency of the AC power supply, with the result that the refrigerant discharge rate is also fixed. Inverter control in a refrigeration circuit is the use of an inverter to vary the compressor rotation rate and thereby control the rate of refrigerant circulation.

This provides means of saving energy by, for example, running the compressor at a slower rate when the cooling load is low.

● Protective devices in refrigeration circuits

In refrigeration circuits, protection must be provided for electrical components such as compressors, and against abnormal refrigerant pressures. Protective measures for compressors (motors) include protective devices such as overload relays (built into the compressor to detect overcurrent and overheating), thermal relays (fitted externally to detect motor overcurrent) and temperature switches.

The devices used to protect against pressure faults include pressure switches, safety valves and rupture disks. However, in refrigeration circuits built into compact devices, the protective devices are often confined to just overload relays, or just thermal relays and pressure switches depending on the anticipated level of risk.

● Facility water

The cooling water flowing through a water-cooled condenser used to expel waste heat generated in the refrigeration circuit

to the outside.

In ordinary factories or buildings, fluids such as cooling tower water or chiller water are used as facility water.

● Cooling tower

A cooling tower is a facility that uses cooling water to expel the waste heat circulated and collected inside a factory or other building into the outside air. Cooling towers are installed in outdoor locations such as on the rooftops of buildings. The cooling water is sprayed down like a shower from the top of the cooling tower and forcibly brought into contact with the outside air by a fan motor. As well as being directly cooled by the temperature of the outside air, the partial evaporation of the cooling water itself draws off evaporation heat, cooling the water further.

Because cooling towers are directly cooled by the outside air, the resulting cooling water temperature varies seasonally depending on the climatic conditions. In addition, the cooling water cannot theoretically be cooled to a temperature any lower than 5°C above the wet-bulb temperature of the outside air.

● Peltier element

An element with a structure made up of alternating layers of flat P-type and N-type semiconductors arrayed in series. When a direct current flows through the element, heat moves from one plate surface to the next, so that one surface is cooled as the opposing surface is heated. This is referred to as the Peltier effect.

By changing the direction of current flow, the direction of heat movement can also be changed, providing a simple means of cooling and heating.

● Thermo-module

→ Peltier element

● Thermoelectric device

→ Peltier element

● Thermoelectric system

A temperature control system that uses a Peltier element to directly cool and heat a liquid, gas or solid.

Heat exchangers suitable for fluids are installed on both sides of the Peltier element, with the fluid to be temperature-controlled on one side of the element while the heat exchanger on the other side is used to dissipate heat.

Fluid Control and Heat-related

● Pump capacity/Water-supply capacity

A pump's water-supply capacity is indicated by the amount of water it can cause to flow at a given pressure (lifting height).

The characteristic curve (pump curve) that indicates the correlation between pressure and flow rate varies depending on the pump type, and thus, the user must check that the type of pump selected is suitable for the intended application.

● Lifting height/Pressure

Lifting height (in meters) is often used instead of pressure to indicate the pump capacity. Lifting height is a numerical value that indicates the capacity of a pump in terms of the height (in meters) to which it can lift a fluid.

The value for pressure is obtained by multiplying the lifting height by the density of the fluid; for example, if a pump capable of generating a lifting height of 10 meters is used to pump water, which has a density of 1 kg/l, the unit pressure generated by the pump is 1 kgf/cm² (0.1 MPa).

If a more dense fluid is used, the pressure is higher even though the lifting height remains the same.

HRG

HRGC

HRZ

HRW

HEC

HEB

HED

Technical
Data

Related
Products

- **Pipe resistance**

When water or another fluid is caused to flow through a passage composed of pipes, valves, etc., the pressure differential generated by friction between the various devices and the fluid is known as "pipe resistance." A synonymous term is "pressure loss."

- **Centrifugal pump**

This is one type of pump in which a bladed wheel (impeller) spins inside the pump chamber (casing), applying centrifugal force to the fluid. This force is converted to pressure that discharges the fluid. A large volume of fluid can be pumped, but it is difficult to attain high pressure. When high-pressure is desired, a type fitted with multistage impellers can be used. This is a low-lifting height, high-flow volume pump.

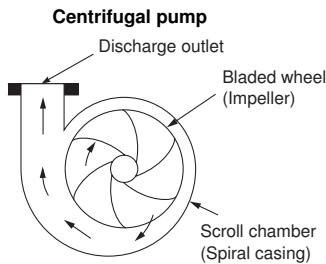

- **Vortex pump**

In this type of pump, a bladed wheel (impeller) spins inside the pump chamber (casing), applying centrifugal force to the fluid. This force is converted to pressure that discharges the fluid. As in a centrifugal pump, the fluid is discharged using centrifugal force, but the impeller has more blades than in a centrifugal pump, and in the pump chamber (casing), the aperture (clearance) is set more narrowly, allowing for a higher discharge pressure. The pressure and flow characteristics attained are somewhere between that of a centrifugal pump and a vane pump. This is a mid-lifting height, mid-flow volume pump.

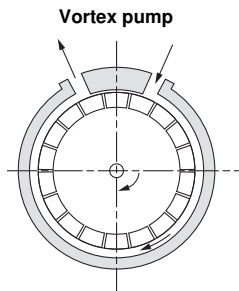

- **Turbine pump**

→ Vortex pump

- **Cascade pump**

→ Turbine pump

- **Vane pump**

In this type of pump, vanes set in a rotor inside the pump chamber brush against the inside walls of the chamber as they rotate, pushing out and discharging the fluid that is surrounded by the vanes, rotor and pump chamber walls. This is a type of PD (positive displacement) pump.

This is a high-lifting height, low-flow volume pump.

The vanes slide against the interior walls of the pump chamber, generating abrasion powder. In addition, this type of pump is susceptible to entry of foreign objects such as outside debris, etc.

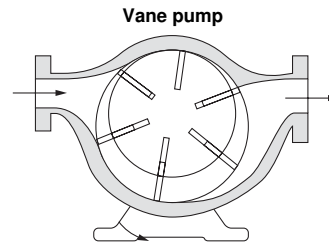

- **Gear pump**

Like the vane pump, this is a type of PD (positive displacement) pump, in which a pair of gears meshes with one another and rotates, pushing the fluid through the gap between them and discharging it.

This is a high-lifting height, low-flow volume pump.

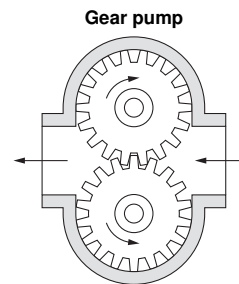

- **Sealing mechanism**

The bladed wheel (impeller) in the pump chamber through which the fluid passes is linked to the shaft of the external electric motor, and the rotation of the impeller discharges the fluid. As water or other fluids seeping through the motor shaft and reaching the electric motor can cause short circuits and other damage, it is necessary to have a mechanism sealing the pump chamber off from the shaft. This is known as a "sealing mechanism."

There are mechanical seal types, magnet coupling types and others.

- **Mechanical seal pump**

This is a general terms for pumps that use mechanical seals for the sealing mechanism.

The rotating seal mounted on the motor shaft side and the fixed seal mounted on the pump chamber side rotate, and their surfaces touch one another, sealing off the fluid. As a result, there is a slight, external leakage of fluid. The volume of leakage increases over time, so it is necessary to replace the seal portions regularly.

This type can be used for applications where the motor shaft and impeller are directly linked and there is high-shaft power.

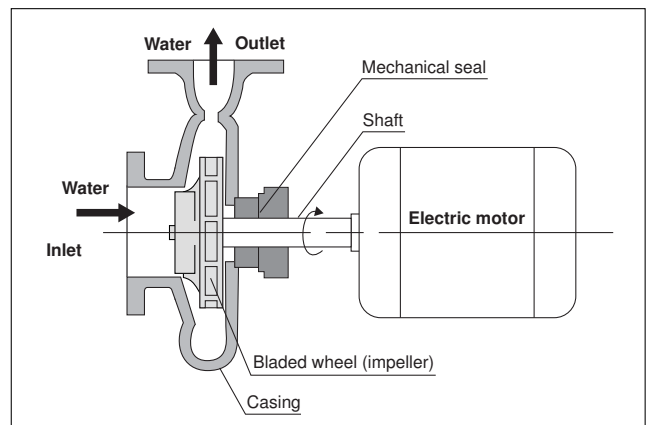

- **Magnet pump**

This is a general term for pumps that use magnetic coupling for the sealing mechanism.

Using magnetism to couple the rotor on the inside of the pump chamber to the permanent magnet mounted on the motor shaft side, with the pump chamber wall between them, the rotation is conveyed to the rotor inside the pump chamber. Since the pump chamber can be completely separated, pump chamber can be completely sealed off, so there is absolutely no external leakage.

Since a large magnet coupling is needed, this type of pump is more difficult to make in small sizes than the mechanical seal type, and the cost is also higher.

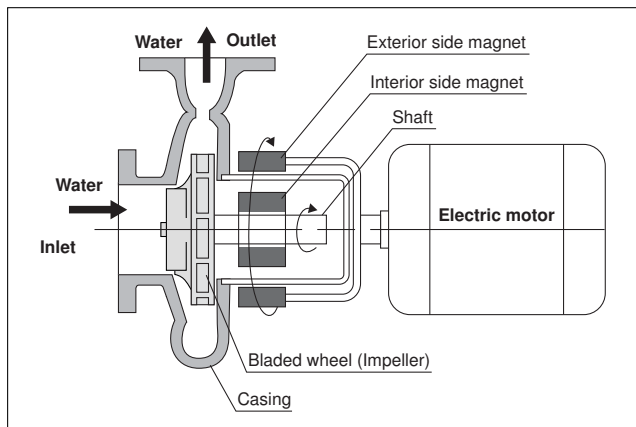

- **DC canned pump**

A pump with a seal-less construction combining the motor and the pump in one. It can be made in compact sizes with absolutely no external leakage of fluid. A DC brushless motor is used.

- **Pump heat input**

The volume of heat applied to the circulation loop, generated by the operation of the pump. When calculating the overall volume of heat applied to the circulation loop, it is necessary to consider the volume of heat generated by the pump, along with that of the object being cooled.

The pump converts the electrical power entering the motor into the kinetic energy of the fluid, which causes the fluid to circulate. This kinetic energy is reduced as a result of undergoing pressure loss inside the piping, and eventually the entirety of the kinetic energy is released into the circulating fluid as heat.

While there are differences depending on the type of pump, for rough calculations, the nominal heat emitted from the pump can be treated as the pump heat input.

- **Solenoid valve**

A component that switches the flow of fluid from ON to OFF, or changes the direction by moving the plunger (iron core) using the force of electromagnetism.

- **Relief valve**

When the inlet pressure exceeds a set level, this valve opens to release the outlet pressure.

- **Flow sensor/Flow switch**

These components monitor the flow rate of the fluid. The flow sensor measures the flow rate linearly. The flow switch only has the function of commencing operation when the flow rate reaches a certain level, and does not perform measurement of the flow volume.

- **Particle filter**

A filter that removes debris and other particles.

- **Check valve**

A check valve is a device that prevents reverse flow of the fluid, keeping it flowing in one direction only.

- **Non-return valve**

→ Check valve

- **Level switch**

A switch that detects the fluid level inside the liquid tank. There are many different types, but the most common type employs a floating buoy, which causes a lead switch (magnetic switch) to turn ON and OFF.

- **DI filter**

A filter that is filled with ion exchange resin used to remove leftover ions from the water. DI stands for "deionized," while "DI water" is deionized water, or water with its ions removed.

Fluid Properties, Materials, Physical Values

- **Density, specific gravity**

The mass per unit of volume, measured in units of [kg/m³]. Specific gravity is the ratio of the density of a given substance to the density of water, and is a dimensionless quantity. When expressing this quantity within the CGS system of units, density and specific gravity have the same value.

- **Degree of viscosity**

Thickness of a fluid. The units used to express absolute degree of viscosity are [Pa·s] units, but it is often expressed within the CGS system of units with [P] (Poise).

$$1 [\text{Pa}\cdot\text{s}] = 10 [\text{P}]$$

The value obtained by dividing absolute degree of viscosity by density is called the kinetic viscosity. This can be measured in [m²/s] units, but in general, [St] (Stokes) are used.

$$1 [\text{St}] = 0.0001 [\text{m}^2/\text{s}]$$

- **Specific heat, specific heat capacity**

The heat energy required to increase the temperature of an object by a certain temperature interval, under specific pressure and volume conditions.

$$\text{The specific heat of water: } 1 [\text{cal}/\text{g}\cdot\text{K}] = 4.184 \times 10^3 [\text{J}/\text{kg}\cdot\text{K}]$$

- **Cooling capacity**

The volume of heat (heat energy) that temperature control equipment can absorb (cool) per unit of time, at an arbitrary temperature.

- **Heat load**

→ Cooling capacity

- **Heat**

Terms such as heat, heat load, cooling capacity, etc., that are used in this catalog, indicate quantities of heat that can be absorbed or radiated per unit of time. As a result, the units employed are [W] = [J/s] (work rate) or [kcal/hr].

$$1 \text{ kW} = 860 \text{ kcal/hr}$$

- **Specific resistance**

A value indicating the electrical insulating properties of a liquid, and the unit used is [Ω·cm]. When expressing the specific resistance of deionized water, it is sometimes called "DI level." At 25°C, the specific resistance of theoretically 100% deionized water is 18.3 [MΩ·cm].

HRG
 HRGC
 HRZ
 HRW
 HEC
 HEB
 HED
 Technical Data
 Related Products

● Electrical conductivity

A value indicating the ease with which electricity passes through a liquid, and is inversely proportional to the specific resistance. The unit used is [S/m], incorporating [S] (Siemens), the opposite of [Ω] (resistance).

At 25°C, the electrical conductivity of theoretically 100% deionized water is 0.055 [$\mu\text{S}/\text{m}$].

● Clear water

Water that has been filtered and distilled and any impurities eliminated. It is also known as purified water.

● Deionized water

Water that has had any impurities or ion elements removed. It is obtained by removing ion elements with ion exchange resin, after filtering out impurities with a particle filter. Its theoretical specific resistance has a limit of 18.3 [$\text{M}\Omega\cdot\text{cm}$], but it is impossible to actually attain this value. As a general rule, water with a specific resistance of 1 to 10 $\text{M}\Omega\cdot\text{cm}$ is referred to as deionized water.

● Ethylene glycol aqueous solution

Ethylene glycol is a type of alcohol, and adding it to water causes the freezing point of the water to drop. It is a major ingredient in antifreeze for automobiles. At a concentration of 60%, the freezing point drops to -40°C or lower, but the viscosity increases as the temperature drops, so taking fluidity into account, it is practical to consider about -20°C as the minimum temperature.

By adding ethylene glycol to deionized water, it is possible to raise the fluid's specific resistance, so it can be used for applications where circulating fluid with high insulating properties is desired.

● Propylene glycol aqueous solution

Propylene glycol is a type of alcohol, and adding it to water causes the freezing point of water to drop. Like ethylene glycol, it is a major ingredient in antifreeze for automobiles. It has lubricating properties, and is characteristically non-volatile.

● Fluorinated fluids

Inert fluids in the fluorine series. There are many types, including perfluoropolyether (PFPE), perfluorocarbon (PFC), hydrofluoropolyether (HFPE), and hydrofluoroether (HFE), but they share the characteristic of high electrical insulation properties, and grades can be selected with appropriate fluidity even at low temperatures, such as -100°C , and high temperatures, such as 200°C and above.

They are chemically inert and non-poisonous.

Products are sold on the market, such as Fluorinert, made by 3M, and GALDEN, made by Solvay Solexis.

● GALDEN®

The product name of a fluorinated fluid manufactured by Solvay Solexis. It is a perfluoropolyether with a high polymer compound, and various grades can be selected with differing temperature ranges and viscosity ranges depending on the degree of polymerization.

● Fluorinert™

The product name of a fluorinated fluid manufactured by 3M. Its basic structure is a perfluorocarbon, but it has a wide variety of chemical structures, and various grades can be selected with differing temperature and viscosity ranges.

● Circulating fluid, constant temperature circulating fluid

Fluid that circulates among the customer's equipment, with temperature controlled by a chiller.

Taking freezing temperature, boiling point, electrical insulation properties and so on into consideration, clear water, deionized water, ethylene glycol aqueous solution, fluorinated fluids, etc., can be selected depending on the application.

Temperature Measurement and Control

● PT sensor, platinum resistance temperature detector

A type of temperature sensor taking advantage of the properties of platinum (Pt), which has an electrical resistance that increases in proportion to the temperature. A sensor with the specification Pt 100 Ω has a resistance of 100 Ω at 0°C . As the resistance value is relatively small, and the sensor is easily influenced by the resistance value of the conductive wires, an input circuit is generally used which cancels out the resistance value of the conductive wires, by using, for instance, 3-wire or 4-wire wiring configurations and long conductive wires.

● RTD (Resistance Temperature Detector)

→ PT sensor

● Thermo couple

This is created by forming a loop, connecting the ends of two wires made of two different metals, and by keeping the two wires at separate temperatures at the connecting point. Thermoelectric power is generated according to this temperature differential (the Seebeck effect).

As a sensor, by keeping the end of one wire at a standard temperature and measuring the thermoelectric power generated, it can determine the temperature of the other wire terminal. A thermo couple is a sensor employing this principle.

● Thermistor

A temperature sensor employing a semiconductor with electrical resistance that changes in accordance with the temperature. There are two types,

PTC: positive temperature coefficient (a type for which the resistance increases as the temperature rises)

NTC: negative temperature coefficient (a type for which the resistance decreases as the temperature rises.)

The resistance value is generally large, amounting to several $\text{M}\Omega$, and there is little influence from the resistance of the conductive wires, so a 2-wire configuration is generally used.

● Thermostat

A switch that turns ON or OFF when it reaches a certain set temperature. Most thermostats are bimetallic.

They are sometimes used for direct temperature control, such as switching a heater ON or OFF, but are also used often for safety circuits which switch OFF when the temperature becomes abnormally high.

The switch can be returned to its original position either automatically or manually.

● Temperature fuse

A fuse in which an internal metal wire melts, breaking the circuit when exposed to a temperature exceeding the set temperature. When this kind of fuse blows, it cannot be reset and must be replaced.

● PV

PV: Process Value. In temperature control equipment, this indicates the current temperature measured by the temperature sensor.

● SV

SV: Set Value. In temperature control equipment, this indicates the target value (set value) for performing temperature control.

- **ON/OFF temperature control**

A control method for adjusting temperature by turning temperature control output ON or OFF relative to the set temperature. When the temperature is above (below) the set temperature, output of the refrigerator (heater) is turned ON, and when the temperature is below (above) the set temperature, output is turned OFF.

Since there are only two operating rates relative to the set temperature, 0% or 100%, this is also called 2-position control.

- **Adjustment sensitivity (Hysteresis)**

When the PV is extremely close to the SV in ON/OFF control, there may be "chattering" where the temperature control output repeatedly turns ON/OFF with small temperature variations, and this may have an adverse impact on output relays and connected equipment. To prevent this, spacing is provided between ON and OFF operation to stabilize control. This operation spacing is called adjustment sensitivity (hysteresis).

For example, if the cooling output ON point (SV) is set to 20.0°C and hysteresis is set to 1.0°C, then cooling output will go OFF when temperature drops to 19.0°C, and go ON when temperature rises to 20.0°C.

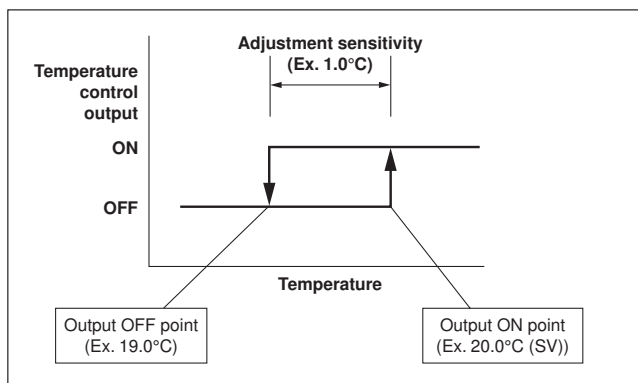

- **PID control**

A control method for producing temperature control output by comparing the temperature difference between the input value from the temperature sensor (PV) and the set temperature (SV), and using a combination of P (Proportional) operation, I (Integral) operation and D (Derivative) operation. Output is linearly variable from 0 to 100%, and this enables smooth temperature control with no temperature wavering.

P (Proportional) operation: Operation where the amount of output is varied from 0 to 100% in proportion to the deviation between PV and SV (temperature difference). The range of temperatures for performing proportional operation (proportional band) must be input as a parameter.

I (Integral) operation: Operation where the temperature discrepancy is corrected by adjusting the amount of output relative to the time that deviation between PV and SV has continued. Since the amount of output is determined in response to the time that deviation continues, the integral time must be input as a parameter.

D (Derivative) operation: Operation where output is produced in accordance with the derivative (speed of change) of the temperature deviation. This is used to quickly correct sudden temperature variations when there is a sudden change in the ambient environment or load. The derivative time is input as a

parameter, and the longer the derivative time, the stronger the correction output that is produced.

- **ARW width (Anti-Reset Windup width)**

Range of integral operation used for PID control. This value is used to designate the range for calculating the integral term, to suppress buildup of the integral component.

- **Auto-tuning**

In PID control, P, I, D and each parameter must be optimally set for the balance of the heat capacity of all parts where the circulation loop is connected. Auto-tuning refers to a function for automatically determining the setting of those parameters. SMC's temperature control equipment is shipped with PID parameters set at factory shipment to the greatest common factor for the various use conditions. However, if those parameter settings are likely to be unsuitable for the actual operating environment, some models provide a function which can automatically set parameters by using auto-tuning.

- **Time division proportional output**

When controlling output of a heater or other device via a relay or SSR, this method of operation makes the ratio of ON time to OFF time proportional to the control output over a fixed time (0.2 to 1.0 sec) in accordance with a previously set time cycle.

For example, if the control cycle is 1.0 sec, and the control output is 70%, then the ON time will be 0.7 sec and the OFF time 0.3 sec.

- **PWM control**

→ Time division control

- **Offset function**

Function for shifting the target temperature for actual temperature control from SV by adding or subtracting a separately set offset value (+ or - a certain number of °C) to or from the set temperature (SV).

For example, if the temperature upon arrival at the object of temperature control is shifted higher (or lower) relative to the temperature discharged from the chiller because a certain amount of heat input is received from piping due to the effects of ambient temperature, this offset value is set to correct that effect.

- **Learning control**

A function for automatically calculating and setting the offset value (correction value for the set temperature).

A temperature sensor (external sensor) is provided near the object to be temperature controlled, and those signals are input to the chiller. The offset value is automatically calculated from the deviation between the discharged temperature and the external sensor.

- **External sensor**

Temperature sensor mounted to the outside of temperature control equipment and used for learning control etc.

- **Band width, Temperature upper/lower limit width**

Temperature range for outputting alarms etc., when PV deviates by more than a fixed temperature from the set temperature (SV).

HRG

HRGC

HRZ

HRW

HEC

HEB

HED

Technical Data

Related Products

Power Supply, Electrical Equipment

● Power supply frequency

There are two frequencies for commercial AC power: 50 Hz and 60 Hz. The AC motors installed in temperature control equipment turn at a rotation speed corresponding to the power supply frequency. When operating with a 60 Hz power supply, the rotation speed is generally 10% faster than with 50 Hz. In the case of a pump, the flow rate and pressure increase, and in the case of a compressor in a refrigeration circuit, the cooling capacity increases. Current consumption also increases in the same way.

In the case of a resistance load, such as a DC pump or heater, performance does not depend on the frequency.

● Three-phase power supply

With three-line AC current or AC voltage, the phases of the lines are shifted by 120°.

The current values of each line are $1/\sqrt{3}$ smaller than single phase with the same level of transmitted power, so thinner wires can be used. There is also the advantage that a rotating magnetic field can be easily produced. (It is possible to use a 3-phase motor with a simple structure.)

A 3-phase power supply is used for equipment with high output.

● Breaker

A device which protects load circuits and wires by breaking the circuit when an abnormal current flows in an outlet circuit due to problems such as overload or shorting. Depending on the application, a breaker may be called a motor breaker, circuit protector or other names. Ground fault circuit interrupters monitor both current in the main circuit and leakage current, and break the circuit if leakage current is too high.

● Relay

A switch which turns a mechanical contact ON/OFF with the power of an electromagnet (solenoid). This makes it possible to turn ON/OFF the high power of the contact with the low power needed to drive the electromagnet only, and thus relays are used for amplification. They are also frequently used as logic elements in sequence circuits.

● Electromagnetic contactor

An electric device for turning power circuits ON/OFF to start and stop power equipment (e.g. motors, heaters). Just like a relay, these devices open or close a mechanical contact with the power of a solenoid. The principle of operation is the same as a relay, but a contactor is designed for high-voltage and large current.

● Thermal relay

A circuit protection device incorporated into the power input circuit of a motor to provide output when motor overcurrent is detected. It is comprised of a heater which heats up in response to current, and a bimetal which opens and closes a contact in response to that heat. Since the thermal relay itself cannot open and close a high capacity power circuit, the main circuit for a motor or other device is broken by incorporating a control circuit with an electromagnetic contactor or relay.

● Electromagnetic switch

A device integrating an electromagnetic contactor with a thermal relay.

● Overload relay

This has the same structure as a thermal relay, and is used for the same purpose. Overload relays built into the compressors of small refrigeration circuits are installed on the wall of the compressor, and are actuated not by heat due to overcurrent but by the temperature of the compressor itself. In many small

compressors, the main circuit is directly broken by the overload relay.

● Impedance protection

A type of motor protection generally used for small AC fan motors and other small motors.

The motor is constructed so that it will not rise above a certain temperature, even when locked for some reason, due to the inherent impedance (AC resistance) of the motor coil itself. Therefore, the motor itself is protected against burnout, even though no thermal relay or other protective device is installed.

● Solid state relay (SSR)

A relay which enables switching of high power using low power by using a thyristor or other semiconductor element. In comparison with an electromagnetic relay, this type has no mechanical moving parts, and thus is capable of high-speed switching. SSRs are compact, and have a long service life.

However, this does not mean that contacts are physically isolated. The fact that there is some leakage current even when the device is OFF must be taken into account.

● Phase reversal relay (Plugging relay)

A switch which monitors the phase sequence of a 3-phase main power supply, and issues a warning if anything is abnormal.

When driving a 3-phase motor with a 3-phase power supply, the motor will turn backwards if the phase sequence of wiring is wrong. This relay is installed to prevent such reverse rotation. These relays are also called plugging relays.

● DC power supply

A device which produces DC power from commercial AC power. DC power is for CPUs inside equipment and other control circuits. Peltier elements for Peltier circulators, thermoelectric baths and other equipment are driven with DC power, so they have a high-capacity DC power supply built-in.

● EMO circuit

An EMO (EMergency Off) circuit is an electrical circuit provided to shut off all power and ensure safe conditions when an emergency stop button (EMO button) is pressed in an emergency.

● Hardware interlock

This is an equipment control circuit for shutting off power in case of trouble. The circuit is logically configured using only relays and other hardware, and does not use software running on the CPU.

● RS232C

A standard for serial communication. This is the communication standard when connecting a PC with an acoustic coupler or modem, and is used for one-to-one communication between PCs.

Since RS232C itself only roughly stipulates the use of wiring systems and other hardware, detailed hardware specifications and software protocols are determined independently by each equipment manufacturer.

● RS485

A standard for serial communication. Only one-to-one communication between devices can be done with RS232C, but with RS485 it is possible to communicate simultaneously with multiple devices by wiring them in a chained, multidrop fashion, and providing addresses via software.

Since RS485 itself only roughly stipulates the use of wiring systems and other hardware, detailed hardware specifications and software protocols are determined independently by each equipment manufacturer. Actual detailed protocols are determined independently by each equipment manufacturer.

- **DeviceNet**

A standard for serial communication.
An open network owned by ODVA (Open DeviceNet Vendor Association Inc.), a non-profit organization headquartered in the US. This is a field network standard covering a wide scope, from the sensor level to the device level.

- **Analog communication**

A method of communicating with external devices using voltage output such as 0 to 10 V. This enables output of PV (measured temperature etc.) and reception of values like SV (set temperature).

- **Signal input/output, I/O**

Input/Output signals such as alarm signal, or operation signals. Since there are various communication methods depending on the equipment model, such as relay output and open collector output, communication specifications must be checked before wiring.

- **Insulation withstand voltage**

Electric potential difference where an insulator material will not be destroyed. In withstand voltage testing at product shipment from the factory, a high AC voltage of 1.5 kV (varies depending on the model) is applied between the electric circuit conductor and the chassis (grounded). Then it is checked that there is no flow of leakage current above the reference value.

- **Insulation resistance**

Electrical resistance between the conductor inside the device and the chassis (grounded). In insulation resistance testing at product shipment from the factory, it is checked that the resistance value with a measured DC voltage of 500 V (or 250 V) is at or above the reference value (a value such as 1 MΩ; varies depending on the model).

- **eti mark**

eti (Electro-Test Inc.) is an NRTL, and issues the eti mark. This mark demonstrates compliance with UL standards.

- **ETL mark**

Intertek ETL SEMKO is an NRTL, and issues the ETL mark. This mark demonstrates compliance with UL standards.

- **SEMI S2**

SEMI is an international industry association of companies producing equipment and materials for the manufacture of semiconductors and flat panel displays. It has established its own standards as safety guidelines for the design of semiconductor manufacturing equipment.

SEMI S2 requirements relate to the work environment, health and safety for products used in semiconductor manufacturing, and cover chemical, radiation, electrical, physical, mechanical, environmental, fire, earthquake, emissions and ergonomics, as well as quality, documentation and manuals etc. Many semiconductor manufacturers require that equipment operating in their plants comply with SEMI S2.

- **SEMI S8**

SEMI S8 is a guideline on ergonomics which is more detailed than the ergonomic requirements in Section 14 of SEMI S2.

- **SEMI F47**

SEMI F47 is a SEMI standard which stipulates guidelines regarding voltage sag immunity. Semiconductor manufacturers require this standard for temperature control equipment, just like SEMI S2.

Safety Standards

- **CE marking**

For machinery and other equipment distributed in the EU (European Union), it is mandatory to display the CE mark. To display the CE mark, a product must declare itself to be in compliance with EU Directives. The main EU Directives relating to the products in this catalog are the Machinery Directive, EMC Directive and Low Voltage Directive. Each directive requires product compliance with the corresponding EN Standard (European Standard).

- **UL standards**

Standards of a non-profit testing organization founded by the US National Fire Protection Association.
In the US, some states and municipalities require UL certification for the sale of electrical products.

- **CSA standards**

Safety standards by the Canadian Standard Association, a non-governmental Canadian standardization organization.
Electrical products distributed in Canada must be CSA certified.

- **NRTL (National Recognized Test Laboratories)**

Testing organizations capable of certification (of UL or CSA standards etc.) which have been recognized according to Occupational Safety and Health Law set forth by OSHA (the US Occupational Safety and Health Administration). At present, 18 organizations have been recognized as NRTLs. UL and CSA are examples of certified organizations.

HRG

HRGC

HRZ

HRW

HEC

HEB

HED

Technical Data

Related Products

Temperature Control Equipment Related Products

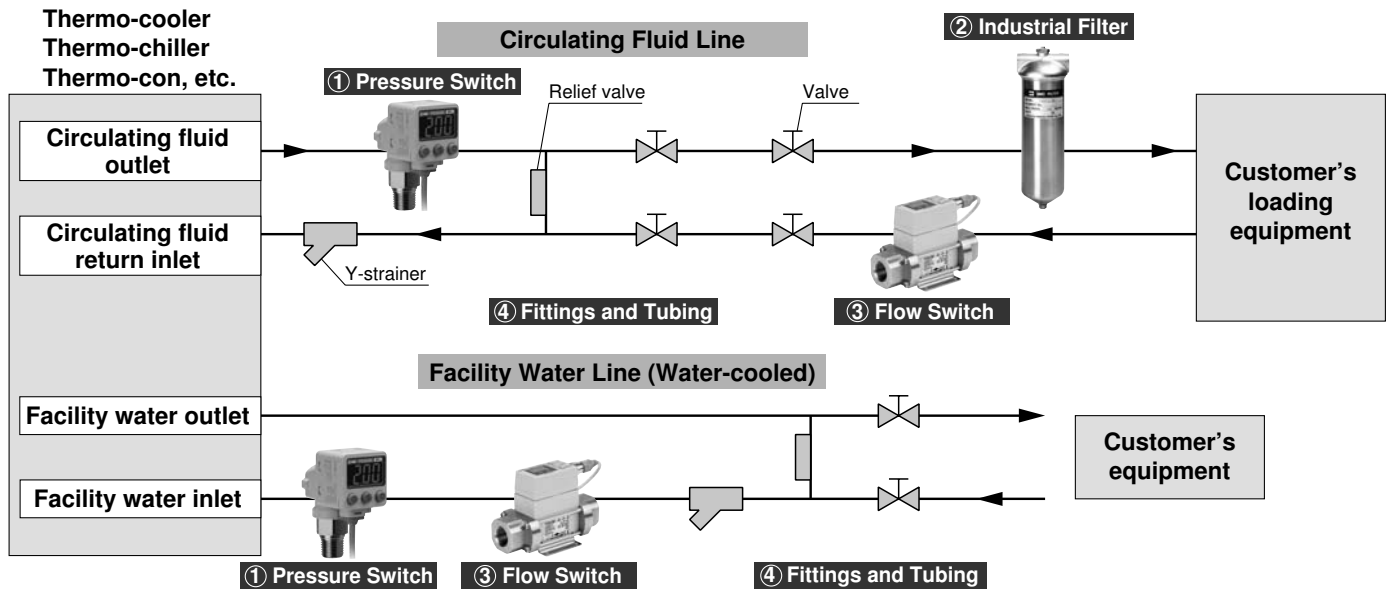

Refer to Best Pneumatics No. 6 for details.

① Pressure Switch: Monitors pressure of the circulating fluid and facility water.

2-Color Display High-Precision Digital Pressure Switch *ISE80*



Series	Type	Rated pressure range
ISE80	Positive pressure	-0.100 to 1.000 MPa
Features	<ul style="list-style-type: none"> • Suitable for a wide variety of fluids with stainless diaphragm • IP65 • RoHS compliant • Low leakage. VCR®, Swagelok® compatible fittings can be selected. • With one-touch fitting (Straight, Elbow) • Back piping, Underside piping 	

Pressure Sensor for General Fluids *PSE56*

Separate type sensor



Series	Type	Rated pressure range
PSE564	Positive pressure	0 to 500 kPa
PSE560	Positive pressure	0 to 1 MPa
Features	<ul style="list-style-type: none"> • Wetted parts: Stainless steel 316L • IP65 • Suitable for a wide variety of fluids • Analog output (voltage/current) • Low leakage. VCR®, Swagelok® compatible fittings can be selected. 	

Multi-Channel Digital Pressure Sensor Controller *PSE200*

Separate type monitor



Series	Features
PSE200	<ul style="list-style-type: none"> • Four sensors can be connected. • Applicable sensors: PSE53□, 54□, 56□ • Capable of controlling various different applications from one controller • 4 inputs, 5 outputs

2-Color Display Digital Pressure Sensor Controller *PSE300*

Separate type monitor



Series	Features
PSE300	<ul style="list-style-type: none"> • Applicable sensors: PSE53□, 54□, 550, 56□ • Compatible with voltage input and current input • Response time: 1 ms • Space-saving, capable of vertical and horizontal contact mounting • Panel mount, Bracket, DIN rail mount

Refer to Best Pneumatics No. 7 for details.

② Industrial Filter: Filters the circulating fluid and facility water.

Industrial Filter/Vessel Series *FGD*



Series	Port size	Max. operating pressure	Temperature (°C)
FGD	Rc 3/8, 1/2, 3/4	0.7, 1 MPa	Max. 80
Features	<ul style="list-style-type: none"> • Ideal for low-flow filtration (Max. 60 ℓ/min) • Possible to select the antistatic specification (FGDE, FGDF). 		

High-Precision Filter for Fluid *FGH*



Series	Port size	Max. operating pressure	Temperature (°C)
FGH	Rc 3/8 to 1	1 MPa	Max. 80
Features	<ul style="list-style-type: none"> • Filtration efficiency: Removing over 99% 		

Quick Change Filter *FQ1*



Series	Port size	Max. operating pressure	Temperature (°C)
FQ1	Rc 1/2, 3/4, 1	1 MPa	Max. 80
Features	<ul style="list-style-type: none"> • Ideal for low flow filtration (Max. 30 ℓ/min) • No tools required • Takes only 60 seconds for element replacement 		

Refer to Best Pneumatics No. 6 for details.

③ Flow Switch: Monitors the flow rate of the circulating fluid and facility water.

Digital Flow Switch for Water *PF2W*

Integrated type



Monitor

Sensor

Separate type

Series	Set flow rate range (ℓ/min)
PF2W	0.5 to 4
	2 to 16
	5 to 40
	10 to 100
Features	<ul style="list-style-type: none"> • Integrated type and Separate monitor type are available. • Switch output, Accumulated pulse output, Analog output • Capable of switching back and forth between cumulative and instantaneous flow • Capable of operating at temperatures as high as 90°C • IP65

Digital Flow Switch for Deionized Water and Chemicals *PF2D*

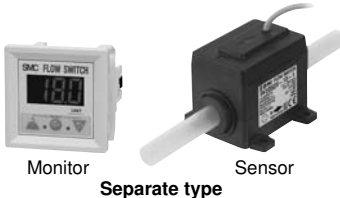

Monitor

Sensor

Separate type

Series	Set flow rate range (ℓ/min)
PF2D	0.4 to 4
	1.8 to 20
	4.0 to 40
Features	<ul style="list-style-type: none"> • Body sensor: New PFA, Tube: Super PFA • Low-particle generation, Excellent flow-through characteristics

4-Channel Flow Monitor *PF2□200*

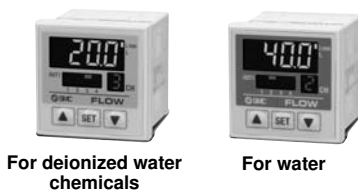

For deionized water chemicals

For water

Series	Applicable sensor	Set flow rate range (ℓ/min)
PF2W200/201	For water	PF2W5
		0.35 to 4.50
		1.7 to 17.0
		3.5 to 45.0
PF2D200/201	For deionized water/chemicals	PF2D5
		0.25 to 4.50
		1.3 to 21.0
		2.5 to 45.0
Features	<ul style="list-style-type: none"> • One controller can handle four units' worth of flow volume maintenance. • Four different flow ranges can be connected to one controller. 	

Related Products

Refer to Best Pneumatics No. 6 for details.

④ Fittings and Tubing

S Coupler

Series KK

- Fluid: **Air, Water**
- Applicable tubing O.D.: **ø3.2 to ø16**
- Applicable hose I.D./O.D.: **5/8 to 11/16**
- Port size: **M5 to 25A(3/4)**



S Coupler/Stainless Steel (Stainless Steel 304)

Series KKA

- Fluid: **Air, Water**
- Port size: **6A to 50A (1/8 to 11/2)**



Brass One-touch Fittings

Series KQB

- Fluid: **Air, Water**
- Applicable tubing O.D.: **ø4 to ø12**



Stainless Steel 316 One-touch Fittings

Series KQG

- Fluid: **Air, Water, Steam**
- Applicable tubing O.D.: **ø4 to ø12**



Stainless Steel 316 Insert Fittings

Series KFG

- Fluid: **Air, Water, Steam**
- Applicable tubing O.D.: **ø4 to ø12**



Fluoropolymer Fittings

Series LQ

- Fluid: **Deionized water, Chemicals, etc.**
(Please contact SMC for details.)
- Applicable tubing O.D.: **ø3 to ø25**



Tubing

Series T□

Series	Material	Fluid	O.D.
T	Nylon	Air, Water	ø4 to ø16
TU	Polyurethane	Air, Water	ø4 to ø16
TH	FEP (Fluoropolymer)	Air, Water, Inert gas	ø4 to ø12
TD	Modified PTFE (Soft fluoropolymer)	Air, Water, Inert gas	ø4 to ø12
TL	Super PFA	Deionized water, Chemicals, etc. <small>Note)</small>	ø4 to ø19

Length: Rolls up to 500 m in length are available, but please contact SMC for details because the maximum roll length varies depending on the tubing material and outer diameter. (Available with made-to-order specifications)

Note) Please contact SMC for details.

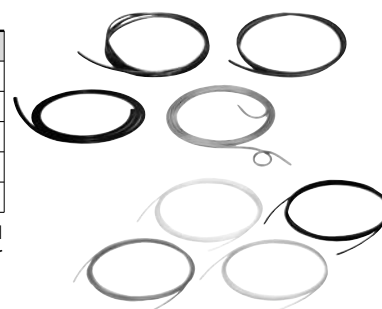

Temperature Control Equipment Warranty

1. Conditions of warranty

When a nonconformance should take place to our temperature control equipment, we will repair the unit without charge in accordance with our current terms and conditions.

This free repair covers the replacement of all nonconforming parts, their adjustment and checks. Please note that the disassembled parts will be the property of SMC.

2. Period of warranty

The warranty period of the product is 1 year in service or 1.5 years after the product is delivered.

3. Items out of warranty

The following cases are not subject to warranty.

1. Nonconformance caused by implementing no check-up (daily check-up, regular check-up) specified by SMC.
2. Nonconformance caused by the usage other than stipulated in the operating manual or outside the specification designated by SMC.
3. Nonconformance caused by remodeling which is not permitted by SMC.
4. Nonconformance caused by the usage other than the specified circulating fluid or facility water.
5. Nonconformance caused by elapsing. (painted surface, plated surface discolored naturally)
6. Sensuous phenomenon which is not affected functionally (sound, noise, vibration, etc.)
7. Nonconformance caused by natural disasters such as earthquake, typhoon, water disaster, accidents, or fire hazard.
8. Nonconformance caused by the installation environment stipulated in the operating manual.
9. Nonconformance caused by no observation to the following 5, "Items to be observed by customer."

4. Exemption from liability

1. Cost for daily check-up, regular check-up.
2. Cost for repair by a third party other than the designated distributors or agents.
3. Cost for moving this unit and installation or dislocation.
4. Cost for replacement or replenishment of the component parts or liquid other than specified.
5. Cost for inconvenience or loss caused by not being able to use the unit. (Telephone charge, warranty for job suspension, commercial loss, etc.)
6. Cost or compensation, etc. stipulated other than the above 1. "Conditions of warranty."

5. Items to be observed by customer

In order to use this product safely, the correct usage and check-up by customer are necessary.

Please be sure to observe the following things. Please note that we may decline the repair request upon warranty in case that the following things are not observed.

- 1) Use the unit in accordance to the proper handling as mentioned in the operating manual.
- 2) Conduct inspection and maintenance (daily check-up, regular check-up) as mentioned in the operating manual.
- 3) Record the inspection and maintenance results as mentioned in the operating manual.

6. How to ask a repair upon warranty

When a warranty repair is requested, please contact the nearest sales distributor.

With this, we will repair the unit upon warranty.

We promise a repair for free on the basis of the above mentioned periods or terms. Therefore, nonconformance occurred after the warranty period will be charged in principle.





Safety Instructions

These safety instructions are intended to prevent hazardous situations and/or equipment damage. These instructions indicate the level of potential hazard with the labels of “**Caution**,” “**Warning**” or “**Danger**.” They are all important notes for safety and must be followed in addition to International Standards (ISO/IEC), Japan Industrial Standards (JIS)*1) and other safety regulations*2).

- * 1) ISO 4414: Pneumatic fluid power – General rules relating to systems.
- ISO 4413: Hydraulic fluid power – General rules relating to systems.
- IEC 60204-1: Safety of machinery – Electrical equipment of machines. (Part 1: General requirements)
- ISO 10218-1992: Manipulating industrial robots -Safety.
- JIS B 8370: General rules for pneumatic equipment.
- JIS B 8361: General rules for hydraulic equipment.
- JIS B 9960-1: Safety of machinery – Electrical equipment of machines. (Part 1: General requirements)
- JIS B 8433-1993: Manipulating industrial robots - Safety.
- etc.
- * 2) Labor Safety and Sanitation Law, etc.

 **Caution:** Operator error could result in injury or equipment damage.

 **Warning:** Operator error could result in serious injury or loss of life.

 **Danger :** In extreme conditions, there is a possibility of serious injury or loss of life.

Warning

1. The compatibility of the product is the responsibility of the person who designs the equipment or decides its specifications.

Since the product specified here is used under various operating conditions, its compatibility with specific equipment must be decided by the person who designs the equipment or decides its specifications based on necessary analysis and test results. The expected performance and safety assurance of the equipment will be the responsibility of the person who has determined its compatibility with the product. This person should also continuously review all specifications of the product referring to its latest catalog information, with a view to giving due consideration to any possibility of equipment failure when configuring the equipment.

2. Only personnel with appropriate training should operate machinery and equipment.

The product specified here may become unsafe if handled incorrectly. The assembly, operation and maintenance of machines or equipment including our products must be performed by an operator who is appropriately trained and experienced.

3. Do not service or attempt to remove product and machinery/equipment until safety is confirmed.

1. The inspection and maintenance of machinery/equipment should only be performed after measures to prevent falling or runaway of the driven objects have been confirmed.
2. When the product is to be removed, confirm that the safety measures as mentioned above are implemented and the power from any appropriate source is cut, and read and understand the specific product precautions of all relevant products carefully.
3. Before machinery/equipment is restarted, take measures to prevent unexpected operation and malfunction.

4. Contact SMC beforehand and take special consideration of safety measures if the product is to be used in any of the following conditions.

1. Conditions and environments outside of the given specifications, or use outdoors or in a place exposed to direct sunlight.
2. Installation on equipment in conjunction with atomic energy, railways, air navigation, space, shipping, vehicles, military, medical treatment, combustion and recreation, or equipment in contact with food and beverages, emergency stop circuits, clutch and brake circuits in press applications, safety equipment or other applications unsuitable for the standard specifications described in the product catalog.
3. An application which could have negative effects on people, property, or animals requiring special safety analysis.
4. Use in an interlock circuit, which requires the provision of double interlock for possible failure by using a mechanical protective function, and periodical checks to confirm proper operation.



Safety Instructions

Caution

The product is provided for use in manufacturing industries.

The product herein described is basically provided for peaceful use in manufacturing industries.

If considering using the product in other industries, consult SMC beforehand and exchange specifications or a contract if necessary. If anything is unclear, contact your nearest sales branch.

Limited Warranty and Disclaimer/Compliance Requirements

The product used is subject to the following “Limited Warranty and Disclaimer” and “Compliance Requirements”. Read and accept them before using the product.

Limited Warranty and Disclaimer

1. The warranty period of the product is 1 year in service or 1.5 years after the product is delivered.*3)

Also, the product may have specified durability, running distance or replacement parts. Please consult your nearest sales branch.

2. For any failure or damage reported within the warranty period which is clearly our responsibility, a replacement product or necessary parts will be provided.

This limited warranty applies only to our product independently, and not to any other damage incurred due to the failure of the product.

3. Prior to using SMC products, please read and understand the warranty terms and disclaimers noted in the specified catalog for the particular products.

* 3) Vacuum pads are excluded from this 1 year warranty.

A vacuum pad is a consumable part, so it is warranted for a year after it is delivered.

Also, even within the warranty period, the wear of a product due to the use of the vacuum pad or failure due to the deterioration of rubber material are not covered by the limited warranty.

Compliance Requirements

When the product is exported, strictly follow the laws required by the Ministry of Economy, Trade and Industry (Foreign Exchange and Foreign Trade Control Law).



Temperature Control Equipment Precautions 1

Be sure to read this before handling. Refer to back pages 1 and 2 for Safety Instructions and the main text for Specific Product Precautions on every series.

Selection

Warning

1. Confirm the specifications.

Fully understand the applications, environment, fluids and other operating conditions. Use this product within the specified range shown in this catalog. Using outside the specified range can cause injury, damage, or malfunction. When in doubt, please contact SMC beforehand.

2. Secure the performance margin.

When you consider the product's cooling/heating performance or flow characteristics, allowance must be made because there are heat loss from the piping, etc. or pressure drop.

Operating Environment / Storage Environment

Warning

1. Observe the ambient temperature range.

The operating ambient temperature range must be within the specification range shown in this catalog.
Use caution because using beyond the range will lead to damage, breakage or malfunction.

2. Avoid using and storing in the following environment because it will lead to malfunction.

1. In locations where water, water steam, salt water, and oil may splash on the product.
2. In locations where a large amount of particles are airborne.
3. In locations with an atmosphere of corrosive or explosive gases, solvents, or chemicals.
(This product is not explosion proof.)
4. In locations which receive direct sunlight or radiated heat.
(Protect from direct sunshine to avoid the resin from deteriorating by ultraviolet rays or increasing the temperature.)
5. In locations where temperature substantially changes.
6. In locations where there is a heat source nearby and the ventilation is poor.
(Insulate the heat source or ventilate well to avoid damages caused by the heat or temperature increase, such as softening.)
7. In locations where condensation occurs.
8. In locations where strong magnetic noise occurs.
(In locations where strong electric fields, strong magnetic fields and surge voltage occur.)
9. In locations where static electricity occurs, or conditions which make the product discharge static electricity.
10. In locations where high frequency occurs.
11. In locations where damage is likely to occur due to lightning.
12. In locations where impacts or vibrations occur.
13. In conditions where a massive force strong enough to deform the product is applied or a weight from a heavy object is applied.
14. In locations more than 1000 m in altitude (except storage, transportation).

Fluid

Warning

1. Type of fluids

1. The operating fluids must be used within the specified range shown in this catalog.
Please consult with SMC when using the product with other fluids.
2. Depending on the combination, foreign matter, chemical leakage and catalysts may change the piping material and operating fluid qualities.
3. When solid foreign objects may be mixed with a fluid, install a filter to remove them.

Transportation / Transfer / Movement

Warning

1. Product transfer should be performed by a knowledgeable and experienced person.

Especially, transferring a heavy object is dangerous.
Use adequate caution to prevent falling down or dropping accidents from occurring.

2. Avoid transportation in the following environment because it will lead to breakage.

1. In conditions where strong shock and vibrations occur.
2. In operating and storage environments other than those specified.

3. Caution when transferring a heavy object

This product is heavy. Use adequate caution to avoid injury when picking up and setting down the product, and falling and dropping accidents should be avoided.

4. Before moving this product, remove operating fluid, facility water from the inside of this product.

Mounting / Installation

Warning

1. Installation should be performed by a knowledgeable and experienced person.

Especially, installation of a heavy object is dangerous.
Use adequate caution to avoid falling and dropping accidents from occurring.

Caution

1. Provide space for ventilation and maintenance.

Provide enough space for the ventilation requirement of each equipment. Otherwise, a cooling malfunction or operation stoppage may occur. Also, provide space required for maintenance.

2. Verify the mounting orientation.

Mount and install horizontally.



Temperature Control Equipment Precautions 2

Be sure to read this before handling. Refer to back pages 1 and 2 for Safety Instructions and the main text for Specific Product Precautions on every series.

Piping

Warning

- 1. For this product and future equipment, design of the piping system should be performed by a knowledgeable and experienced person.**
- 2. Work performed on the piping should be done by a knowledgeable and experienced person.**
If work performed on the piping is done by a less knowledgeable and inexperienced person, it will likely lead to operating fluid leakage, etc.
- 3. Thoroughly read the operating manual.**
Read the operating manual completely before piping. Also, keep the manual where it can be referred to as necessary.
- 4. Tighten threads with the proper tightening torque.**

When installing piping, etc., follow the given torque levels below.

Piping Tightening Torque

Connection thread	Proper tightening torque (N·m)
M5	1.5 to 2
Rc 1/8	7 to 9
Rc 1/4	12 to 14
Rc 3/8	22 to 24
Rc 1/2	28 to 30
Rc 3/4	28 to 30
Rc 1	36 to 38
Rc 1 1/4	40 to 42
Rc 1 1/2	48 to 50
Rc 2	48 to 50

5. Confirm the leakage of fluid.

Confirm that the hose or tubing is not pulled out and that there is no leakage in the fitted parts.

Caution

- 1. Refer to the Fittings and Tubing Precautions (Best Pneumatics No. 6) for handling one-touch fittings.**
- 2. Preparation before piping**
Before piping is connected, it should be thoroughly blown out with air (flushing) or washed to remove chips, cutting oil and other debris from inside the pipe.
- 3. Use caution regarding the flowing direction of the fluid.**
When installing piping to a product, do not mistake the flow direction of supply port, etc. Check "IN" and "OUT" or labels and the operating manual before connection.
- 4. Sealant tape**
When installing piping or fitting into a port, ensure that sealant material does not enter the port internally. When using sealant tape, leave 1.5 to 2 threads exposed on the end of pipe/fitting.
- 5. Take countermeasures against condensation.**
Depending on the operating condition, condensation may occur in the piping. In such a case, take countermeasures such as installing insulation material, etc.



Temperature Control Equipment Precautions 3

Be sure to read this before handling. Refer to back pages 1 and 2 for Safety Instructions and the main text for Specific Product Precautions on every series.

Electrical Wiring

Warning

1. Electrical wiring job should be performed by a knowledgeable and experienced person.

Power supply facilities and wiring works should be implemented in accordance with the electric facilities technical standards and provisions and conducted correctly.

2. Mounting a dedicated ground fault circuit interrupter

As a countermeasure against current leakage, install a ground fault circuit interrupter (GFCI) in the main power supply.

3. Check the power supply.

If this product is used with voltages other than specified, it will likely lead to a fire or an electrical shock. Before wiring, confirm the voltage, volume, and frequency.

Confirm that the voltage fluctuation is within $\pm 10\%$ of the specified value.

4. Grounding

Be certain to ground (frame ground) with class D grounding (grounding resistance of 100 Ω or less).

Can be grounded with the PE line of the power supply cable.

Also, do not use together with equipment that generates a strong electrical magnetic noise or high frequency noise.

5. Wiring cable should be handled with care.

Do not bend, twist or stretch the cord or cable.

6. Wire with an applicable size cable and terminal.

In the event of attaching a power supply cable, use a cable and terminal size which is suitable for the electrical current of each product.

Forcibly mounting with an unsuitable size cable will likely result in a fire.

7. Avoid wiring the signal line and power line in parallel.

Since there may be a possibility of malfunction from noise, avoid parallel wiring between the temperature sensor line, communication line, signal line of alarm line, etc. and the power line and high voltage line. Also, do not place them in the same wiring tube.

Facility Water Supply

(Water-cooled refrigeration)

Warning

1. Be certain to supply the facility water.

1. Prohibition of water-cut operation, very little flow rate of water operation.

Do not operate under the condition that there is no facility water or where there is very little flow rate of water is flowing. In this kind of operation, facility water temperature may become extremely higher. It is dangerous enough the material of hose may soften and burst when the piping supplying the facility water is connected with hose.

2. Actions to be taken when an emergency stop occurs due to high temperature.

In case a stop occurs due to extremely high temperature resulting from a decrease in the facility water flow rate, do not immediately flow facility water. It is dangerous enough the material of hose may soften and burst when the piping supplying the facility water is connected with hose.

First, naturally let it cool down by removing the cause of the flow rate reduction. Secondly, confirm that there is no leakage again.

Caution

1. Facility water quality

1. Use the facility water within the specified range as shown below.

When using with other fluid than facility water, please consult with SMC.

2. When it is likely that foreign objects may enter the fluid, install a filter (20 mesh or equivalent).

Facility Water Quality Standard

The Japan Refrigeration and Air Conditioning Industry Association

JRA GL-02-1994 "Cooling water system – Circulation type – Circulating water"

	Item	Unit	Standard value
Standard item	pH (at 25°C)	—	6.5 to 8.2
	Electrical conductivity (25°C)	[μ S/cm]	100* to 800*
	Chloride ion (Cl ⁻)	[mg/L]	200 or less
	Sulfuric acid ion (SO ₄ ²⁻)	[mg/L]	200 or less
	Acid consumption amount (at pH4.8)	[mg/L]	100 or less
	Total hardness	[mg/L]	200 or less
	Calcium hardness (CaCO ₃)	[mg/L]	150 or less
Reference item	Ionic state silica (SiO ₂)	[mg/L]	50 or less
	Iron (Fe)	[mg/L]	1.0 or less
	Copper (Cu)	[mg/L]	0.3 or less
	Sulfide ion (S ₂ ⁻)	[mg/L]	Should not be detected.
	Ammonium ion (NH ₄ ⁺)	[mg/L]	1.0 or less
	Residual chlorine (Cl)	[mg/L]	0.3 or less
	Free carbon (CO ₂)	[mg/L]	4.0 or less

* In the case of [M Ω ·cm], it will be 0.00125 to 0.01.