

# Wedge Cam Operation Slide Guide

## Series **MHK2**

Air Gripper/2-Finger Type  $\phi 12$ ,  $\phi 16$ ,  $\phi 20$ ,  $\phi 25$



MHZ

MHF

MHL

MHR

**MHK**

MHS

MHC

MHT

MHY

MHW

-X□

MRHQ

MA

D-□

### Load Resistant, Dust Cover for Adverse Environments

#### 2 types of finger materials

Standard: Carbon steel

Option: Stainless steel

#### 3 types of dust cover materials

Standard: Chloroprene rubber (CR) ..... Black

Optional: Fluororubber (FKM) ..... Black

Silicon rubber (Si) ..... White

# Wedge Cam Operation Provides Dust Cover for Adverse

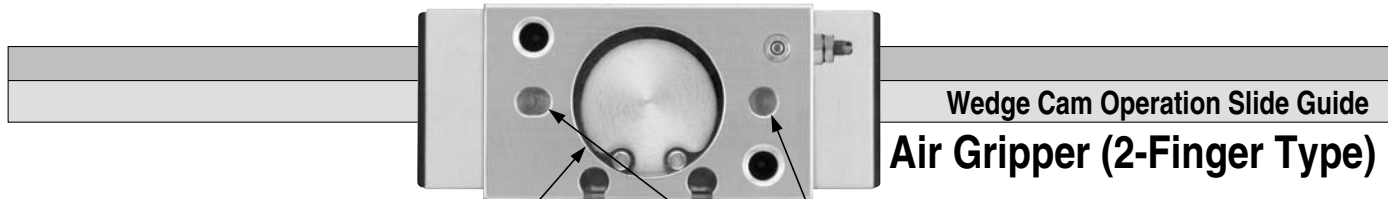

## Mounting repeatability

Centering accuracy  $\pm 0.1$  mm

## Pin hole for positioning on top side

## Auto switch mountable

Grooves for auto switch are located on one side. Easy handling for adjustment and installation.

## Built-in adjustment needle for finger speed

Possible to adjust the speed for finger closing direction.

## Wedge cam structure

The wedge structure allows no lateral vibration along stroke direction once work is held.

## High rigidity

Slide type guide bearing enables highly rigid finger motion.

## High precision repeatability: $\pm 0.01$ mm

## Improved performance

Incorporation of dust cover prevents dust, water, etc. from entering the body and avoids generating dust and releasing grease from air gripper.

## 2 types of finger materials are available for different applications.

Standard: Carbon steel  
Option: Stainless steel

## 3 types of dust covers are available for use in different environments.

Standard: Chloroprene rubber (CR) ..... Black  
Optional: Fluororubber (FKM) ..... Black  
              Silicon rubber (Si) ..... White

## Longer strokes are now standard.

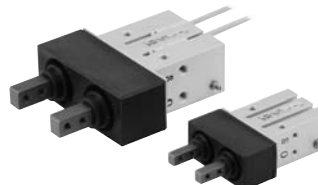

Bore size (mm)	Opening/Closing stroke (mm)	
	Long stroke	Standard stroke
12	11	4
16	14	6
20	18	10
25	22	14

# High Precision and Rigidity. Environmental Conditions.

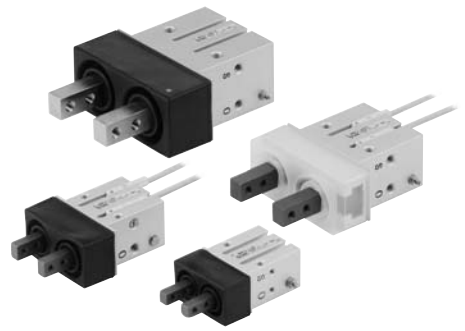

## Series *MHK2*

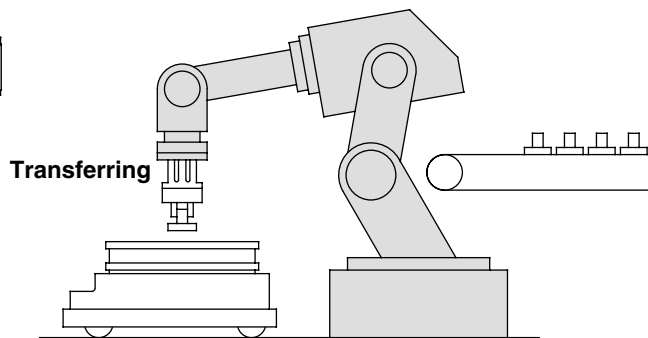
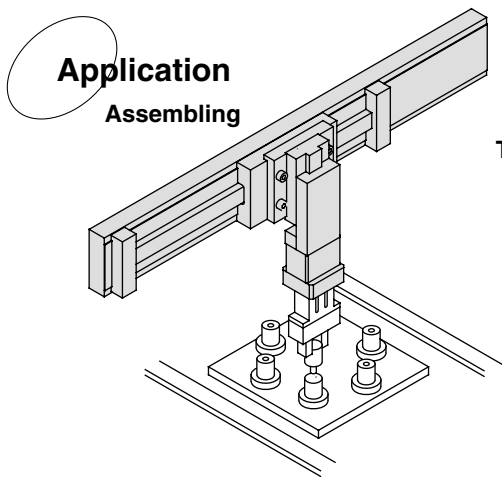

Loading/Unloading work into machine tools

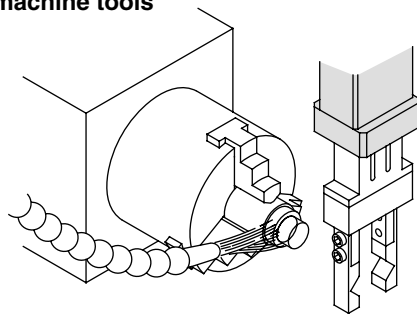

### Universal mounting

Axial mounting

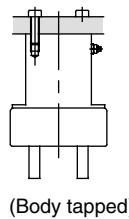

Vertical mounting

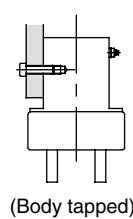

Lateral mounting

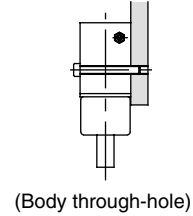
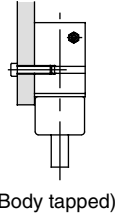

Interchangeable with Series MHQG2

### Series Variations

Series	Model	Bore size (mm)	Opening/Closing stroke (mm)	Option	
Parallel opening/closing	Standard type Series <b>MHK2</b>	<b>MHK2-12</b> □	12	4	<ul style="list-style-type: none"> <li>■ Finger option</li> <li>Carbon steel (Standard), Stainless steel</li> <li>■ Dust cover option</li> <li>Chloroprene rubber (Standard)</li> <li>Fluororubber</li> <li>Silicon rubber</li> <li>■ Auto switch</li> <li>Solid state switch</li> <li>D-M9N(V), D-M9P(V)</li> <li>D-M9B(V), Water resistant</li> <li>(2-color indication), D-M9□A(V)</li> </ul>
		<b>MHK2-16</b> □	16	6	
		<b>MHK2-20</b> □	20	10	
		<b>MHK2-25</b> □	25	14	
	Long stroke type Series <b>MHKL2</b>	<b>MHKL2-12</b> □	12	11	
		<b>MHKL2-16</b> □	16	14	
		<b>MHKL2-20</b> □	20	18	
		<b>MHKL2-25</b> □	25	22	

MHZ

MHF

MHL

MHR

**MHK**

MHS

MHC

MHT

MHY

MHW

-X□

MRHQ

MA

D-□

# Wedge Cam Operation Slide Guide

## Air Gripper/2-Finger Type

# Series *MHK2*

ø12, ø16, ø20, ø25

### How to Order

**Standard type**     **MHK 2 - 20 D 1 F - M9B**     **Long stroke type**     **MHKL 2 - 20 D 1 F - M9B**

**Number of fingers**

2	2 fingers
---	-----------

**Bore size**

12	12 mm
16	16 mm
20	20 mm
25	25 mm

**Action**

D	Double acting
S	Single acting (Normally open)
C	Single acting (Normally closed)

**Finger material**

Nil	Carbon steel
1	Stainless steel

**Auto switch**

Nil	Without auto switch (Built-in magnet)
-----	---------------------------------------

**Number of auto switches**

Nil	2 pcs.
S	1 pc.

**Dust cover material**

Nil	Chloroprene rubber (CR)
F	Fluororubber (FKM)
S	Silicon rubber (Si)

**Made to Order**  
Refer to page 523 for details.

### Applicable Auto Switch/Refer to pages 761 to 809 for further information on auto switches.

Type	Special function	Electrical entry	Indicator light	Wiring (Output)	Load voltage		Auto Switch model		Lead wire length (m)*				Pre-wired connector	Applicable load	
					DC	AC	Electrical entry direction		0.5 (Nil)	1 (M)	3 (L)	5 (Z)			
							Perpendicular	In-line							
Solid state switch	Water resistant (2-color indication)	Grommet	Yes	3-wire (NPN)	24 V	5 V, 12 V	—	M9NV	M9N	●	●	●	○	○	IC circuit Relay, PLC
				3-wire (PNP)				M9PV	M9P	●	●	●	○	○	
				2-wire				M9BV	M9B	●	●	●	○	○	
				3-wire (NPN)				M9NAV	M9NA	○	○	○	○	○	
				3-wire (PNP)				M9PAV	M9PA	○	○	●	○	○	
				2-wire				M9BAV	M9BA	○	○	●	○	○	

\* Lead wire length symbols: 0.5 m ..... Nil (Example) M9NW  
 1 m ..... M (Example) M9NWM  
 3 m ..... L (Example) M9NWL  
 5 m ..... Z (Example) M9NWZ

\* Auto switches marked with a "○" symbol are produced upon receipt of order.

Note 1) Take note of hysteresis with 2-color indication type switches.  
 Refer to "Auto Switch Hysteresis" on page 536.

Note 2) Refer to pages 761 to 809 for further information on auto switches.

## Specifications



### JIS Symbol

Double acting

Single acting

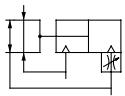

Normally open

Normally closed

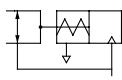
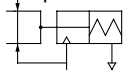

Fluid		Air
Operating pressure	Double acting	
	Single acting	0.1 to 0.6 MPa
		Normally open
		Normally closed
Ambient and fluid temperature		-10 to 60°C
Repeatability		±0.01 mm
Lubrication		Not required
Action		Double acting/Single acting
Auto switch (Option) <small>Note)</small>		Solid state auto switch (3-wire, 2-wire)



Note) Refer to pages 761 to 809 for further information on auto switches.

## Option

Finger material	Carbon steel (Standard), Stainless steel
Dust cover material	Chloroprene rubber (CR) (Standard), Fluoro rubber (FKM), Silicon rubber (Si)

## Model

### Series MHK2/Standard Type

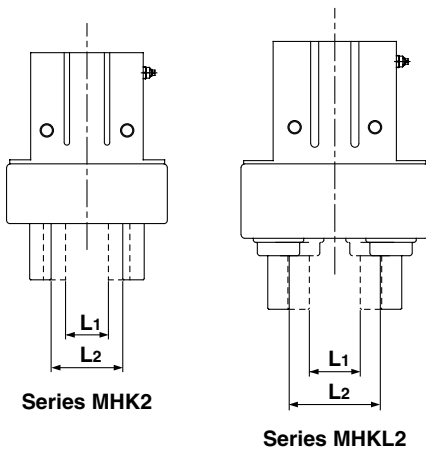

Action	Model	Bore size (mm)	Max. operating frequency (c.p.m)	Effective gripping force per finger (N) <small>Note)</small>	Opening/Closing stroke (mm) L2-L1	Width at closing (mm) L1	Width at opening (mm) L2	Mass (g)	
Double acting	MHK2-12D	12	120	External grip: 15 Internal grip : 16	4	9	13	75	
	MHK2-16D	16		External grip: 31 Internal grip : 36	6	14.6	20.6	113	
	MHK2-20D	20		External grip: 46 Internal grip : 56	10	16	26	235	
	MHK2-25D	25		External grip: 80 Internal grip : 86	14	19	33	440	
Single acting	Normally open	MHK2-12S		12	9	4	9	13	76
		MHK2-16S		16	23	6	14.6	20.6	114
		MHK2-20S		20	34	10	16	26	237
		MHK2-25S		25	58	14	19	33	443
	Normally closed	MHK2-12C		12	12	4	9	13	76
		MHK2-16C		16	25	6	14.6	20.6	115
		MHK2-20C		20	44	10	16	26	237
		MHK2-25C		25	73	14	19	33	443



### Made to Order

Refer to pages 683 to 713 for details.

Symbol	Specifications/Description
-X4	Heat resistance (100°C)
-X5	Fluororubber seal
-X7	Closing direction spring assist
-X12	Opening direction spring assist
-X39	With grease needle
-X41	Switch groove (Both-side type)
-X50	Without magnet
-X53	EPDM seal/Fluorine grease
-X63	Fluorine grease
-X64	Finger: Side tapped mounting
-X65	Finger: Through-hole mounting
-X77A	Dust cover adhesion
-X77B	Dust cover adhesion (Finger part only)
-X78A	Dust cover caulking
-X78B	Dust cover caulking (Finger part only)
-X79	Grease for food

### Series MHKL2/Long Stroke Type

Action	Model	Bore size (mm)	Max. operating frequency (c.p.m)	Effective gripping force per finger (N) <small>Note)</small>	Opening/Closing stroke (mm) L2-L1	Width at closing (mm) L1	Width at opening (mm) L2	Mass (g)	
Double acting	MHKL2-12D	12	90	External grip: 14 Internal grip : 16	11	9	20	104	
	MHKL2-16D	16		External grip: 27 Internal grip : 30	14	14.6	28.6	164	
	MHKL2-20D	20		External grip: 45 Internal grip : 53	18	16	34	312	
	MHKL2-25D	25		External grip: 79 Internal grip : 90	22	19	41	562	
	Single acting	Normally open		MHKL2-12S	12	9	11	9	20
MHKL2-16S				16	17	14	14.6	28.6	165
MHKL2-20S				20	32	18	16	34	314
Normally closed		MHKL2-25S		25	53	22	19	41	565
		MHKL2-12C		12	11	11	9	20	105
		MHKL2-16C		16	22	14	14.6	28.6	166
	MHKL2-20C	20	40	18	16	34	314		
	MHKL2-25C	25	63	22	19	41	565		



Note) At the pressure of 0.5 MPa, when gripping point L is 20 mm.

Single acting normally open: External holding force, Single acting normally closed: Internal gripping force.

Refer to "Effective Gripping Force" for the gripping force at each gripping position on pages 525 to 529.

# Series MHK2

## Construction

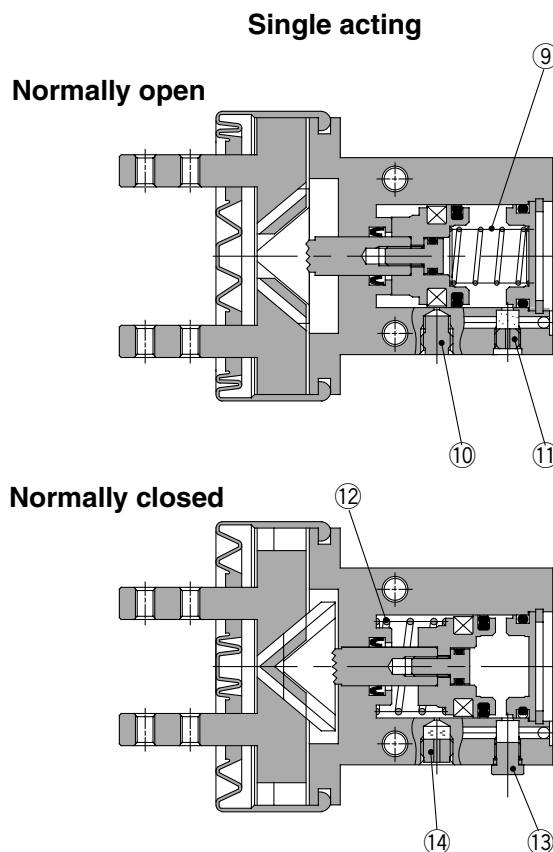
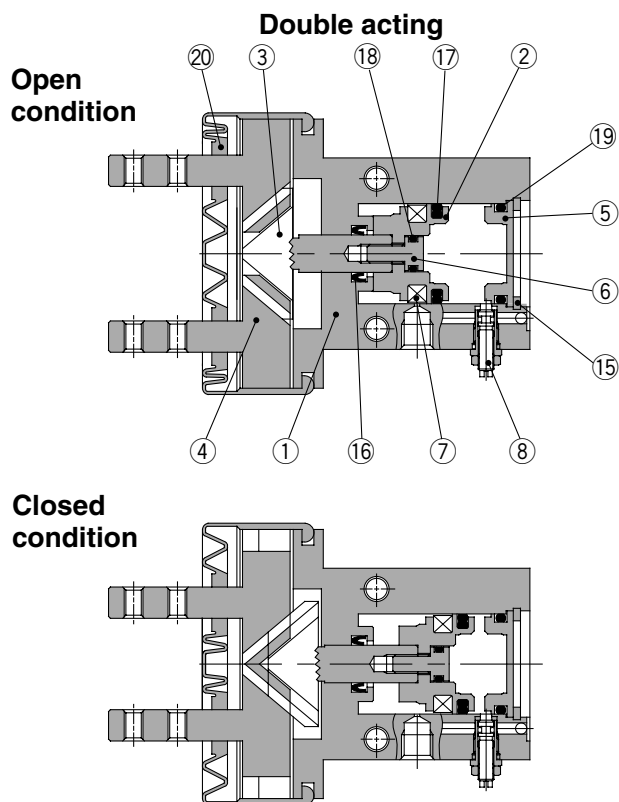

### Component Parts

No.	Description	Material	Note
1	<b>Body</b>	Aluminum alloy	Hard anodized
2	<b>Piston</b>	Aluminum alloy	Hard anodized
3	<b>Cam</b>	Carbon steel	Heat treated, Specially treated
4	<b>Finger</b>	Carbon steel	Heat treated, Specially treated
		Stainless steel 304	Option
5	<b>Cap</b>	Aluminum alloy	Hard anodized
6	<b>Piston bolt</b>	Stainless steel	
7	<b>Rubber magnet</b>	Synthetic rubber	

No.	Description	Material	Note
8	<b>Needle assembly</b>		
9	<b>N.O. spring</b>	Piano wire	
10	<b>Plug</b>	Brass	Electroless nickel plated
11	<b>Exhaust plug</b>	Brass	Electroless nickel plated
12	<b>N.C. spring</b>	Piano wire	
13	<b>Plug assembly</b>	Brass	Electroless nickel plated
14	<b>Exhaust plug A</b>	Brass	Electroless nickel plated
15	<b>Type C retaining ring</b>	Carbon steel	Nickel plated

### MHK2 Replacement Parts

Description		MHK2-12□	MHK2-16□	MHK2-20□	MHK2-25□	Main parts	
<b>Seal kit</b>		MHK12-PS	MHK16-PS	MHK20-PS	MHK25-PS	⑬⑭⑮⑯	
<b>Piston assembly</b>		MHK-A1201	MHK-A1601	MHK-A2001	MHK-A2501	②⑥⑦	
<b>Cam</b>		P3318103	P3318203	P3318303	P3318403	③	
<b>Finger</b>	Material	Carbon steel	P3318104	P3318204	P3318304	P3318404	④
		Stainless steel	P3318104-1	P3318204-1	P3318304-1	P3318404-1	
<b>Needle assembly</b>		MH-A1006				⑧	
<b>Dust cover</b>	Material	CR	MHK2-J12	MHK2-J16	MHK2-J20	MHK2-J25	⑳
		FKM	MHK2-J12F	MHK2-J16F	MHK2-J20F	MHK2-J25F	
		Si	MHK2-J12S	MHK2-J16S	MHK2-J20S	MHK2-J25S	

\* Order 2 pieces per one finger unit.

Replacement part/Grease pack part no.: MH-G01 (30 g)

### MHKL2 Replacement Parts

Description		MHKL2-12□	MHKL2-16□	MHKL2-20□	MHKL2-25□	Main parts	
<b>Seal kit</b>		MHK12-PS	MHK16-PS	MHK20-PS	MHK25-PS	⑬⑭⑮⑯	
<b>Piston assembly</b>		MHK-A1201	MHK-A1601	MHK-A2001	MHK-A2501	②⑥⑦	
<b>Cam</b>		P3318111	P3318211	P3318311	P3318411	③	
<b>Finger</b>	Material	Carbon steel	P3318112	P3318212	P3318312	P3318412	④
		Stainless steel	P3318112-1	P3318212-1	P3318312-1	P3318412-1	
<b>Needle assembly</b>		MH-A1006				⑧	
<b>Dust cover</b>	Material	CR	MHKL2-J12	MHKL2-J16	MHKL2-J20	MHKL2-J25	⑳
		FKM	MHKL2-J12F	MHKL2-J16F	MHKL2-J20F	MHKL2-J25F	
		Si	MHKL2-J12S	MHKL2-J16S	MHKL2-J20S	MHKL2-J25S	

\* Order 2 pieces per one finger unit.

Replacement part/Grease pack part no.: MH-G01 (30 g)

### Model Selection Example

#### Procedure



Workpiece form:  
Diameter x Length  
ø28 x 35 mm round bar

Workpiece diameter: From dimensions of model that has opening width 28 mm or more.  
**MHK2-25D**  
**MHKL2-16D**  
**MHKL2-20D**  
**MHKL2-25D**

Work mass: 0.17 kg

**Guidelines for the selection of the gripper with respect to component weight**

- Although conditions differ according to the workpiece shape and the coefficient of friction between the attachments and the workpiece, select a model that can provide a gripping force of 10 to 20 times the workpiece mass, or more.
- If high acceleration, deceleration or impact forces are encountered during motion, a further margin of safety should be considered.

Ex.) For setting the gripping force to be at least 20 times the workpiece mass:  
Required gripping force = 0.17 kg x 20 x 9.8 m/s<sup>2</sup> = 33 N

Gripping method:  
External gripping

Gripping point 40 mm

Operating pressure: 0.5 MPa

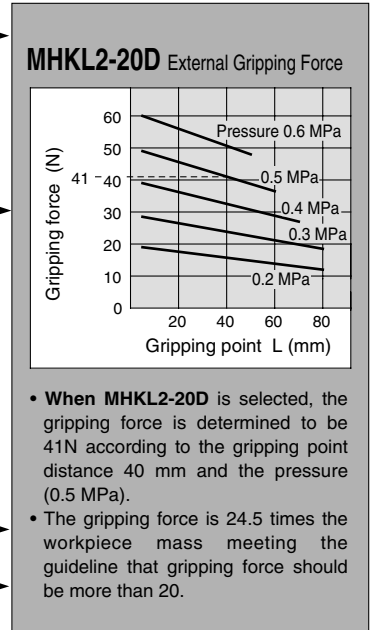

### Gripping Point

#### External grip

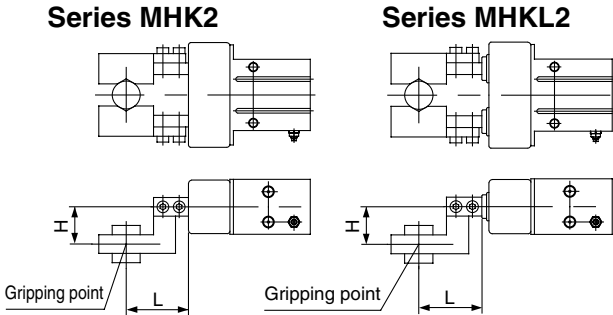

#### Internal grip

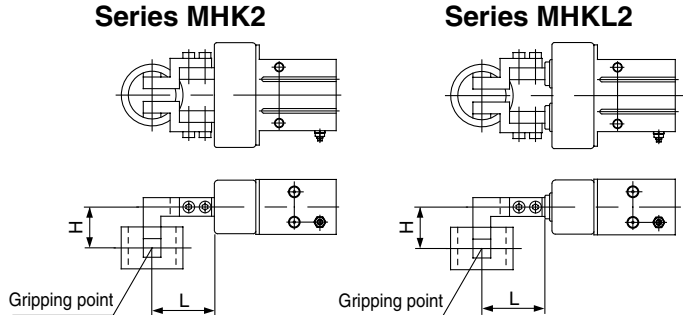

L: Gripping point distance  
H: Overhang distance

- Proper gripping points should be selected in accordance with the operating pressure. The distance to the gripping point L and the overhang distance H should be within the limited range given in the graphs below.
- When the gripping point distance becomes large, the finger attachment applies an excessively large load to the finger sliding section, causing excessive play of the fingers and possibly leading to premature failure.

### Gripping Point Range Limit

**MHK2-12** □  
**MHKL2-12** □

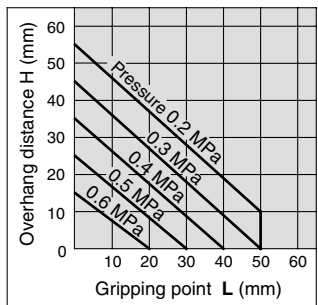

**MHK2-16** □  
**MHKL2-16** □

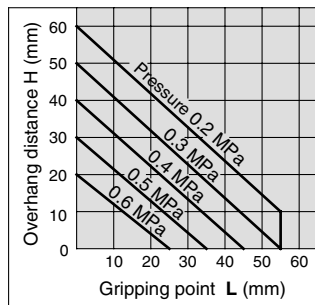

**MHK2-20** □  
**MHKL2-20** □

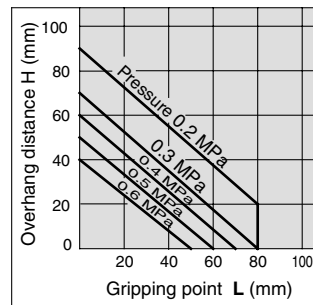

**MHK2-25** □  
**MHKL2-25** □

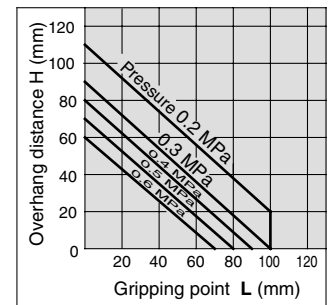

Note) Distance to the gripping point L of single acting type is shortened by spring return.  
Use air gripper within gripping force line shown for each pressure in effective gripping force graph.

- MHZ
- MHF
- MHL
- MHR
- MHK**
- MHS
- MHC
- MHT
- MHY
- MHW
- X □
- MRHQ
- MA
- D-□

# Series MHK2

## Effective Gripping Force: Series MHK2 Double Acting

- Indication of effective gripping force  
The effective gripping force shown in the graphs to the right is expressed as  $F$ , which is the thrust of one finger, when both fingers and attachments are in full contact with the work-piece as shown in the figure below.

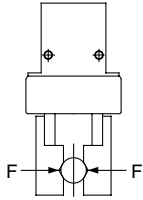

External grip  
Series MHK2

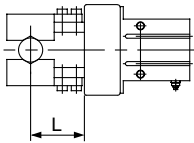

Internal grip  
Series MHK2

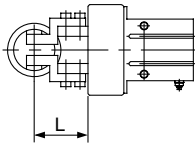

### External Grip

#### MHK2-12D

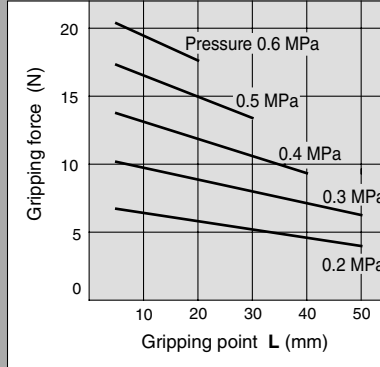

### Internal Grip

#### MHK2-12D

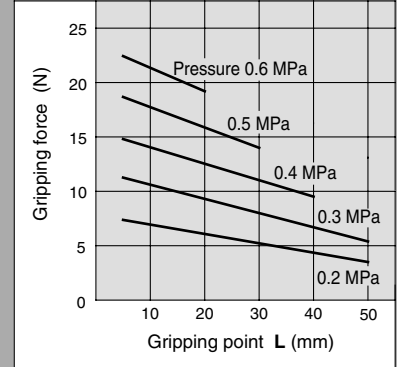

#### MHK2-16D

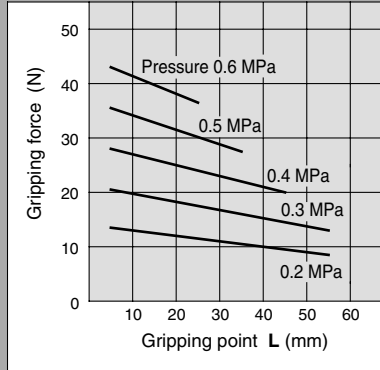

#### MHK2-16D

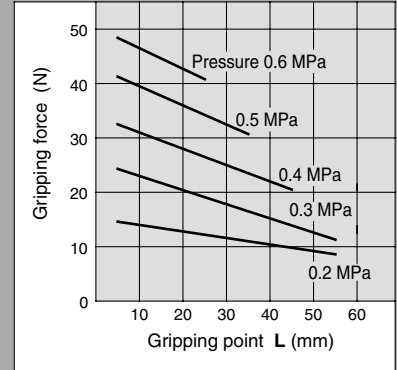

#### MHK2-20D

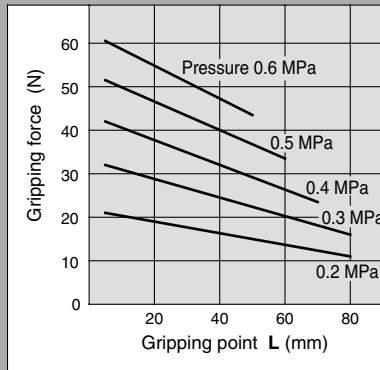

#### MHK2-20D

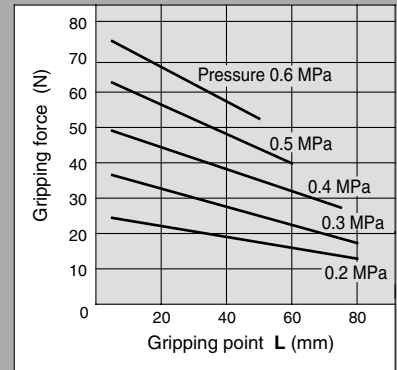

#### MHK2-25D

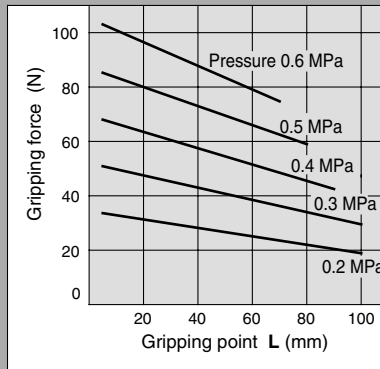

#### MHK2-25D

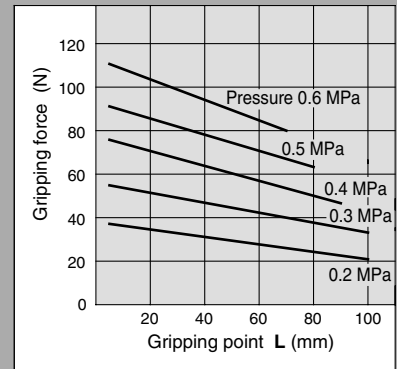



### Effective Gripping Force: Series MHKL2 Double Acting

• Indication of effective gripping force  
The effective gripping force shown in the graphs to the right is expressed as  $F$ , which is the thrust of one finger, when both fingers and attachments are in full contact with the workpiece as shown in the figure below.

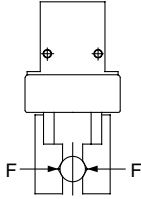

**External grip**  
Series MHKL2

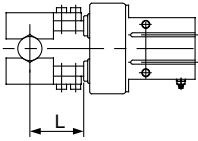

**Internal grip**  
Series MHKL2

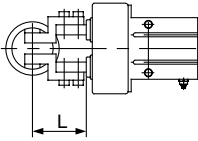

#### External Grip

##### MHKL2-12D

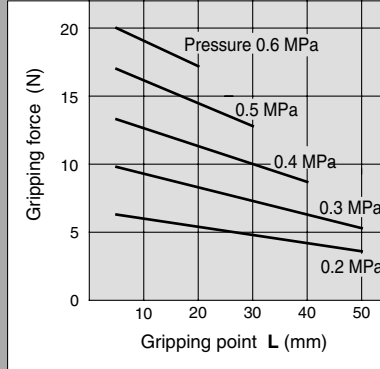

##### MHKL2-16D

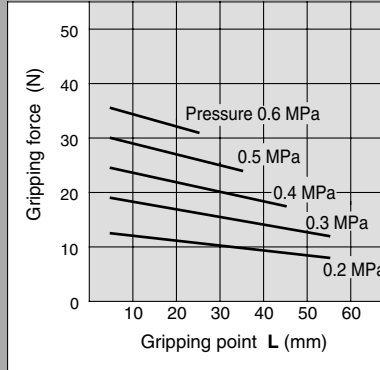

##### MHKL2-20D

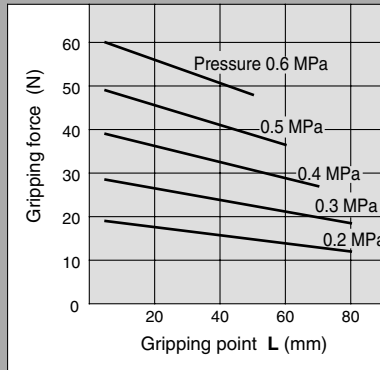

##### MHKL2-25D

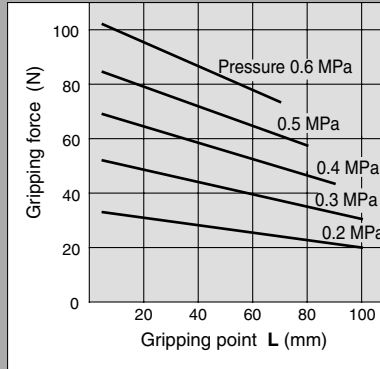

#### Internal Grip

##### MHKL2-12D

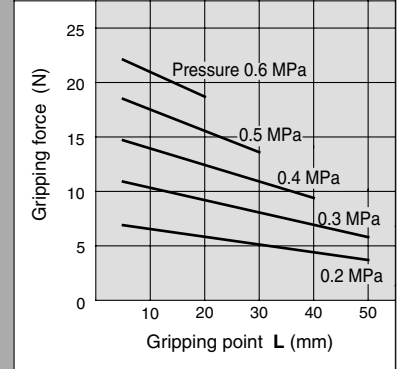

##### MHKL2-16D

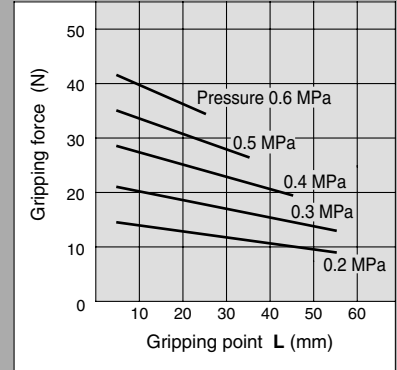

##### MHKL2-20D

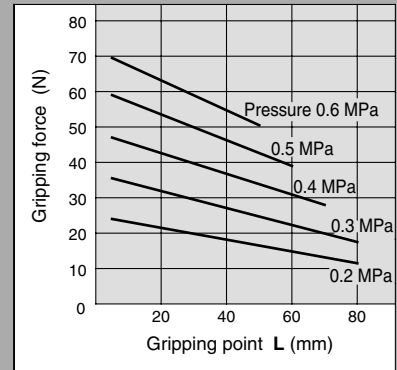

##### MHKL2-25D

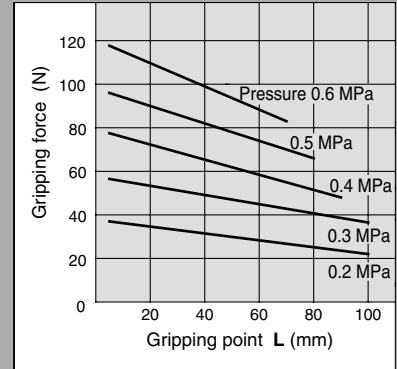

MHZ

MHF

MHL

MHR

**MHK**

MHS

MHC

MHT

MHY

MHW

-X □

MRHQ

MA

D-□

# Series MHK2

## Effective Gripping Force: Series MHK2 Single Acting

### Indication of effective gripping force

The effective gripping force shown in the graphs to the right is expressed as  $F$ , which is the thrust of one finger, when both fingers and attachments are in full contact with the work-piece as shown in the figure below.

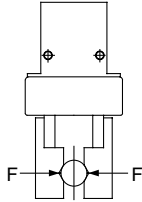

Note) In case of single acting type, the value is for stroke center.

### External grip Series MHK2

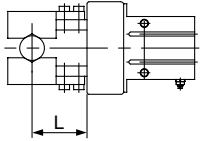

### Internal grip Series MHK2

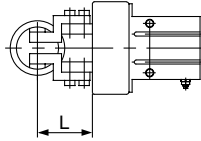

### Precautions when using the single acting type:

If a moment such as that illustrated below is applied to the finger, the finger might not be able to retract by the spring force alone. Therefore, make sure to use the air gripper within the allowable moment that is indicated in the table below.

### Allowable Moment

Model	Allowable moment (N·m)
MHK2-12S/C	0.05
MHK2-16S/C	0.12
MHK2-20S/C	0.25
MHK2-25S/C	0.49

M: Allowable moment  
( $M = WL$ )

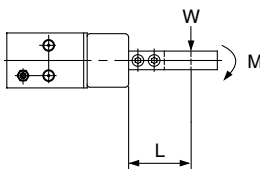

### External Grip

#### MHK2-12S

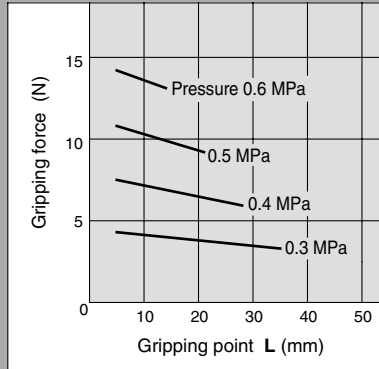

### Internal Grip

#### MHK2-12C

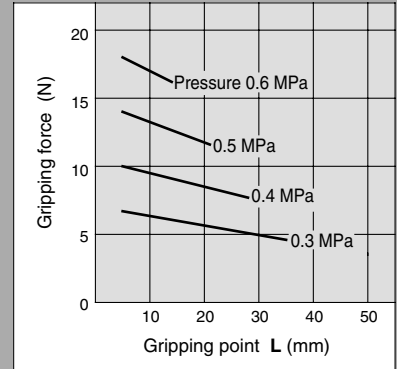

#### MHK2-16S

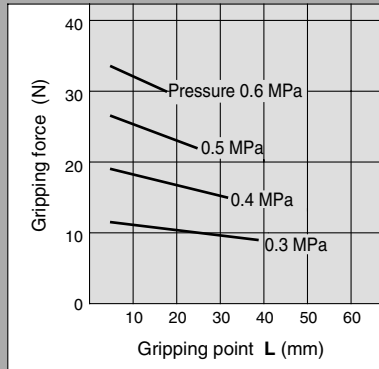

#### MHK2-16C

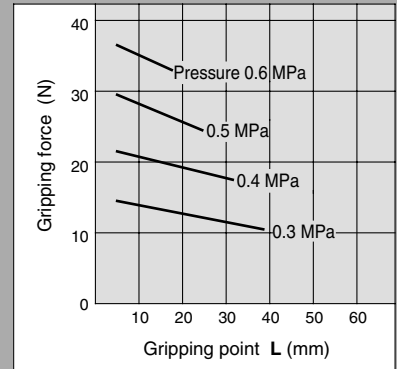

#### MHK2-20S

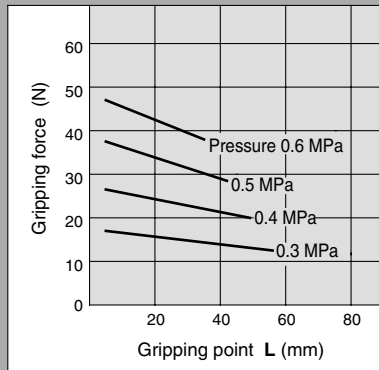

#### MHK2-20C

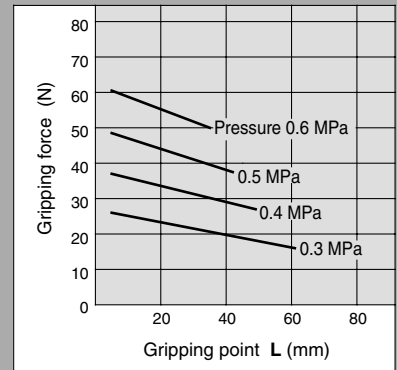

#### MHK2-25S

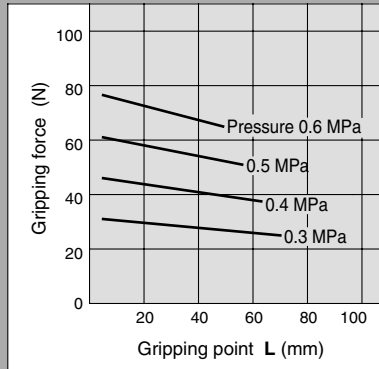

#### MHK2-25C

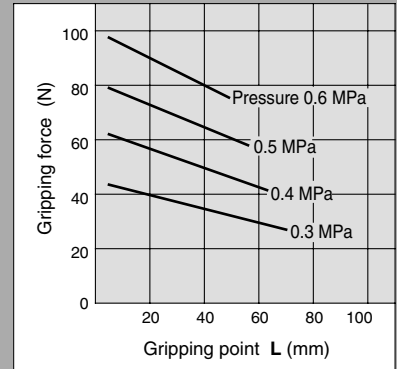

## Effective Gripping Force: Series MHKL2 Single Acting

• Indication of effective gripping force

The effective gripping force shown in the graphs to the right is expressed as F, which is the thrust of one finger, when both fingers and attachments are in full contact with the work-piece as shown in the figure below.

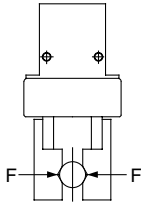

Note) In case of single acting type, the value is for stroke center.

**External grip**  
Series MHKL2

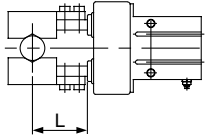

**Internal grip**  
Series MHKL2

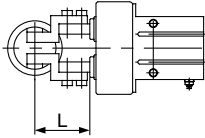

• Precautions when using the single acting type:

If a moment such as that illustrated below is applied to the finger, the finger might not be able to retract by the spring force alone. Therefore, make sure to use the air gripper within the allowable moment that is indicated in the table below.

### Allowable Moment

Model	Allowable moment (N·m)
MHKL2-12S/C	0.05
MHKL2-16S/C	0.12
MHKL2-20S/C	0.25
MHKL2-25S/C	0.49

M: Allowable moment  
( $M = WL$ )

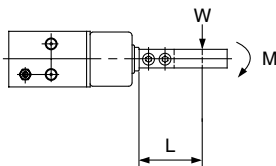

### External Grip

#### MHKL2-12S

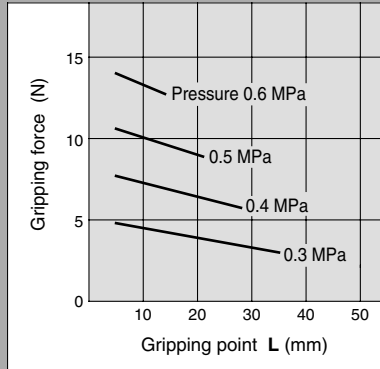

#### MHKL2-16S

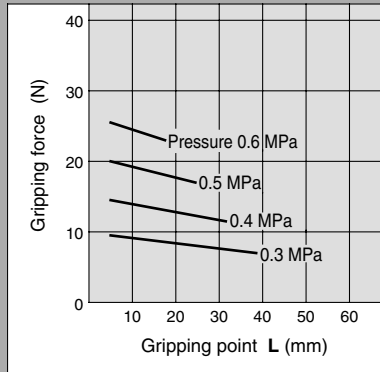

#### MHKL2-20S

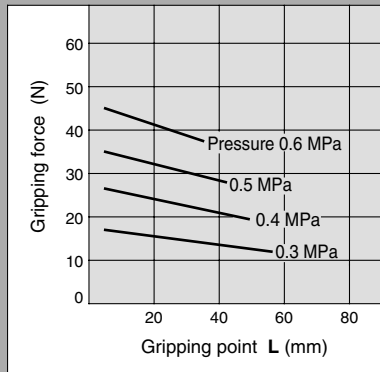

#### MHKL2-25S

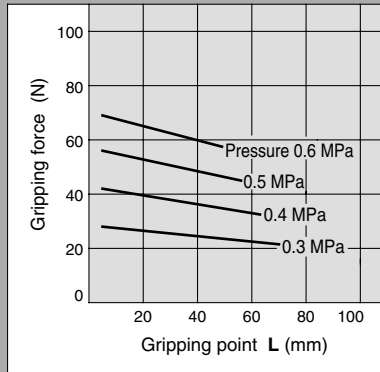

### Internal Grip

#### MHKL2-12C

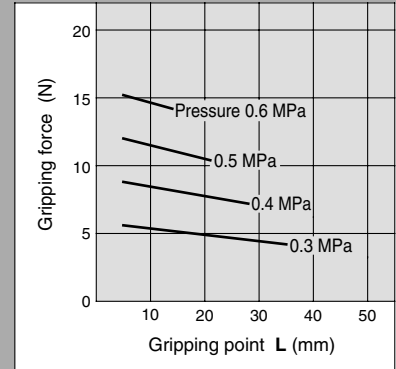

#### MHKL2-16C

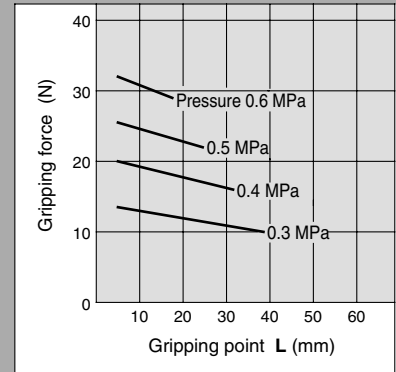

#### MHKL2-20C

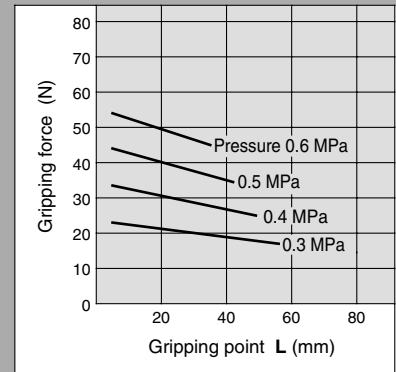

#### MHKL2-25C

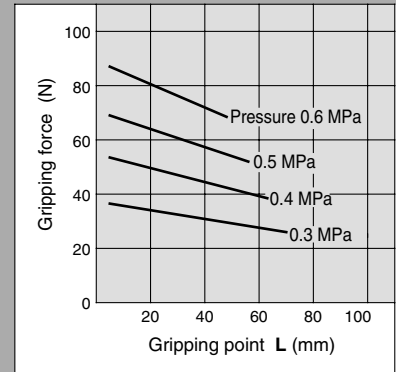

- MHZ
- MHF
- MHL
- MHR
- MHK**
- MHS
- MHC
- MHT
- MHY
- MHW
- X□
- MRHQ
- MA
- D-□

# Series MHK2

## Dimensions

### MHK2-12□: Standard type

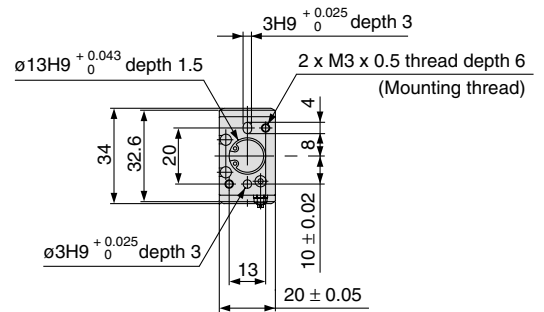
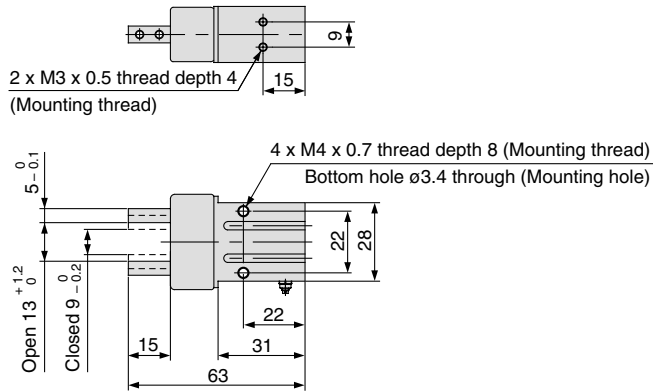

### Auto Switch Mounting Groove Dimensions

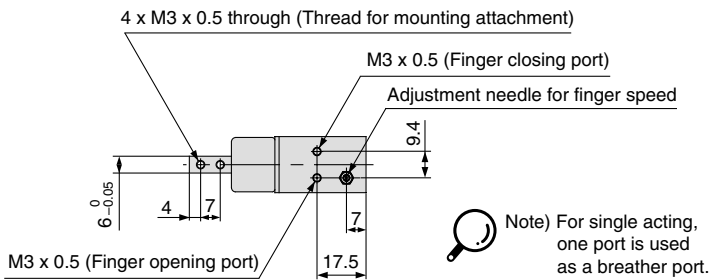
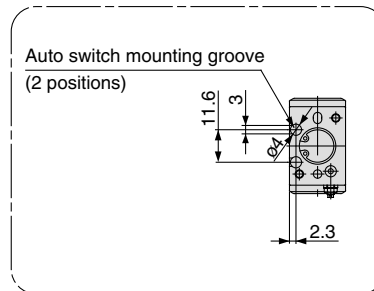

### MHKL2-12□: Long stroke type

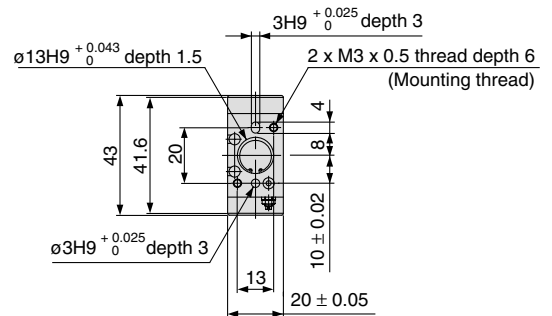
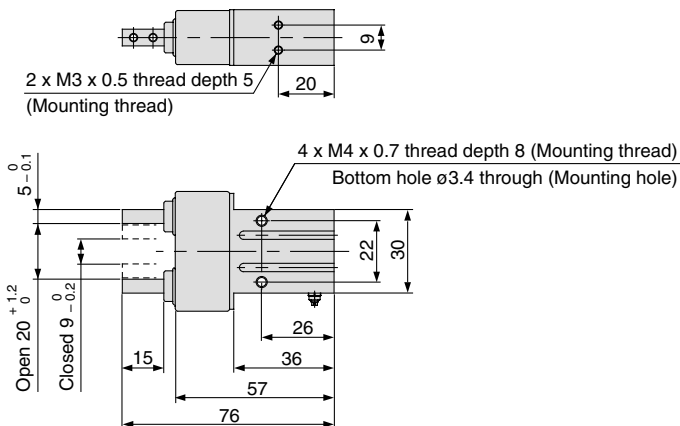

### Auto Switch Mounting Groove Dimensions

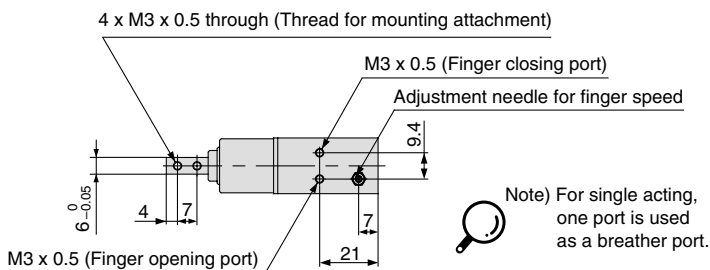
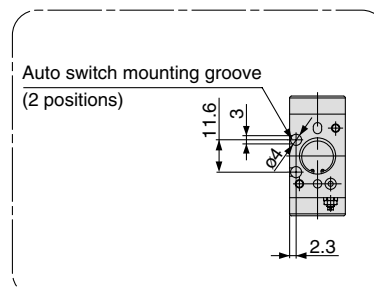

**MHK2-16□: Standard type**

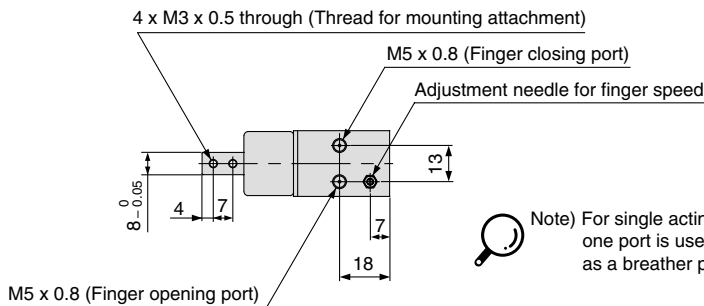
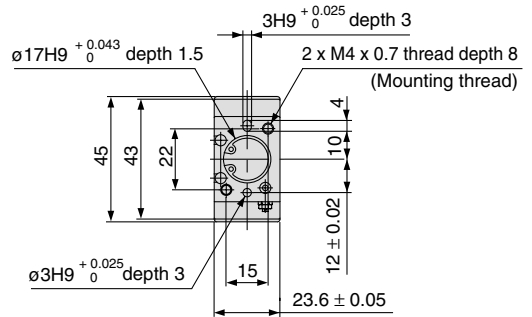
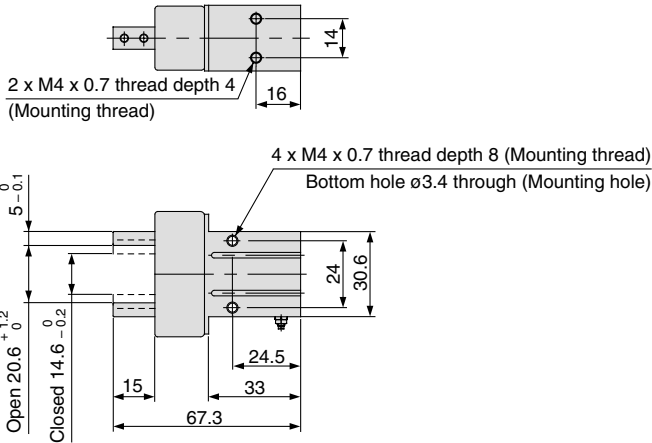

**Auto Switch Mounting Groove Dimensions**

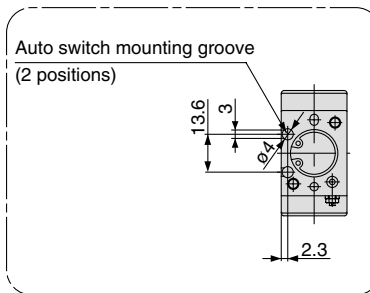

**MHKL2-16□: Long stroke type**

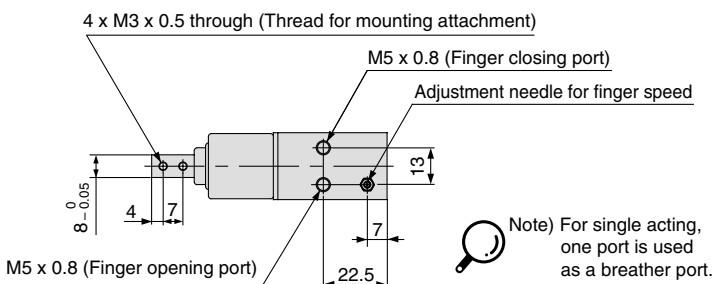
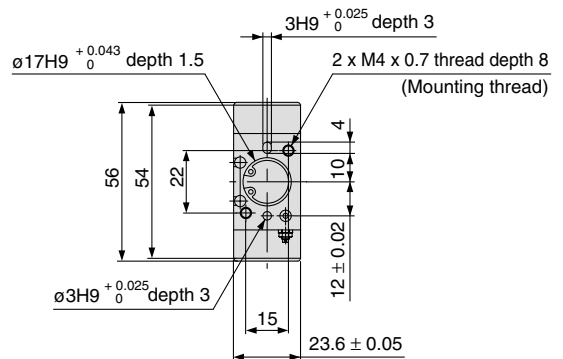
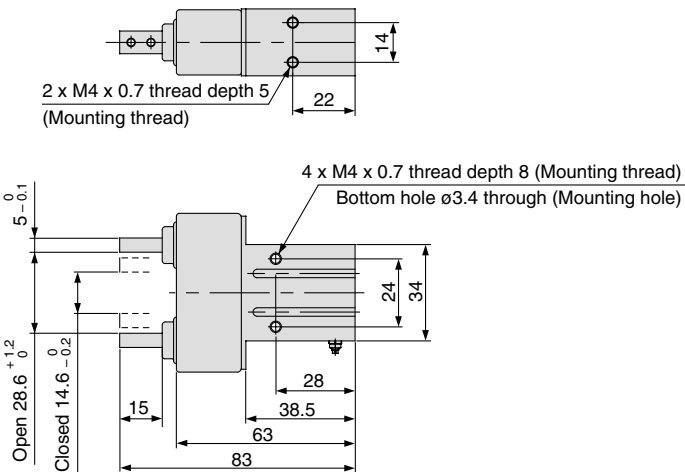

**Auto Switch Mounting Groove Dimensions**

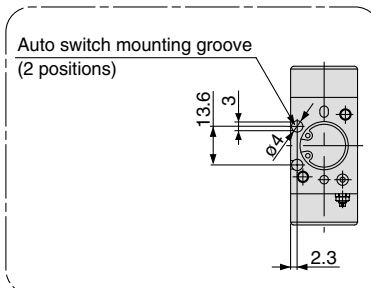

MHZ

MHF

MHL

MHR

**MHK**

MHS

MHC

MHT

MHY

MHW

-X□

MRHQ

MA

D-□

# Series MHK2

## Dimensions

### MHK2-20□: Standard type

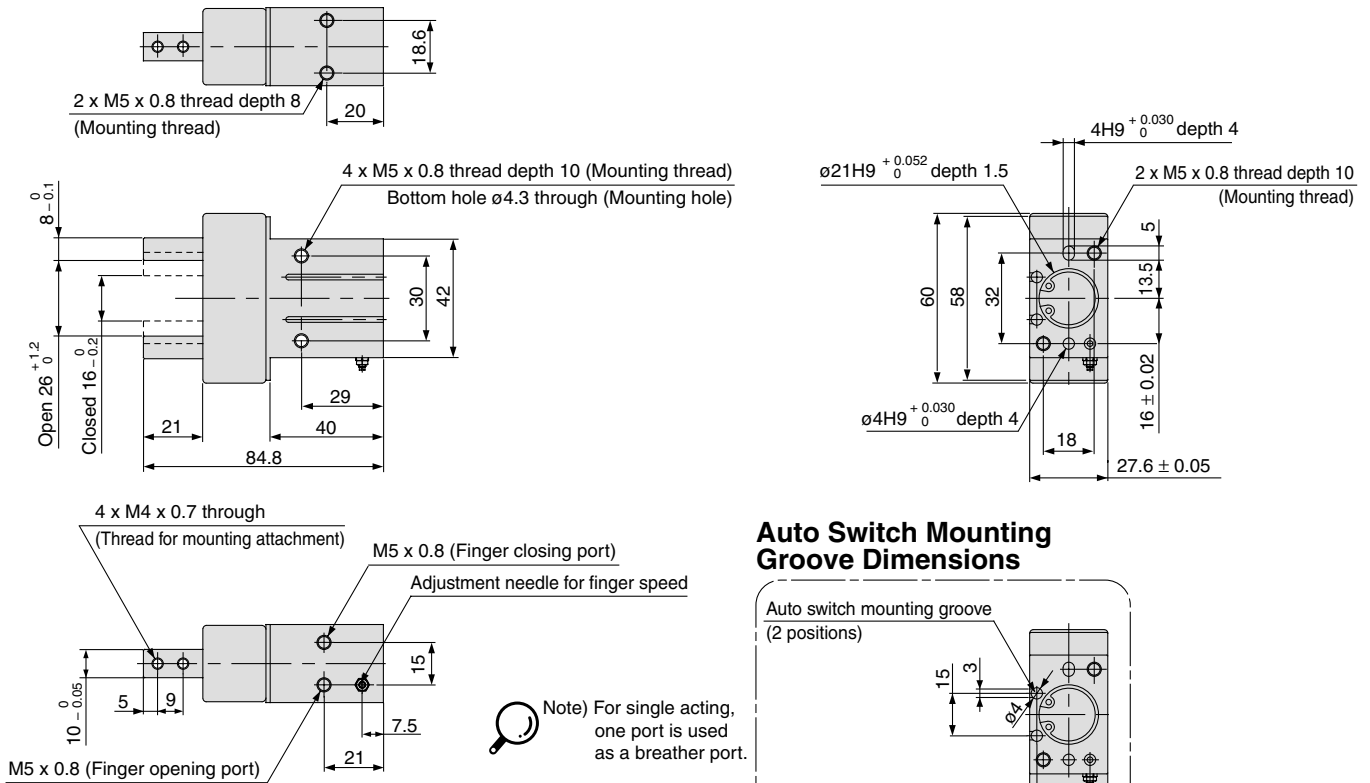

### Auto Switch Mounting Groove Dimensions

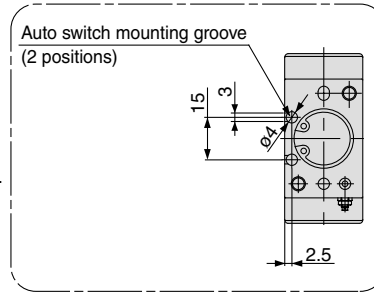

### MHKL2-20□: Long stroke type

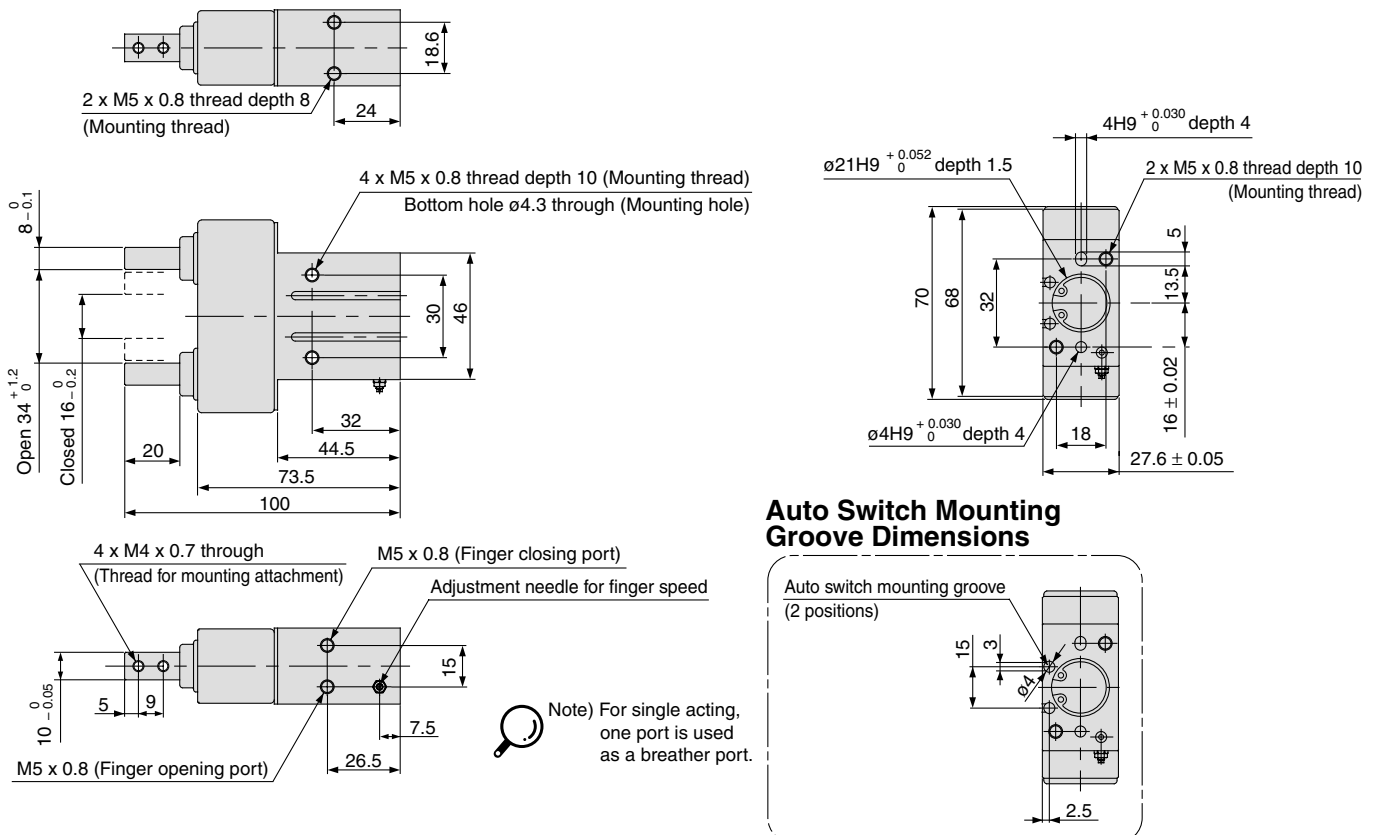

### Auto Switch Mounting Groove Dimensions

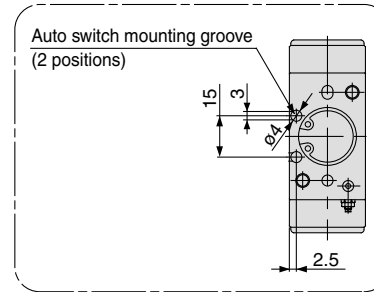

**MHK2-25□: Standard type**

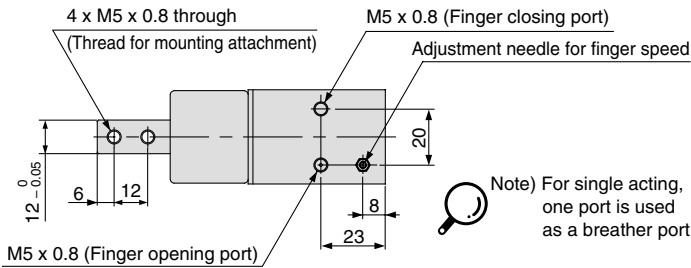
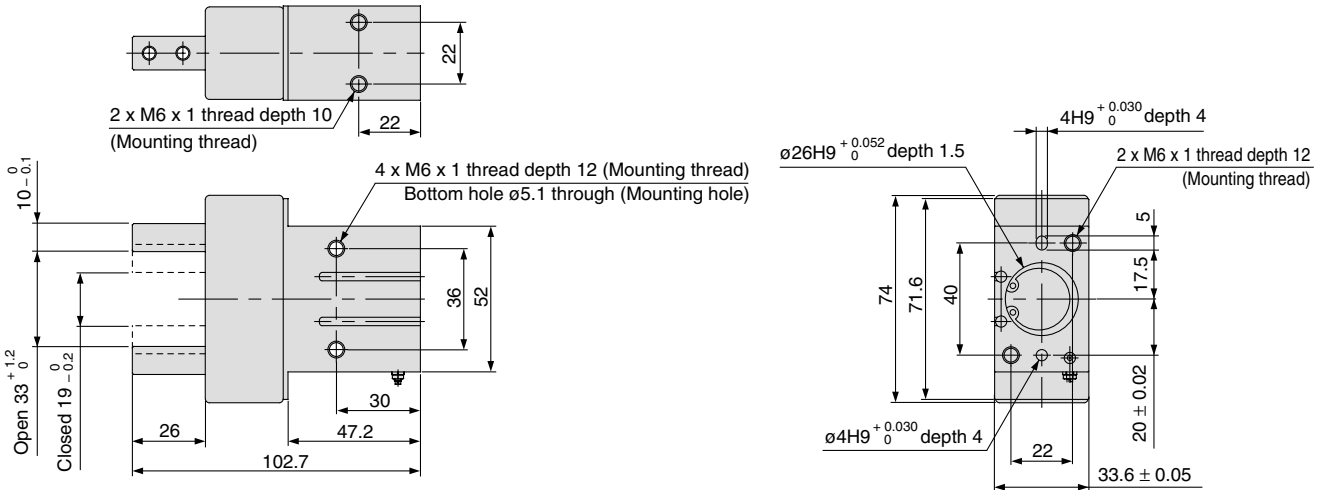

**Auto Switch Mounting Groove Dimensions**

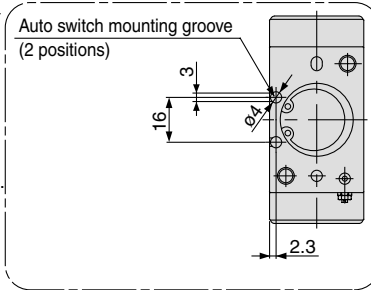

**MHKL2-25□: Long stroke type**

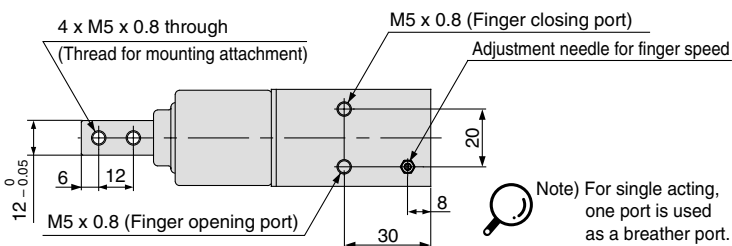
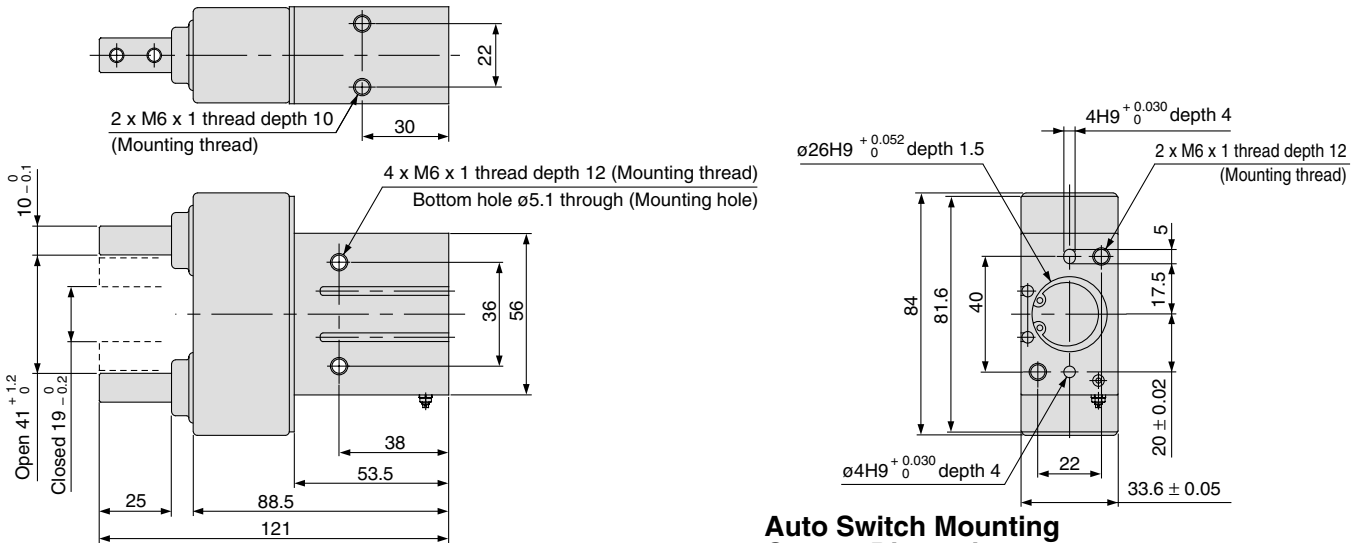

**Auto Switch Mounting Groove Dimensions**

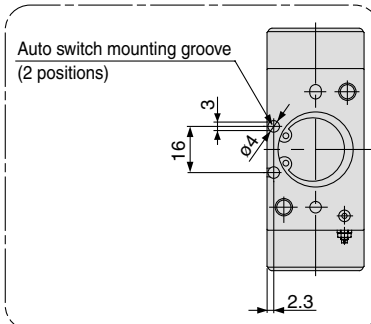

- MHZ
- MHF
- MHL
- MHR
- MHK**
- MHS
- MHC
- MHT
- MHY
- MHW
- X□
- MRHQ
- MA
- D-□

# Series *MHK2/MHKL2* Auto Switch Installation Examples and Mounting Positions

Various auto switch applications are possible through different combinations of auto switch quantities and detecting positions.

## 1) Detection when Gripping Exterior of Workpiece

Detection example		1. Confirmation of fingers in reset position	2. Confirmation of workpiece held	3. Confirmation of workpiece released	
Position to be detected		Position of fingers fully opened	Position when gripping a workpiece	Position of fingers fully closed	
Operation of auto switch		Auto switch turned ON when fingers return. (Light ON)	Auto switch turned ON when gripping a workpiece. (Light ON)	When a workpiece is held (Normal operation): Auto switch to turn OFF (Light not illuminating) When a workpiece is not held (Abnormal operation): Auto switch to turn ON (Light illuminating)	
Detection combinations	One auto switch	●	●	●	
	Two auto switches	●—●	●—●	●—●	
		●—●—●	●—●—●	●—●—●	
How to determine auto switch installation position		Step 1) Fully open the fingers.	Step 1) Position fingers for gripping a workpiece.	Step 1) Position fingers for gripping a workpiece.	
At no pressure or low pressure, connect the auto switch to a power supply, and follow the directions.		Step 2) Insert the auto switch into the auto switch installation groove in the direction shown in the following drawing.			
		Step 3) Slide the auto switch in the direction of the arrow until the indicator light illuminates.	Step 3) Slide the auto switch in the direction of the arrow until the light illuminates and fasten it at a position 0.3 to 0.5 mm in the direction of the arrow beyond the position where the indicator light illuminates.	Position where light turns ON	
		Step 4) Slide the auto switch further in the direction of the arrow until the indicator light goes out.	0.3 to 0.5 mm		
		Step 5) Move the auto switch in the opposite direction and fasten it at a position 0.3 to 0.5 mm beyond the position where the indicator light illuminates.	Position to be secured		
		Position where light turns ON		0.3 to 0.5 mm	
Position to be secured		0.3 to 0.5 mm			











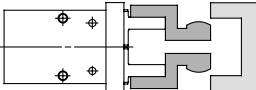
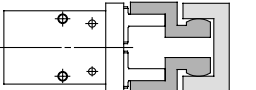
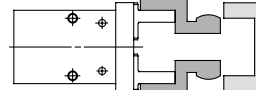

Note 1) It is recommended that gripping of a workpiece be performed close to the center of the finger stroke.

Note 2) When holding a workpiece close at the end of open/close stroke of fingers, detecting performance of the combinations listed in the above table may be limited, depending on the hysteresis of an auto switch, etc.



Various auto switch applications are possible through different combinations of auto switch quantities and detecting positions.

## 2) Detection when Gripping Interior of Workpiece

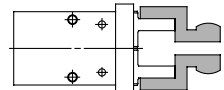
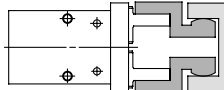
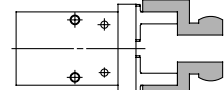
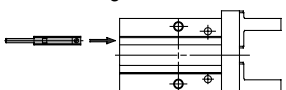
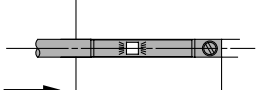
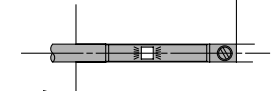
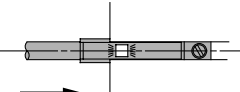
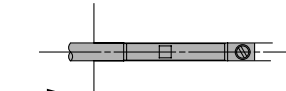
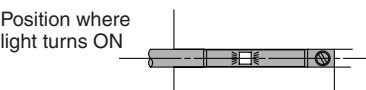
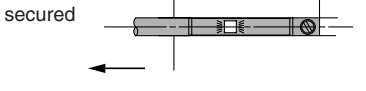
Detection example		1. Confirmation of fingers in reset position	2. Confirmation of workpiece held	3. Confirmation of workpiece released			
Position to be detected		Position of fingers fully closed 	Position when gripping a workpiece 	Position of fingers fully opened 			
Operation of auto switch		Auto switch turned ON when fingers return. (Light ON)	Auto switch turned ON when gripping a workpiece. (Light ON)	When a workpiece is held (Normal operation): Auto switch to turn OFF (Light not illuminating) When a workpiece is not held (Abnormal operation): Auto switch to turn ON (Light illuminating)			
Detection combinations	One auto switch						
	Two auto switches						
							
How to determine auto switch installation position		Step 1) Fully close the fingers. 	Step 1) Position fingers for gripping a workpiece. 	Step 1) Fully open the fingers. 			
<p>At no pressure or low pressure, connect the auto switch to a power supply, and follow the directions.</p>		Step 2) Insert the auto switch into the auto switch installation groove in the direction shown in the following drawing. 					
		<p>Step 3) Move the auto switch in the direction of the arrow and fasten it at a position 0.3 to 0.5 mm beyond the position where the indicator light illuminates.</p>  <p style="text-align: center;">0.3 to 0.5 mm</p> 	<p>Step 3) Slide the auto switch in the direction of the arrow until the indicator light illuminates.</p> 	<p>Step 4) Slide the auto switch further in the direction of the arrow until the indicator light goes out.</p> 			
		<p>Step 5) Move the auto switch in the opposite direction 0.3 to 0.5 mm in the direction indicated by the arrow from its location when the indicator light comes on again.</p>			<p>Position where light turns ON</p>  <p style="text-align: center;">0.3 to 0.5 mm</p> <p>Position to be secured</p> 		



Note 1) It is recommended that gripping of a workpiece be performed close to the center of the finger stroke.

Note 2) When holding a workpiece close at the end of open/close stroke of fingers, detecting performance of the combinations listed in the above table may be limited, depending on the hysteresis of an auto switch, etc.

# Series MHK2

## Auto Switch Hysteresis

Auto switches have hysteresis similar to micro switches. Use the table below as a guide when adjusting auto switch positions, etc.

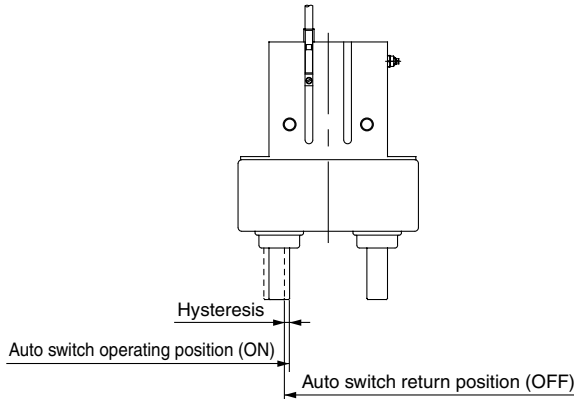

Auto switch Model	Max. hysteresis (mm)		
	D-M9□(V)	D-M9□A(V)L, M9□W(V)	
		Setting of ON position when red light is on.	Setting of ON position when green light is on.
MHK□2-12	0.1	0.1	0.3
MHK□2-16	0.1	0.1	0.3
MHK□2-20	0.3	0.3	0.8
MHK□2-25	0.2	0.2	0.6

## Auto Switch Mounting

To set the auto switch, insert the auto switch into the installation groove of the gripper from the direction indicated in the following drawing. After setting the position, tighten the attached auto switch mounting set screw with a flat head watchmaker's screwdriver.

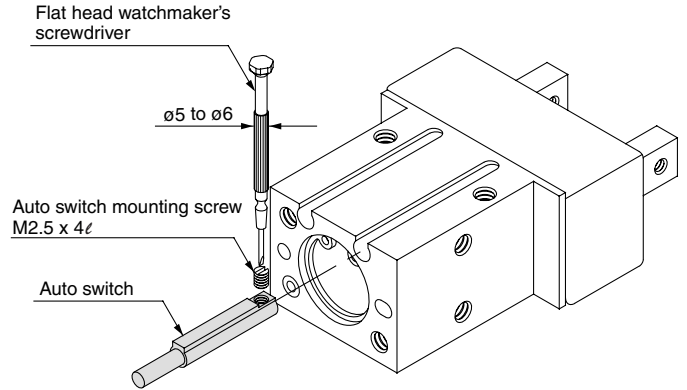

Note) Use a watchmaker's screwdriver with a grip diameter of 5 to 6 mm to tighten the auto switch mounting screw. The tightening torque should be about 0.05 to 0.15 N·m.

## Protrusion of Auto Switch from Edge of Body

- The amount of auto switch protrusion from the body's end surface is as shown in the table below.
- Use the table as a guideline for mounting.

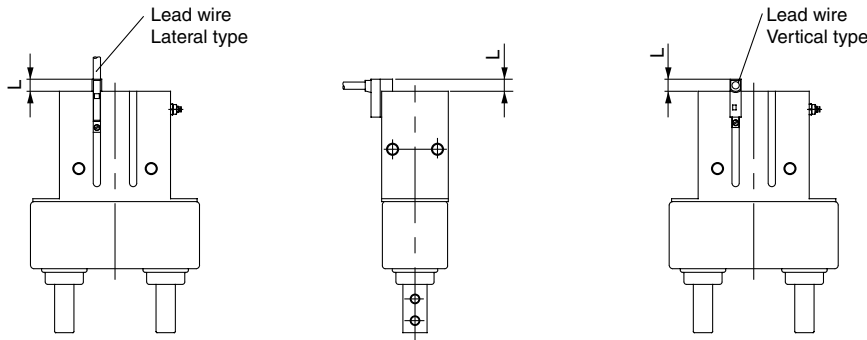

When auto switch for MHK2, MHKL2 is set on mounting side as figure below, allow for at least 1 mm on mounting plate since the auto switch is protruded from edge of gripper.

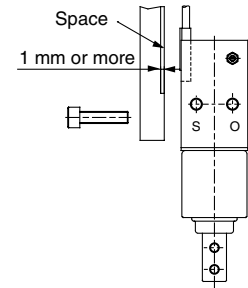

Air gripper model	Auto switch model Finger position	Lead wire type		In-line electrical entry type		Perpendicular electrical entry type	
		Lead wire type		D-M9□ D-M9□W	D-M9□AL	D-M9□V D-M9□WV	D-M9□AVL
		Lateral type	Vertical type				
MHK2-12□	Open	—	—	—	—	—	—
	Closed	3	5	—	3	—	3
MHK2-16□	Open	—	—	—	—	—	—
	Closed	3	5	1	3	—	3
MHK2-20□	Open	—	—	—	—	—	—
	Closed	1	3	—	1	—	1
MHK2-25□	Open	—	—	—	—	—	—
	Closed	2	4	—	2	—	2
MHKL2-12□	Open	—	—	—	—	—	—
	Closed	3	5	—	3	—	3
MHKL2-16□	Open	—	—	—	—	—	—
	Closed	3	5	1	3	—	3
MHKL2-20□	Open	—	—	—	—	—	—
	Closed	1	3	—	1	—	1
MHKL2-25□	Open	—	—	—	—	—	—
	Closed	1	3	—	1	—	1

Note) There is no protrusion if no values are entered in the table.



# Series *MHK2* Specific Product Precautions

Be sure to read before handling.

## Mounting Air Grippers/Series *MHK2*

Possible to mount from 3 directions.

### Axial Mounting (Body tapped)

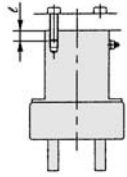

Model	Applicable bolts	Max. tightening torque N·m	Max. screw-in depth $l$ mm
MHK2 -12□ MHKL2-12□	M3 x 0.5	0.88	6
MHK2 -16□ MHKL2-16□	M4 x 0.7	2.1	8
MHK2 -20□ MHKL2-20□	M5 x 0.8	4.3	10
MHK2 -25□ MHKL2-25□	M6 x 1	7.3	12

### Vertical Mounting (Body tapped)

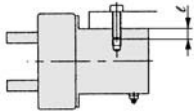

Model	Applicable bolts	Max. tightening torque N·m	Max. screw-in depth $l$ mm
MHK2 -12□ MHKL2-12□	M3 x 0.5	0.59	4
MHK2 -16□ MHKL2-16□	M4 x 0.7	0.88	4
MHK2 -20□ MHKL2-20□	M5 x 0.8	3.3	8
MHK2 -25□ MHKL2-25□	M6 x 1	5.9	10

### Lateral mounting (Body tapped and through-hole)

#### Body tapped

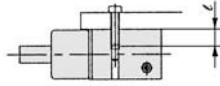

Model	Applicable bolts	Max. tightening torque N·m	Max. screw-in depth $l$ mm
MHK2 -12□ MHKL2-12□	M4 x 0.7	2.1	8
MHK2 -16□ MHKL2-16□			8
MHK2 -20□ MHKL2-20□	M5 x 0.8	4.3	10
MHK2 -25□ MHKL2-25□	M6 x 1	7.3	12

#### ●Body through-hole

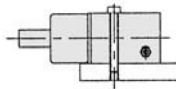

Model	Applicable bolts	Max. tightening torque N·m
MHK2 -12□ MHKL2-12□	M3 x 0.5	0.88
MHK2 -16□ MHKL2-16□		
MHK2 -20□ MHKL2-20□	M4 x 0.7	2.1
MHK2 -25□ MHKL2-25□	M5 x 0.8	4.3

### How to Mount the Attachment to the Finger

- To mount the attachment to the finger, make sure to use a wrench to support the attachment so as not to apply undue strain on the finger.
- Refer to the table below for the proper tightening torque on the bolt used for securing the attachment to the finger.

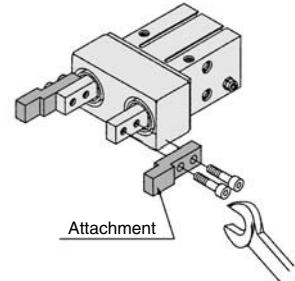

Model	Applicable bolts	Max. tightening torque N·m
MHK2 -12□ MHKL2-12□	M3 x 0.5	0.59
MHK2 -16□ MHKL2-16□		
MHK2 -20□ MHKL2-20□	M4 x 0.7	1.4
MHK2 -25□ MHKL2-25□	M5 x 0.8	2.8

MHZ

MHF

MHL

MHR

**MHK**

MHS

MHC

MHT

MHY

MHW

-X□

MRHQ

MA

D-□