

PC Wiring System

Series PCW

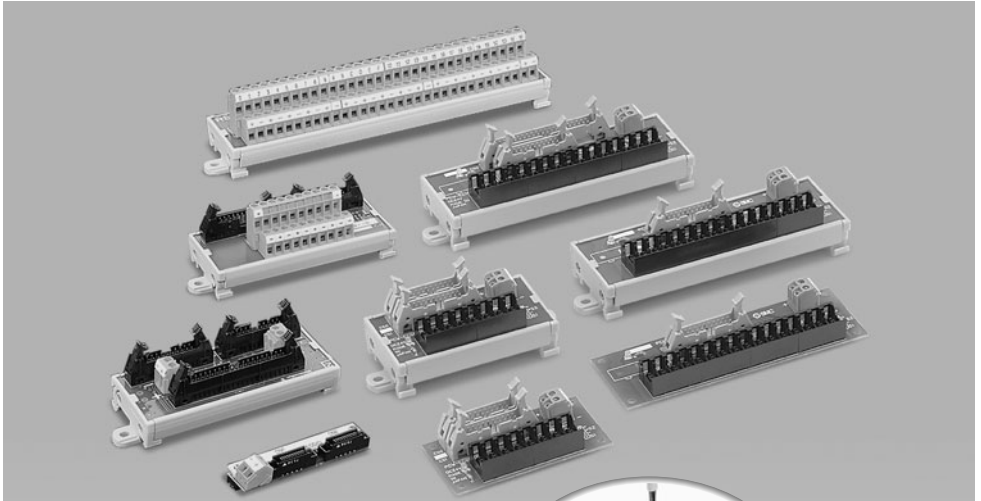

*e-con type is newly added!
One-touch connection
reduces wiring labor.*

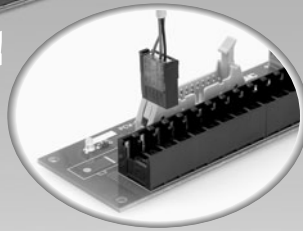

Branch unit offers commonality

- Branch unit separates each manufacturer's 32 point Input/Output (I/O) into 16 point common pin layout.
- Conversion to a common pin layout, allows connection of the pin to SMC manifold solenoid valves and other manufacturers' relay terminals without restriction.
- Power can be supplied to the PLC I/O unit.
- Compatible branch units are available for each PLC manufacturer's I/O.

Simple parallel wiring type

- Without time delay unlike serial transmission.
- Easy visual understanding at a glance, offering simple start-up, de-bug and trouble shooting maintenance.

Improved wiring efficiency and ease of operation

- Dedicated cable reduces wiring-equivalent to a serial transmission system.
- One-touch type connector offers standardized wiring to prevent incorrect connection and vastly improved operational efficiency.

Pressure Sensor

Pressure Control

Flow Sensor

Position Detection Switch

Reduced-wiring Fieldbus System

Static Electricity Elimination Equipment

Length Measuring/Counter

Alphabetical Index

A revolutionary new wiring system...

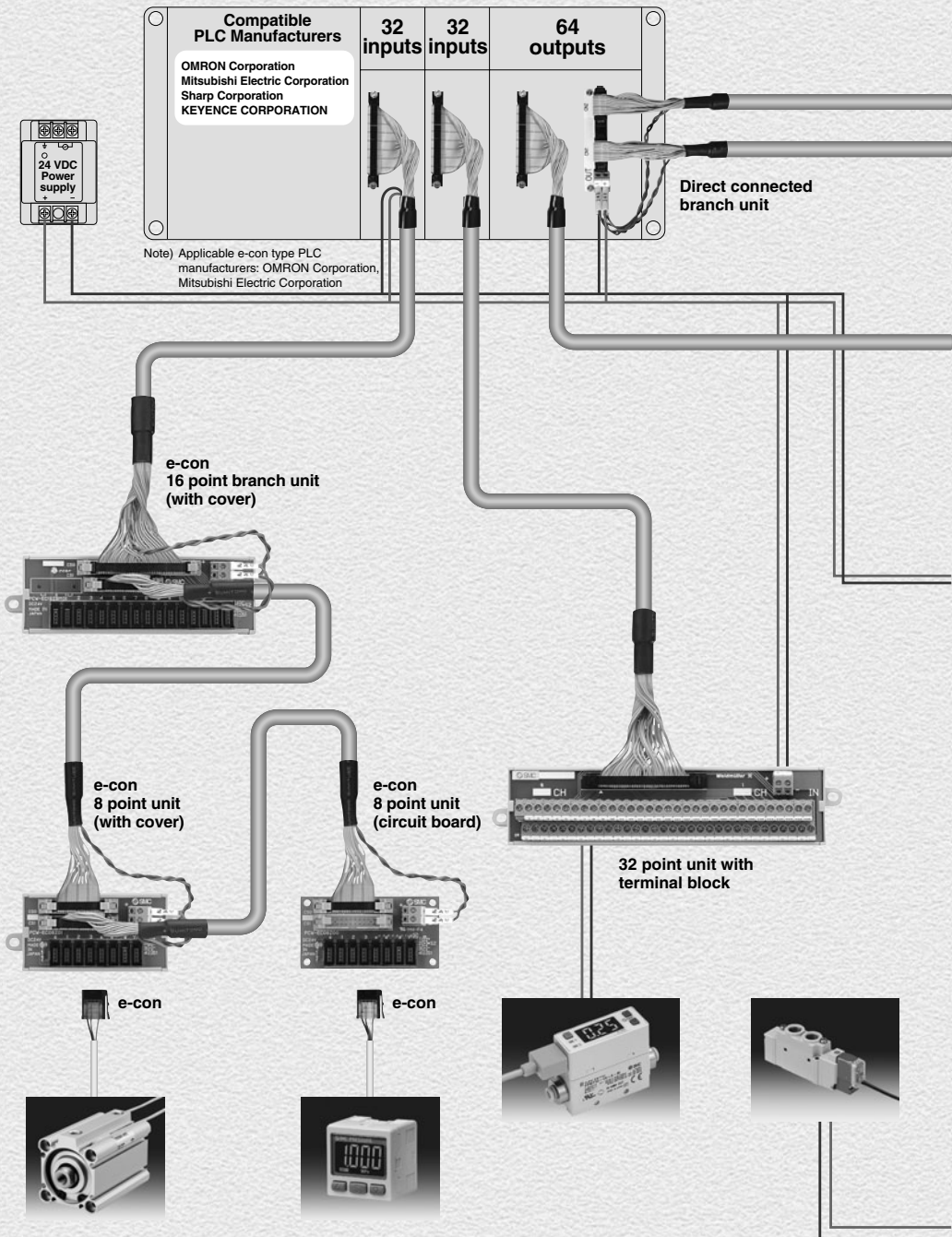

The PC wiring system simplifies wiring between a PLC and all types of connected equipment.

PC Wiring System *Series PCW*

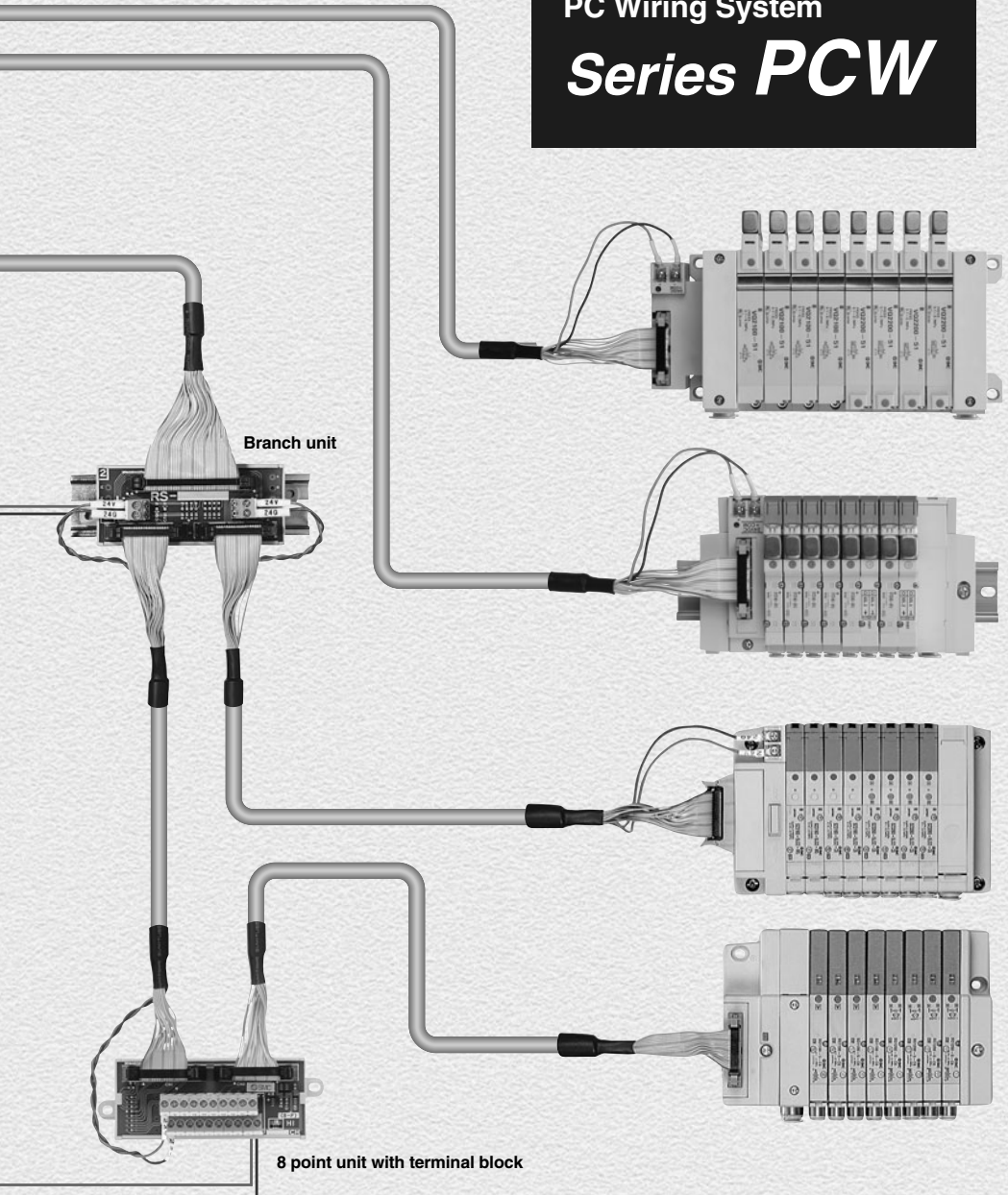

Standardized pin layout

Once 32 point terminal block unit or branch unit is replaced, no further wiring/design is necessary.

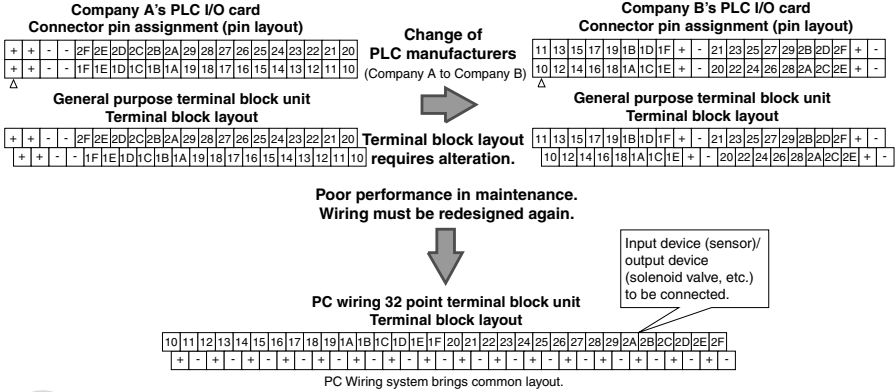

Adoption of e-con type eliminates the need for special tools and wire stripping.

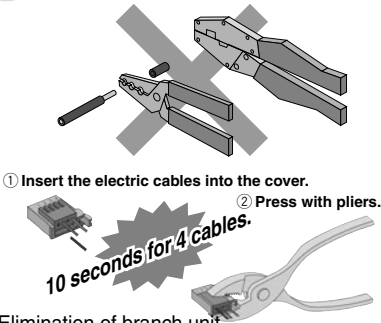

Elimination of branch unit

The function of a branch unit is built-in a 16 point unit, allowing reduction of the number of units.

[Promoted or evaluated by]
Mitsubishi Electric Corporation, OMRON Corporation, Fuji Electric Co., Ltd., Keyence Corporation, SUNX, Anywire Corporation, NKE, Kuroda Precision Industries Ltd., 3M, AMP, SMC

Common unit can be used.

Reduced spare parts enabling easier stock control.

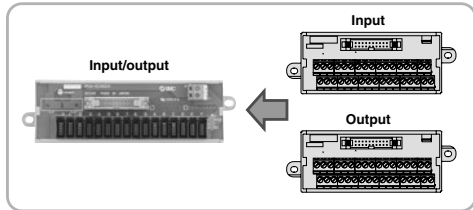

Series PCW e-CON specification

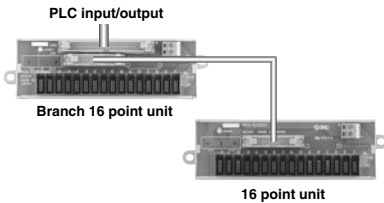

Conventional Series PCW

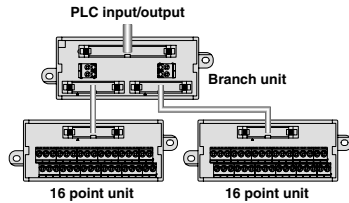

Reverse connection detection function

Visual indication of incorrect wiring of power supply terminal block and power supply status is provided.

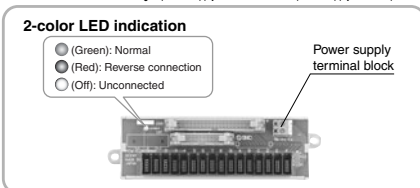

Each unit available with cover compatible with DIN rail mounting or as circuit board type.

With cover
(DIN rail mount compatible)

Circuit board type

PC Wiring / Series PCW-EC (e-con Type)

P. 589

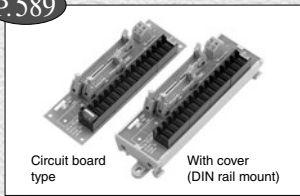

Circuit board type

With cover (DIN rail mount)

16 point branch I/O unit

Unit with e-con combines branch unit with 16 point unit.

P. 590

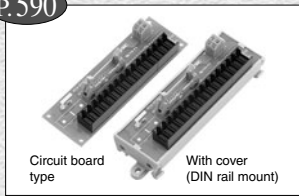

Circuit board type

With cover (DIN rail mount)

16 point I/O unit

16 point unit with e-con allows common models used for both I/O units.

P. 591

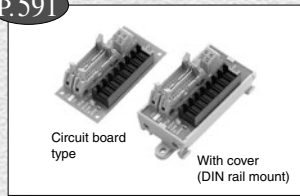

Circuit board type

With cover (DIN rail mount)

8 point I/O unit

8 point unit with e-con allows common models used for both I/O units. Can use two 8 point I/O units in a cascade connection.

PC Wiring System / Series PCW

P. 593

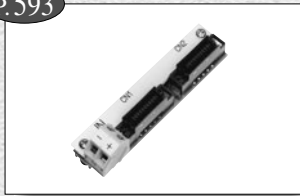

Branch unit: PLC direct connected type

Directly mounted on PLC I/O card.

P. 594

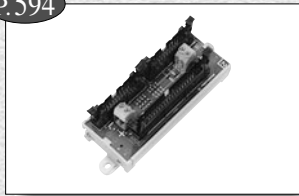

Branch unit

Connected to PLC I/O card via connection cable.

P. 599

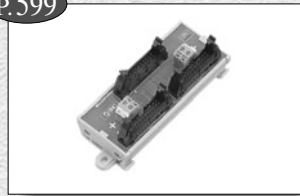

8 point branch unit

Separates two of 8 point I/O transmissions once those are separated from two of 16 point I/O by the branch unit.

P. 595



32 point I/O unit

Wired to PLC I/O card via connection cable and wires connecting equipment to the terminal blocks.

P. 596



32 point output reduced common unit

Wired to PLC I/O card via connection cable and wires connecting equipment to the terminal blocks. Products with cross-over common wires are available.

P. 598



16 point output reduced common unit

Wires two of 16 point I/O signals once separated by the branch unit to each connecting equipment via terminal block. Products with cross-over common wires are available.

P. 597

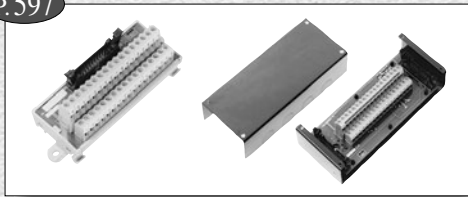

16 point I/O unit

Wires two of 16 point I/O signals once separated by the branch unit to each connecting equipment via terminal block. DIN rail mount type and box mount types are available.

P. 600

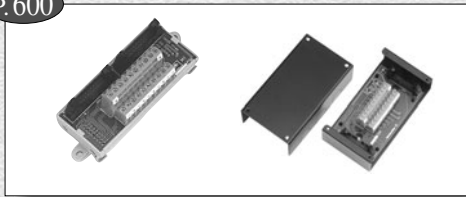

8 point I/O unit

Wires two of 16 point I/O signals once separated by the branch unit to each connecting equipment via terminal block. DIN rail mount type and box mount types are available.

Pressure Sensor

Pressure Control

Flow Sensor

Position Detection Switch

Reduced-wiring Fieldbus System

Static Electricity Elimination Equipment

Length Measuring/Counter

Alphabetical Index

PC Wiring System e-con Type Series *PCW-EC*

Common Specifications

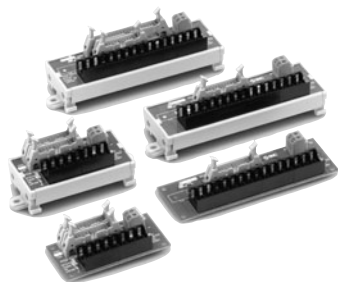

Rated voltage	24 VDC	
Rated current	Power supply line	2 A
	Communication line	0.3 A
Insulation resistance	5 MΩ or more at 100 VDC	
Withstand voltage	500 VAC	
Impact resistance	500 m/s ²	
Terminal block specifications	Screw tightening torque (Phillips head screwdriver/flat head screwdriver)	0.4 to 0.6 Nm/0.4 to 0.7 Nm
	Wire stripping length (recommended)	7 mm
	Connecting wire size	AWG26 to 14 (0.13 to 2.5 mm ²)
Input/output connector	CS0, CS1	Conforms to MIL-C-83503
	CN0 to CNF	e-con
Ambient temperature	-25 to 75°C	

e-con connector
No need for special tools
and wire stripping.

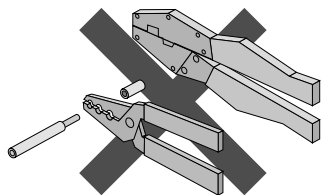

① Insert the electric cables into the cover.

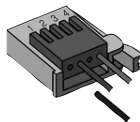

② Press with pliers.
10 seconds for 4 cables.



Weight

Model	Weight (g)
PCW-EC16ZBM00	47
PCW-EC16XBR00	
PCW-EC16YBR00	
PCW-EC16ZBM01	87
PCW-EC16XBR01	
PCW-EC16YBR01	
PCW-EC16Z00	38
PCW-EC16Z01	78
PCW-EC08Z00	31
PCW-EC08Z01	58

Option (e-con Connector)

Model		AWG No.	Cross section of conductor	Finished O.D.	Cover color
1 pc.	10 pcs./pack				
ZS-28-C	ZS-28-C-P	AWG26 to 24	0.14 to 0.2 mm ²	ø0.8 to ø1.0	Red
ZS-28-C-1	ZS-28-C-1P			ø1.0 to ø1.2	Yellow
ZS-28-C-2	ZS-28-C-2P			ø1.2 to ø1.6	Orange

Note) Applicability varies dependant on conductive construction, conductive material, and/or insulating material even resulting in inapplicable. Consult with SMC and manufacturer of connecting equipment.

16 Point Input/Output Branch Unit

Circuit board type

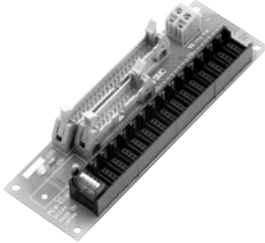

Dimensions

Circuit board type

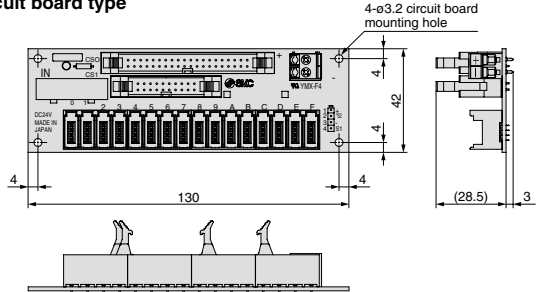

With cover
(DIN rail mount compatible)

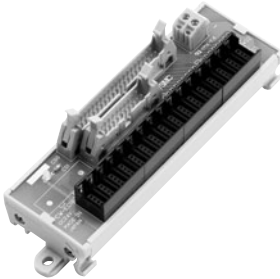

With cover (DIN rail mount compatible)

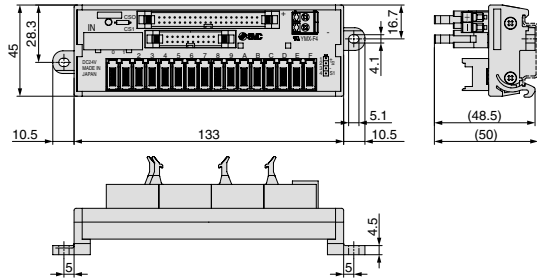

Models

Input	Output	Note
PCW-EC16XBR00	PCW-EC16YBR00	Circuit board type
PCW-EC16XBR01	PCW-EC16YBR01	With cover (DIN rail mount compatible)
PCW-EC16ZBM00		Circuit board type
PCW-EC16ZBM01		With cover (DIN rail mount compatible)

* Refer to pages 3 to 4 in CAT.02-20 about the circuit diagram.

Pressure Sensor

Pressure Control

Flow Sensor

Position Detection Switch

Reduced-wiring Fieldbus System

Static Electricity Elimination Equipment

Length Measuring/Counter

Alphabetical Index

16 Point Input/Output Unit

Circuit board type

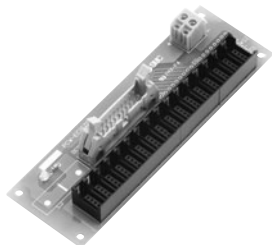

With cover (DIN rail mount compatible)



Models

PCW-EC16Z00	Circuit board type
PCW-EC16Z01	With cover (DIN rail mount compatible)

* Refer to page 5 in CAT.02-20 for the circuit diagram.

Dimensions

Circuit board type

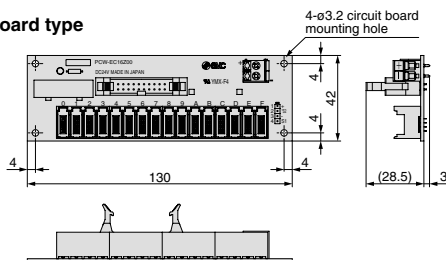

With cover (DIN rail mount compatible)

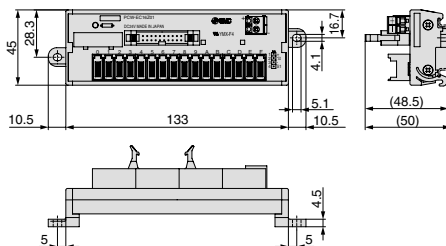

8 Point Input/Output Unit

Circuit board type

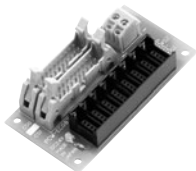

With cover (DIN rail mount compatible)

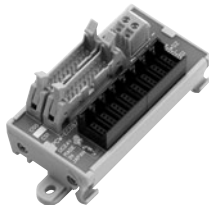

Models

PCW-EC08Z00	Circuit board type
PCW-EC08Z01	With cover (DIN rail mount compatible)

* Refer to page 6 in CAT.02-20 for the circuit diagram.

Dimensions

Circuit board type

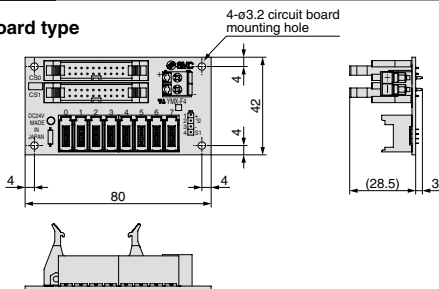

With cover (DIN rail mount compatible)

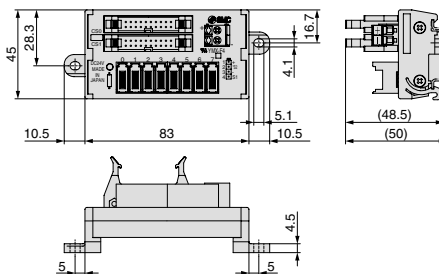

Pressure Sensor

Pressure Control

Flow Sensor

Position Detection Switch

Reduced-wiring Fieldbus System

Static Electricity Elimination Equipment

Length Measuring/Counter

Alphabetical Index

PC Wiring System

Series *PCW*

Common Specifications



Rated voltage		24 VDC	
Rated current	Power supply line	2 A	
	Communication line	0.3 A	
Insulation resistance		5 M Ω or more at 100 VDC	
Withstand voltage		0.5 kV	
Impact resistance		500 m/s ²	
Terminal block	Screw tightening torque	Power terminal (Phillips screw driver/Flat head screw driver)	0.4 to 0.6 Nm/0.4 to 0.7 Nm
		I/O terminal (Phillips screw driver/Flat head screw driver)	0.5 to 0.6 Nm/0.5 to 0.7 Nm
	Wire stripping length (recommended)	Power terminal	7 mm
		I/O terminal	
Connecting wire size	Power terminal	AWG26 to 14 (0.13 to 2.5 mm ²)	
	I/O terminal	AWG26 to 12 (0.13 to 4 mm ²)	

Cable Specifications

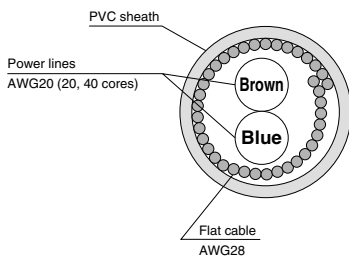

Model	With power lines		Without power lines		
	PCW-9930661H	PCW-9903491H	—		
Flat cable	20 cores	40 cores	20 cores	34 cores	40 cores
	AWG28 (7 wires/0.127 mm)				
Length	100 m roll		—		
Power lines	AWG20 (21 wires/0.18 mm)		—		
Sheath O.D.	10.3 mm	12.0 mm	8.7 mm	11.8 mm	13.0 mm

Note) The flat ribbon cable without power lines are not available from SMC.
If required, please source locally from your preferred supplier.

Branch Unit: PLC Direct Connected Type

PLC connection



➔ PLC

Can be directly mounted on PLC.

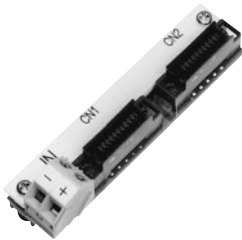

Specifications

Weight	25 g
Ambient temperature	-25 to 55°C

Note) Since the PCW series specifications are included in the common specifications, also refer to the common specifications on page 7 in CAT.E02-20.

Dimensions

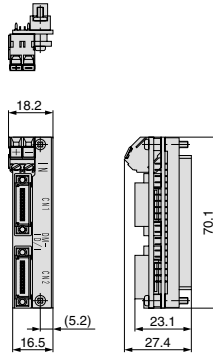

Models

Input	Output	Circuit diagram
PCW-993104	PCW-993105	Page 9 in CAT.E02-20
PCW-993106 ^{Note 1)}	PCW-993107 ^{Note 2)}	Page 10 in CAT.E02-20

Two pieces are required for 64 points of input/output.

Note 1) Combine one piece each of PCW-993106 and PCW-993108 (the PLC connection side connectors are reversed).

Note 2) Combine one piece each of PCW-993107 and PCW-993109 (the PLC connection side connectors are reversed).

⚠ Caution

When removing a cable with connector, a PCW-04T puller is required.



Pressure Sensor

Pressure Control

Flow Sensor

Position Detection Switch

Reduced-wiring Fieldbus System

Static Electricity Elimination Equipment

Length Measuring/Counter

Alphabetical Index

Branch Unit: DIN Rail Mount Type

PLC connection

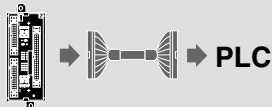

Connected to PLC via connection cable.

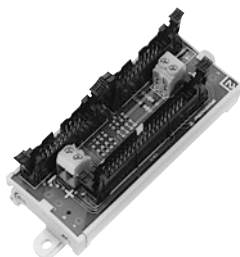

* Refer to page 50 in CAT.E02-20 for the junction cable part number.

Specifications

Weight	80 g
Ambient temperature	-25 to 80°C

Note) Since the PCW series specifications are included in the common specifications, also refer to the common specifications on page 7 in CAT.E02-20.

Dimensions

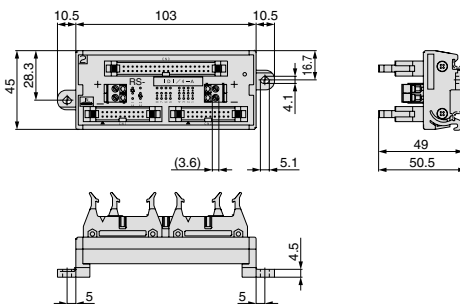

Models

Input	Output	Circuit diagram
PCW-993023A	PCW-993033A	Page 13 in CAT.E02-20
PCW-993015A	PCW-993017A	Page 14 in CAT.E02-20
PCW-993045A	PCW-993047A	Page 19 in CAT.E02-20
PCW-993139A	PCW-993140A	Page 23 in CAT.E02-20

Two pieces are required for 64 points of input/output.

Series PCW

32 Point Input/Output Unit

PLC connection

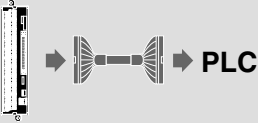

Connected to PLC via connection cable.



* Refer to page 50 in CAT.E02-20 for the junction cable part number.

Specifications

Weight	210 g
Ambient temperature	-25 to 55°C

Note) Since the PCW series specifications are included in the common specifications, also refer to the common specifications on page 7 in CAT.E02-20.

Dimensions

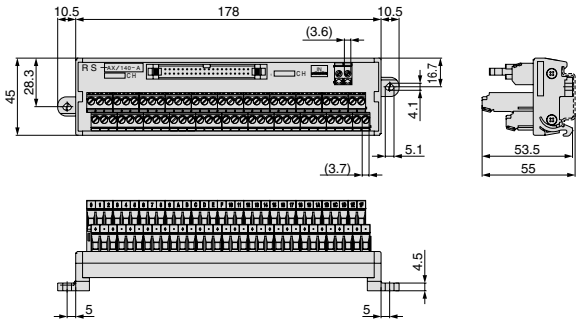

Models

Input	Output	Circuit diagram
PCW-990344A	PCW-990345A	Page 25 in CAT.E02-20
PCW-993157A	PCW-993158A	Page 26 in CAT.E02-20
PCW-993161A	PCW-993162A	Page 35 in CAT.E02-20

Two pieces are required for 64 points of input/output.

Pressure Sensor

Pressure Control

Flow Sensor

Position Detection Switch

Reduced-wiring Fieldbus System

Static Electricity Elimination Equipment

Length Measuring/Counter

Alphabetical Index

Series PCW

32 Point Output Reduced Common Unit

PLC connection

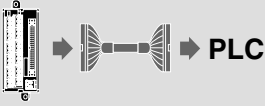

Connected to PLC via connection cable.

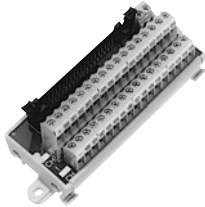

* Refer to page 50 in CAT.E02-20 for the junction cable part number.

Specifications

Weight	130 g
Ambient temperature	-25 to 55°C

Note) Since the PCW series specifications are included in the common specifications, also refer to the common specifications on page 7 in CAT.E02-20.

Dimensions

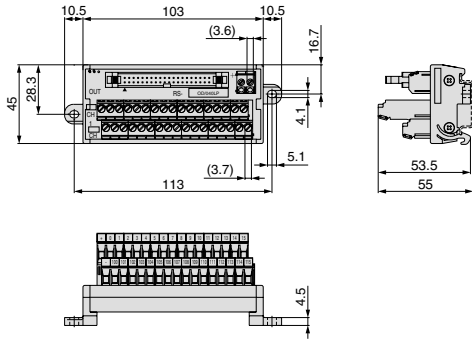

Models

Output	Circuit diagram
PCW-993193	Page 37 in CAT.E02-20
PCW-993194	Page 37 in CAT.E02-20
PCW-993225	Page 39 in CAT.E02-20

Two pieces are required for 64 points of input/output.

16 Point Input/Output Unit

Terminal Block: DIN Rail Mount Type

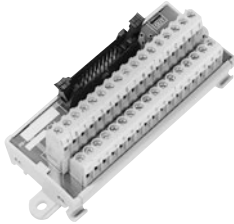

Models

Input	PCW-993051A	Circuit diagram Page 41 in CAT.E02-20
Output	PCW-993052A	Page 41 in CAT.E02-20

Specifications

Weight	125 g
Ambient temperature	-25 to 80°C

Note) Since the PCW series specifications are included in the common specifications, also refer to the common specifications on page 7 in CAT.E02-20.

Dimensions

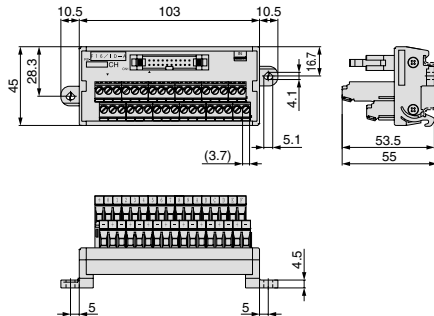

Terminal Block: Box Mount Type



Models

Input	PCW-993055A	Circuit diagram Page 42 in CAT.E02-20
Output	PCW-993056A	Page 42 in CAT.E02-20

Specifications

Weight	480 g
Ambient temperature	-25 to 80°C

Note) Since the PCW series specifications are included in the common specifications, also refer to the common specifications on page 7 in CAT.E02-20.

Dimensions

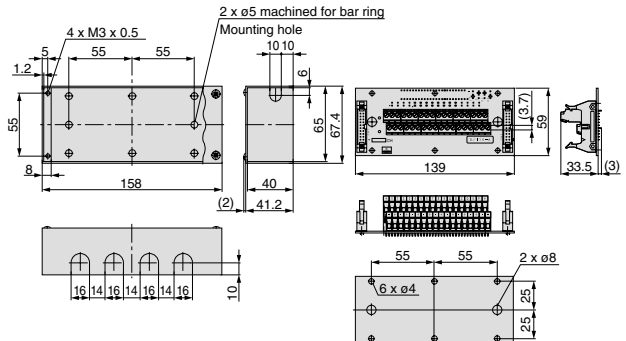

Series **PCW**

16 Point Output Reduced Common Unit

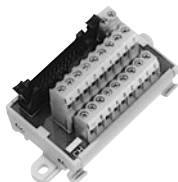

Model

Output	PCW-993195
--------	------------

* Refer to page 43 in CAT.E02-20 about the circuit diagram.

Specifications

Weight	80 g
Ambient temperature	-25 to 80°C

Note) Since the PCW series specifications are included in the common specifications, also refer to the common specifications on page 7 in CAT.E02-20.

Dimensions

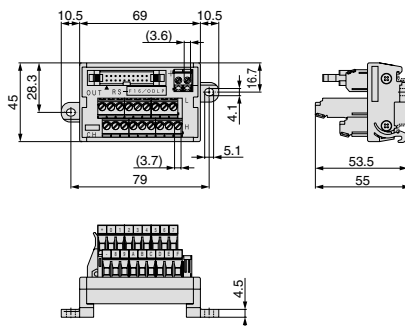

8 Point Branch Unit



Models

Input	PCW-2K0072501
Output	PCW-2K0072502

* Refer to page 44 in CAT.E02-20 about the circuit diagram.

Specifications

Weight	80 g
Ambient temperature	-25 to 80°C

Note) Since the PCW series specifications are included in the common specifications, also refer to the common specifications on page 7 in CAT.E02-20.

Dimensions

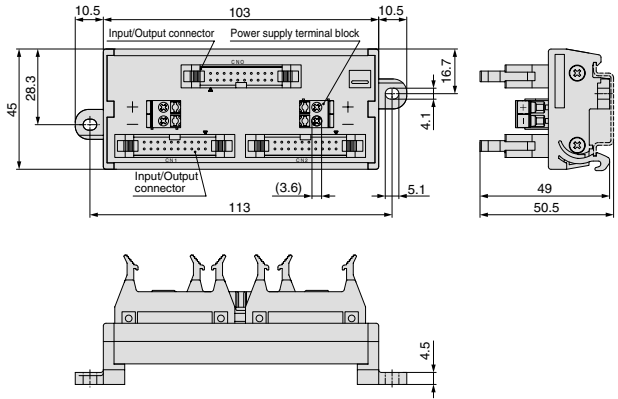

Pressure Sensor

Pressure Control

Flow Sensor

Position Detection Switch

Reduced-wiring Fieldbus System

Static Electricity Elimination Equipment

Length Measuring/Counter

Alphabetical Index

8 Point Input/Output Unit: HI/LO Setting Type

Terminal Block: DIN Rail Mount Type



Models

Input	HI	PCW-993210	Circuit diagram Page 46 in CAT.E02-20
	LO	PCW-993211	
Output	HI	PCW-993212	Circuit diagram Page 47 in CAT.E02-20
	LO	PCW-993213	

Specifications

Weight	105 g
Ambient temperature	-25 to 80°C

Note) Since the PCW series specifications are included in the common specifications, also refer to the common specifications on page 7 in CAT.E02-20.

Dimensions

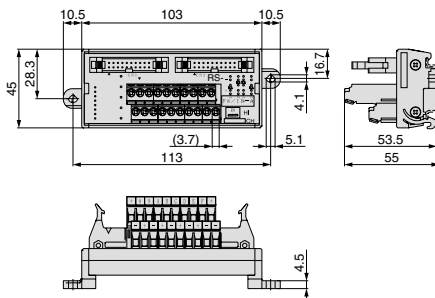

Terminal Block: Box Mount Type



Models

Input	HI	PCW-993214	Circuit diagram Page 48 in CAT.E02-20
	LO	PCW-993215	
Output	HI	PCW-993216	Circuit diagram Page 49 in CAT.E02-20
	LO	PCW-993217	

Specifications

Weight	365 g
Ambient temperature	-25 to 80°C

Note) Since the PCW series specifications are included in the common specifications, also refer to the common specifications on page 7 in CAT.E02-20.

Dimensions

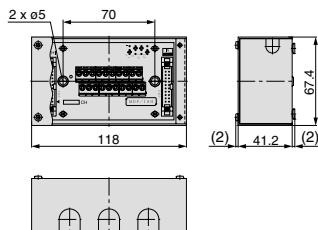

■ HI/LO setting

This type is unnecessary to set jumpers (short-circuit sockets) with fixed higher/lower (HI/LO) orders of input/output units

LO type: address assignment is fixed from "LO" 0 to 7.

HI type: address assignment is fixed from "HI" 8 to F.

Connector Cable

For Connection of PLC Input/Output Card to PCW Unit

- PLC input/output card to PCW branch unit
- PLC input/output card to PCW 32 point unit

PCW - 02 - 005

• **Lead wire length**

Symbol	Lead wire length
005	0.5 m
010	1 m
015	1.5 m
020	2 m
030	3 m
050	5 m

• **Power supply line**

Symbol	Power supply line
Nil	Yes
N	No

Contact your SMC sales representative regarding connector cables with lead wire lengths other than those in the table above.

• **Specifications**

Symbol	Specifications
02	Standard specifications
05	For connection of PCW unit compatible with KEYENCE CORP. PLC I/O card (KZ-C32X, KZ-C32T)

Dimensions

Series PCW-02

With power lines

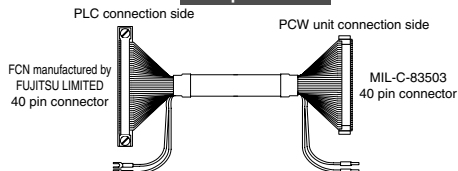

Without power lines

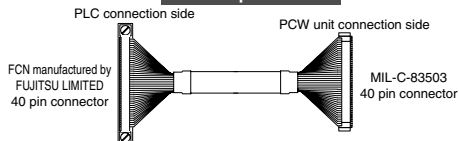

Series PCW-05

With power lines

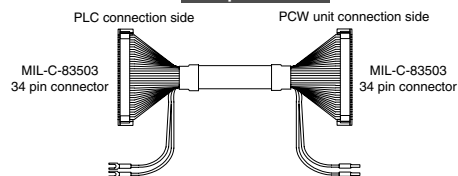

Without power lines

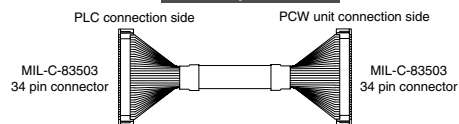

Connector Cable

Branch Unit:
Connection of PLC Direct Connecting Type to PCW Unit

- Branch unit: Connection of PLC direct connecting type to PCW 16 point unit
- Branch unit: Connection of PLC direct connecting type to PCW 8 point unit

PCW - 04 - 005

• **Lead wire length**

Symbol	Lead wire length
005	0.5 m
010	1 m
015	1.5 m
020	2 m
030	3 m
050	5 m

Contact your SMC sales representative regarding connector cables with lead wire lengths other than those in the table above.

• **Power supply lines**

Symbol	Power supply lines
Nil	Yes
N	No

Branch Unit:
Connection of PLC Direct Connecting Type to Manifold Solenoid Valves

- Branch unit: Connection of PLC direct connecting type to manifold solenoid valves

PCW - 04 V - 005

• **Lead wire length**

Symbol	Lead wire length
005	0.5 m
010	1 m
015	1.5 m
020	2 m
030	3 m
050	5 m

Contact your SMC sales representative regarding connector cables with lead wire lengths other than those in the table above.

• **Power supply lines**

Symbol	Power supply lines	Applicable manifold solenoid valve kit
V	Yes	G kit
N	No	J kit

Refer to "Best Pneumatics No. 1" for details regarding applicable manifold solenoid valves.

Dimensions

With power lines

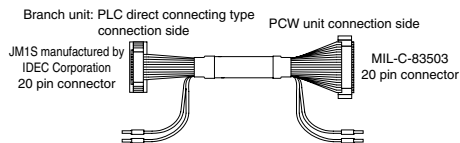

Without power lines

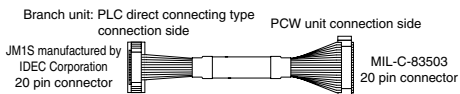

Dimensions

With power lines

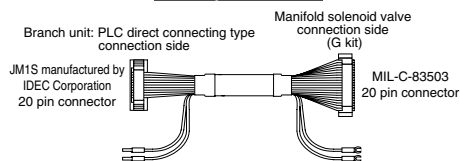

Without power lines

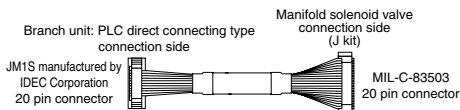

Connector Cable

Connection of PCW Unit to PCW Unit

- Connection of PCW branch unit to PCW 16 point unit
- Connection of PCW branch unit to PCW 8 point unit
- Connection of PCW 8 point unit to PCW 8 point unit

PCW-01  - **005**

• Lead wire length

Symbol	Lead wire length
005	0.5 m
010	1 m
015	1.5 m
020	2 m
030	3 m
050	5 m

Contact your SMC sales representative regarding connector cables with lead wire lengths other than those in the table above.

• Power supply lines

Symbol	Power supply lines
Nil	Yes
N	No

Connection of PCW Unit to Manifold Solenoid Valves

- Connection of PCW branch unit to manifold solenoid valves
- Connection of PCW 8 point unit to manifold solenoid valves

PCW-01 **V** - **005**

• Lead wire length

Symbol	Lead wire length
005	0.5 m
010	1 m
015	1.5 m
020	2 m
030	3 m
050	5 m

Contact your SMC sales representative regarding connector cables with lead wire lengths other than those in the table above.

• Power supply lines

Symbol	Power supply lines	Applicable manifold solenoid valve kit
V	Yes	G kit
N	No	J kit

Refer to "Best Pneumatics No. 1" for details regarding applicable manifold solenoid valves.

Dimensions

With power lines

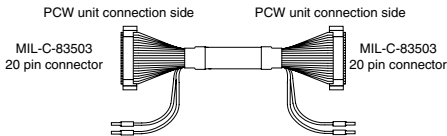

Without power lines

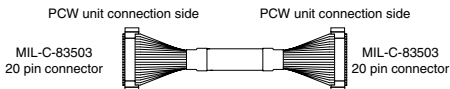

Dimensions

With power lines

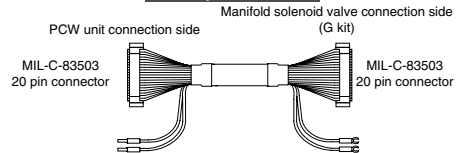

Without power lines

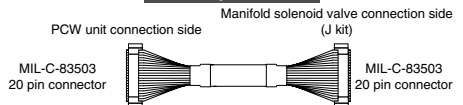



Series PCW

PC Wiring System Precautions 1

Be sure to read before handling. Refer to back page 1 for Safety Instructions.

Operation

Warning

- 1. This product is intended for use in general FA equipment. Avoid using this product in machinery or equipment which directly affects human lives or where malfunction or failure can cause extended damage.**
- 2. Do not disassemble this product for repair or rebuilding.**

Mounting, Adjustment & Wiring

Caution

- 1. Do not drop or bump.**
Do not drop, bump or apply excessive impacts (500 m/s² or more) during handling. The PC wiring system unit can be damaged and connected equipment may malfunction.
- 2. Be careful of incorrect wiring.**
Incorrect wiring may result in damage to connected equipment. The power supply will be short circuited if inputs and outputs are connected incorrectly for the 8 point/16 point input/output units following a branch unit.
- 3. Do not wire with power lines or high voltage lines.**
To prevent the intrusion of noise and surge from power and high voltage lines into signal lines, perform wiring for the PC wiring system separately (separate conduits) from power lines and high voltage lines.
- 4. Confirm proper insulation of wiring.**
Faulty insulation (crossed wiring, insulation defects between terminals, etc.) may result in damage to connected equipment, due to the application of excessive voltage or current flowing to the equipment.
- 5. Tighten screws with the proper tightening torque.**
If tightened beyond the tightening torque range, the terminal block and screws may be damaged.
- 6. Avoid subjecting cables to repeated bending or pulling forces.**
Wiring installations which result in repeated bending stress and pulling force on cables can cause broken wires.
- 7. Note that the disposition of I/O addresses differs for each PLC manufacturer.**
General purpose label sets (applicable to all manufacturers) are included, which can be cut as needed and inserted into the terminal label holders.
- 8. Operate within the rated current.**
The maximum current capacity for the power supply line on circuit boards of all units is 2.0 A. If the current passing through units such as the branch unit and input/output unit exceeds 2.0 A, connect the power supply line to the same power supply terminal and do not allow current to pass through the circuit board.

Design & Selection

Caution

- 1. Confirm the specifications.**
Use properly after confirming the specifications. Operation outside the range of specifications (voltage, ambient temperature, impact, etc.) can cause damage, malfunction or fire.
- 2. Ensure sufficient clearance for maintenance activities.**
When designing an application, be sure to allow sufficient clearance for maintenance and inspections.

Operating Environment

Caution

- 1. Absolutely do not use in an atmosphere with explosive gas.**
The PC wiring system is not an explosion-proof construction. Never use in an atmosphere with an explosive gas since this may cause a serious explosion.
- 2. Do not use in an environment with temperature cycles.**
Temperature cycles other than found with normal temperature changes may adversely affect the PC wiring system unit.
- 3. Do not use in an area where surges are generated.**
If there are devices or equipment that generate large surges (magnetic lifter, high-frequency induction furnace, motor, etc.) near the connected equipment or PC wiring system unit, the connected equipment may deteriorate or be damaged. Consider appropriate measures for any source of power surges and take care with crossed lines.
- 4. Keep wire scraps and other extraneous material from getting inside this product.**
This can cause fire, failure or malfunction, etc. Keep wire scraps and other extraneous material from getting inside this product.
- 5. Use with consideration for an operating environment with a protective structure.**
Avoid using the PC wiring system unit where water or oil is splashed.

Maintenance & Inspection

Caution

- 1. To prevent unintended malfunctioning, perform maintenance regularly.**
Unintended malfunctioning and misoperation may result in an inability to ensure safety.
- 2. Do not touch the terminals or internal boards when current is being supplied.**
Touching terminals or internal boards when current is being supplied may result in malfunctioning or damage with the PC wiring system unit or connected equipment, or electric shock.



Series PCW

PC Wiring System Precautions 2

Be sure to read before handling. Refer to back page 1 for Safety Instructions.

Design & Selection

Warning

1. Only the output specification unit can be selected when combining each unit of Series PCW and Series PCW-EC.

Please note: If an input specification unit is used, this may cause damage and/or possible burnout of any connected equipment.

When used for PLC output card

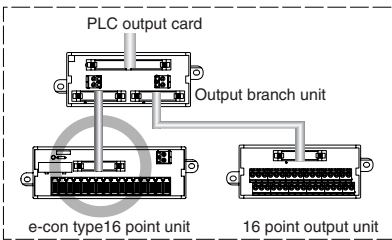
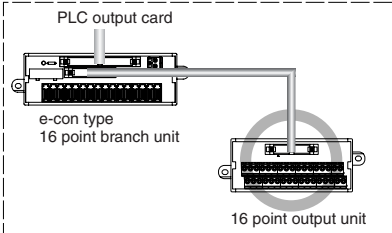

When used for PLC input card

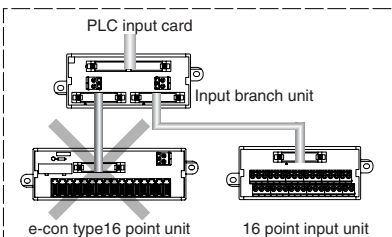
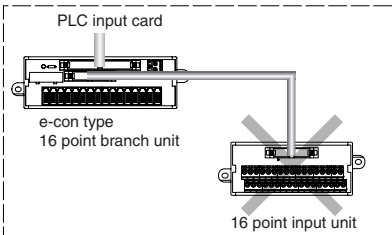

Pressure Sensor

Pressure Control

Flow Sensor

Position Detection Switch

Reduced-wiring Fieldbus System

Static Electricity Elimination Equipment

Length Measuring/Counter

Alphabetical Index